

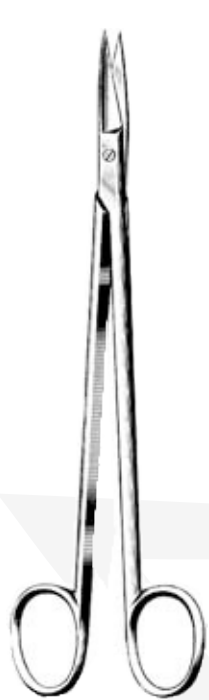

Scalpel





Kelly
16 cm / 6½"
SKL-049-16



Prince
18 cm / 7"
AE 02-051-18

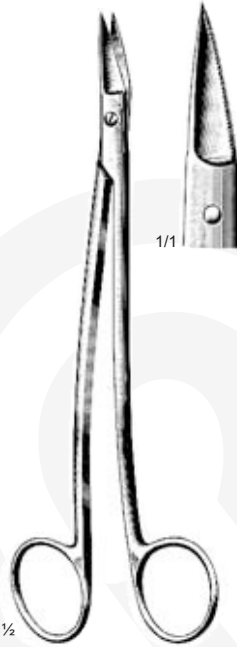

Dean
17 cm / 6¾"
SKL-053-17



12 cm / 4¾"



SKL-055-12



SKL-057-12



SKL-059-12



SKL-061-12

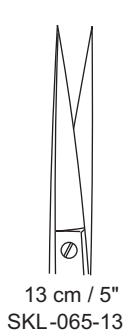

13 cm / 5"
SKL-065-13

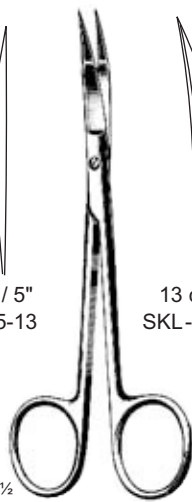

Wagner
13 cm / 5"

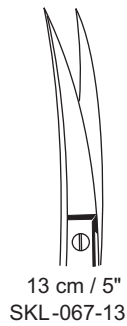

13 cm / 5"
SKL-067-13

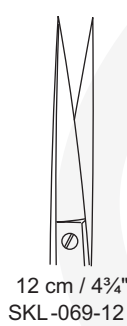

12 cm / 4¾"
SKL-069-12

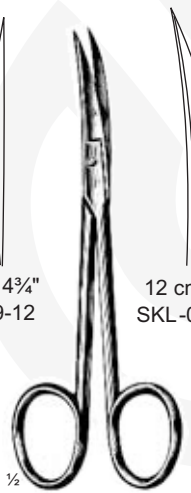

Wagner
12 cm / 4¾"

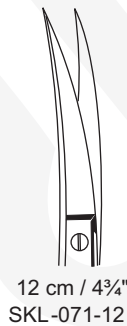

12 cm / 4¾"
SKL-071-12



11.5 cm / 4½"
SKL-073-11
Straight

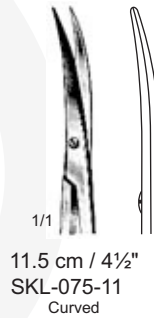

11.5 cm / 4½"
SKL-075-11
Curved

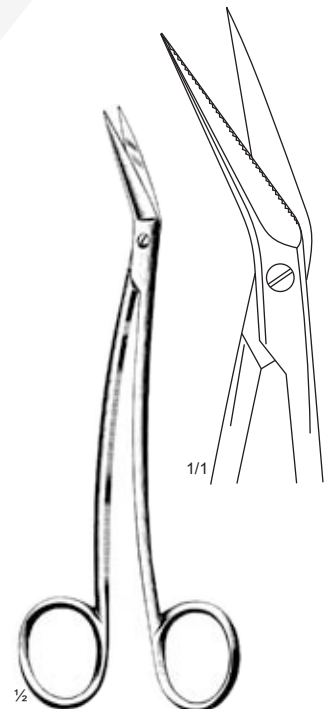

Locklin
16 cm / 6¼"
SKL-077-16
Saw edge

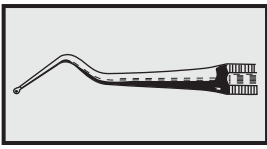

SCHWERER MODELL



1/1

1

SKL-001-01



1/1

2

SKL-001-02



1/1

3

SKL-001-03



1/1

4

SKL-001-04



1/1

5

SKL-001-05



1/1

6

SKL-001-06



1/1

7

SKL-001-07



1/1

8

SKL-001-08



1/1

9

SKL-001-09



1/1

10

SKL-001-10



1/1

11

SKL-001-11



1/1

12

SKL-001-12



1/1

SKL-003-01
Nerve Probe

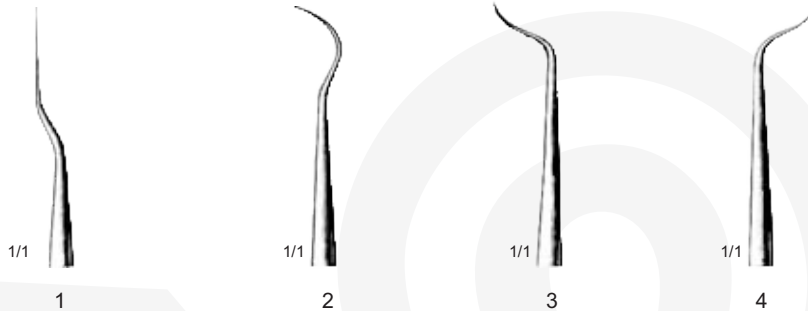
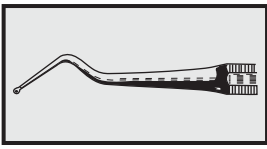

	1	2	3	4
A	SKL-005-01	SKL-005-02	SKL-005-03	SKL-005-04
B	SKL-007-01	SKL-007-02	SKL-007-03	SKL-007-04



	5	5a	6	6a
A	SKL-005-05	SKL-005-55	SKL-005-06	SKL-005-66
B	SKL-007-05	SKL-007-55	SKL-007-06	SKL-007-66

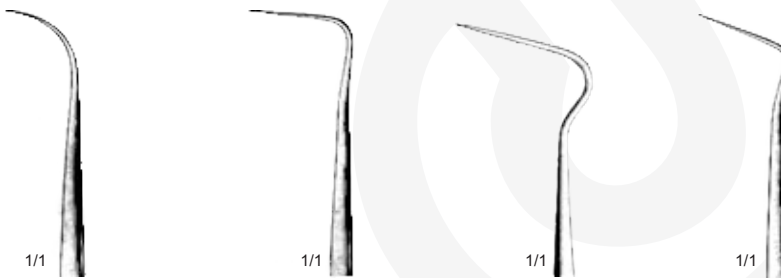

	7	8	8a	9
A	SKL-005-07	SKL-005-08	SKL-005-88	SKL-005-09
B	SKL-007-07	SKL-007-08	SKL-007-88	SKL-007-09

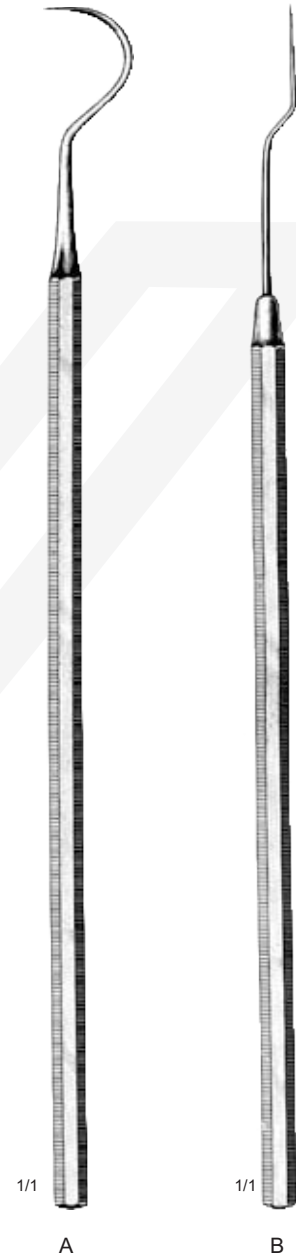

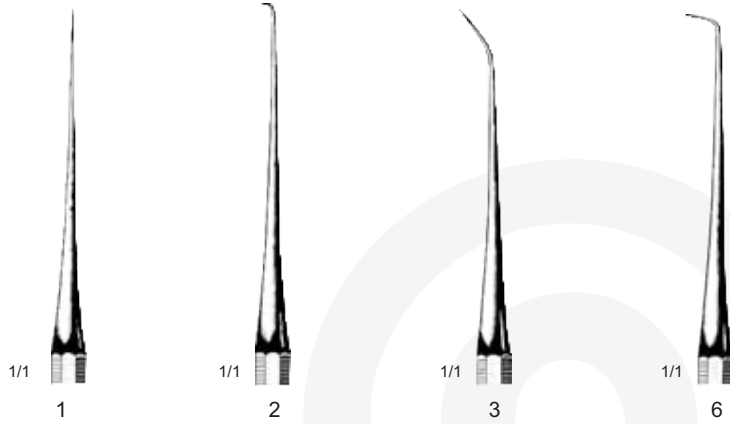
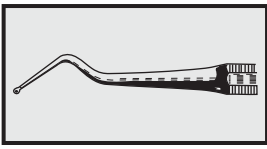

White

A	SKL-009-01	SKL-009-02	SKL-009-03	SKL-009-06
B	SKL-011-01	SKL-011-02	SKL-011-03	SKL-011-06
C	SKL-013-01	SKL-013-02	SKL-013-03	SKL-013-06

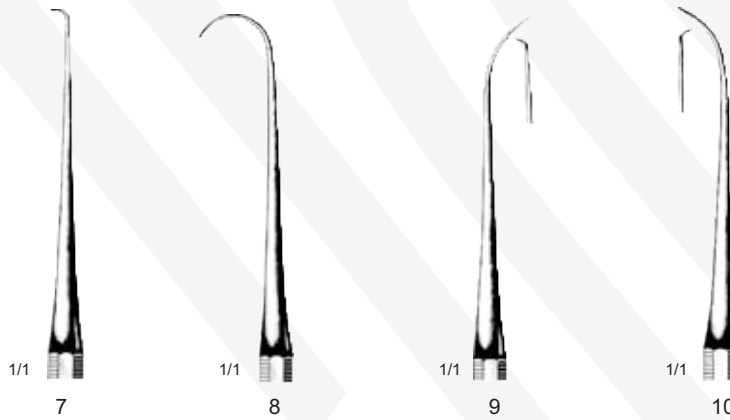

White

A	SKL-009-07	SKL-009-08	SKL-009-09	SKL-009-10
B	SKL-011-07	SKL-011-08	SKL-011-09	SKL-011-10
C	SKL-013-07	SKL-013-08	SKL-013-09	SKL-013-10

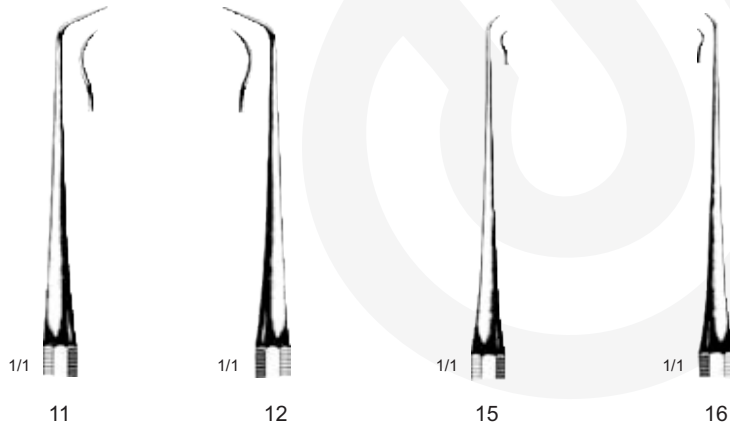

White

A	SKL-009-11	SKL-009-12	SKL-009-15	SKL-009-16
B	SKL-011-11	SKL-011-12	SKL-011-15	SKL-011-16
C	SKL-013-11	SKL-013-12	SKL-013-15	SKL-013-16

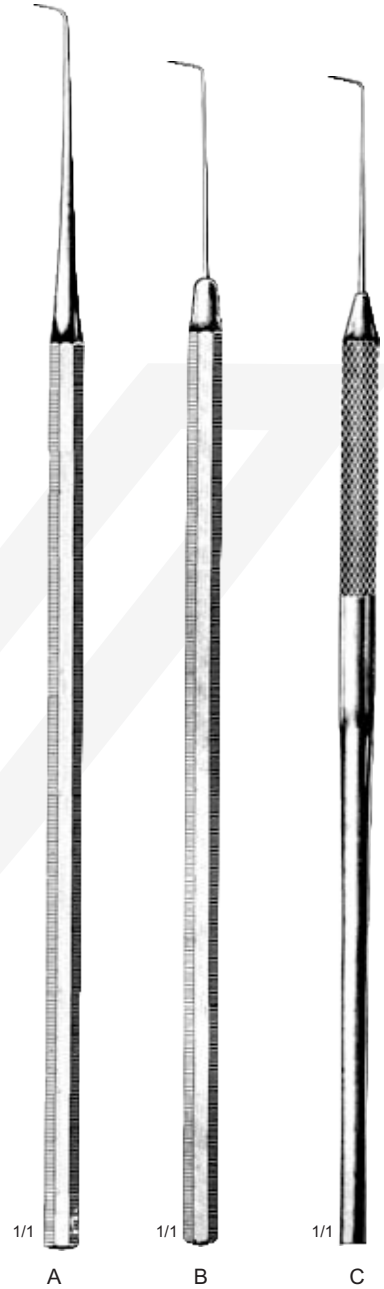

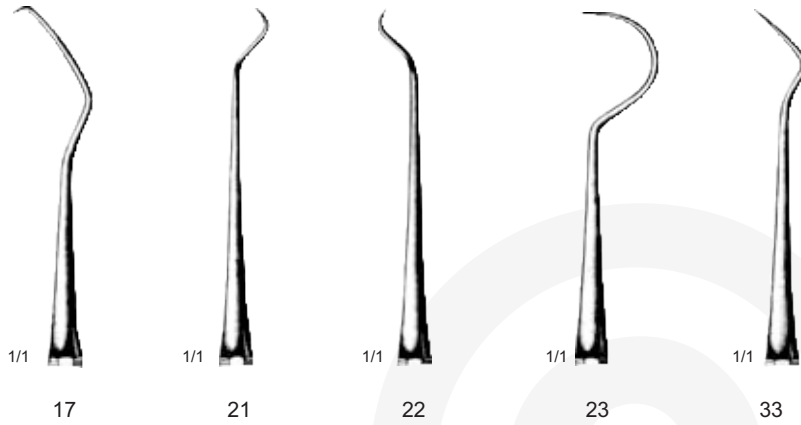
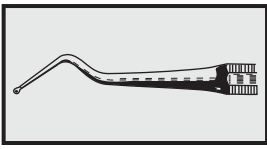

White

A	SKL-015-17	SKL-015-21	SKL-015-22	SKL-015-23	SKL-015-33
B	SKL-016-17	SKL-016-21	SKL-016-22	SKL-016-23	SKL-016-33
C	SKL-017-17	SKL-017-21	SKL-017-22	SKL-017-23	SKL-017-33

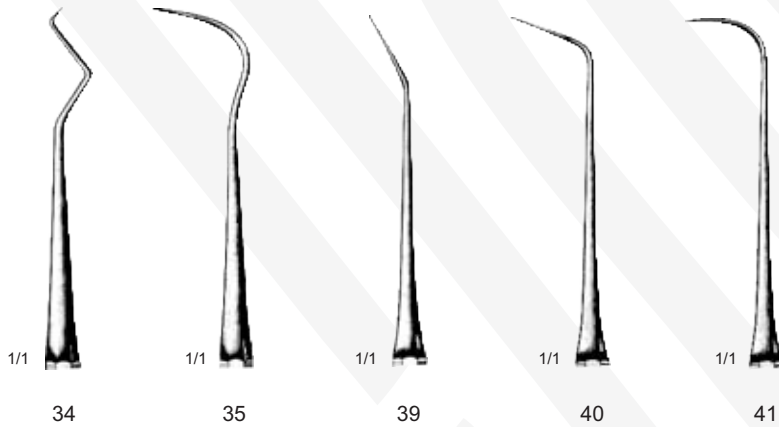

White

A	SKL-015- 34	SKL-015- 35	SKL-015- 39	SKL-015- 40	SKL-015- 41
B	SKL-016-34	SKL-016-35	SKL-016-39	SKL-016-40	SKL-016-41
C	SKL-017-34	SKL-017-35	SKL-017-39	SKL-017-40	SKL-017-41

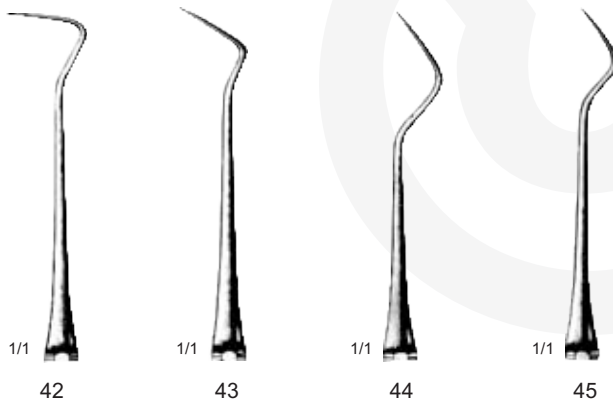

White

A	SKL-015- 42	SKL-015- 43	SKL-015- 44	SKL-015- 45
B	SKL-016-42	SKL-016-43	SKL-016-44	SKL-016-45
C	SKL-017-42	SKL-017-43	SKL-017-44	SKL-017-45



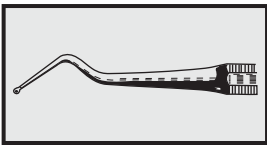

A	SKL-018-02	SKL-018-03	SKL-018-05	SKL-018-06
B	SKL-019-02	SKL-019-03	SKL-019-05	SKL-019-06
C	SKL-020-02	SKL-020-03	SKL-020-05	SKL-020-06

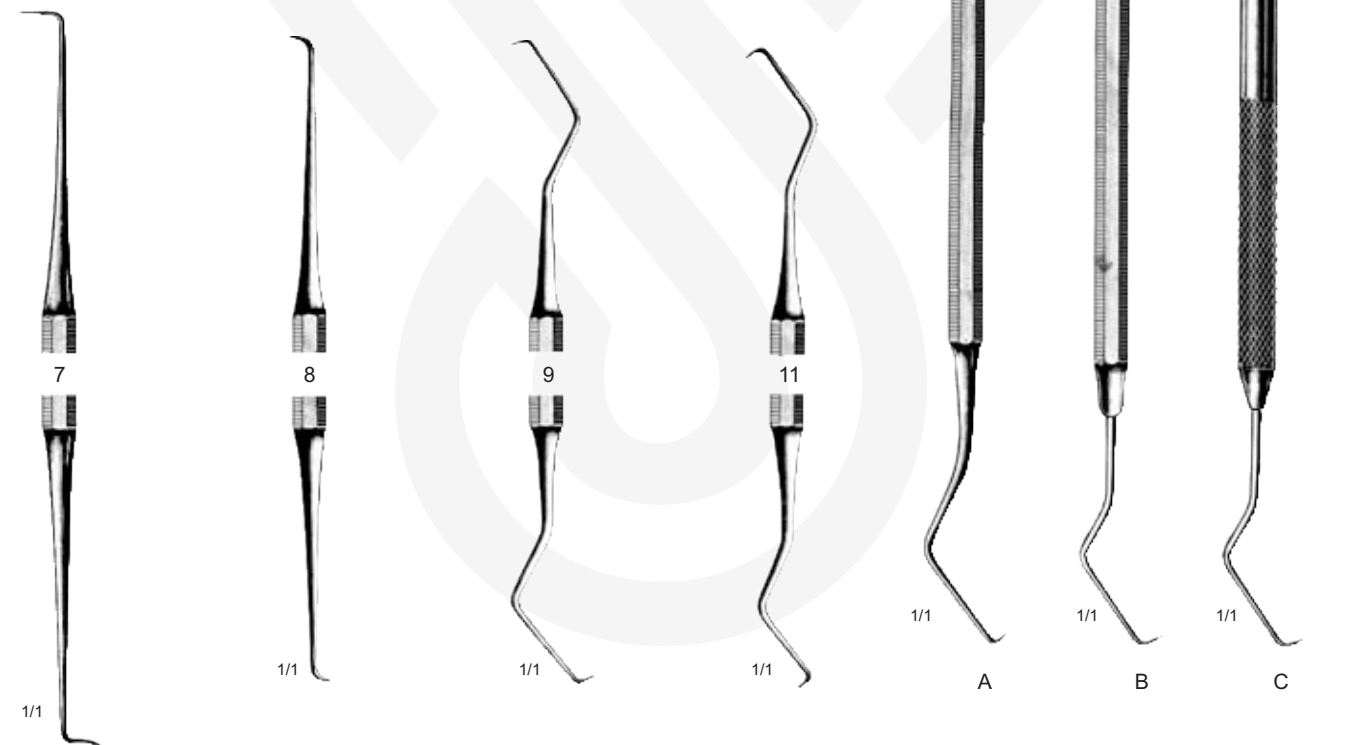

A	SKL-018-07	SKL-018-08	SKL-018-09	SKL-018-11
B	SKL-019-07	SKL-019-08	SKL-019-09	SKL-019-11
C	SKL-020-07	SKL-020-08	SKL-020-09	SKL-020-11

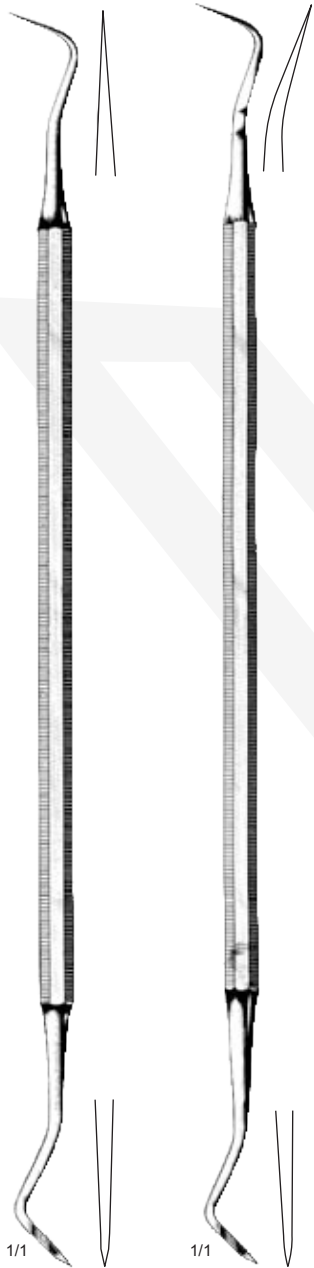
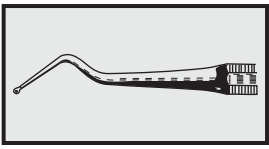

Lange
SKL-021-01

Lange
SKL-021-02



Weston
SKL-023-01



Weston
SKL-025-01



SKL-027-01



SKL-027-02



SKL-027-03

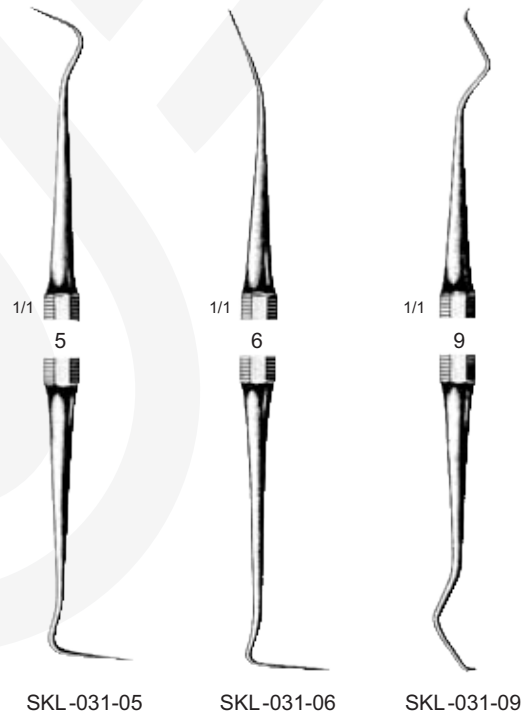
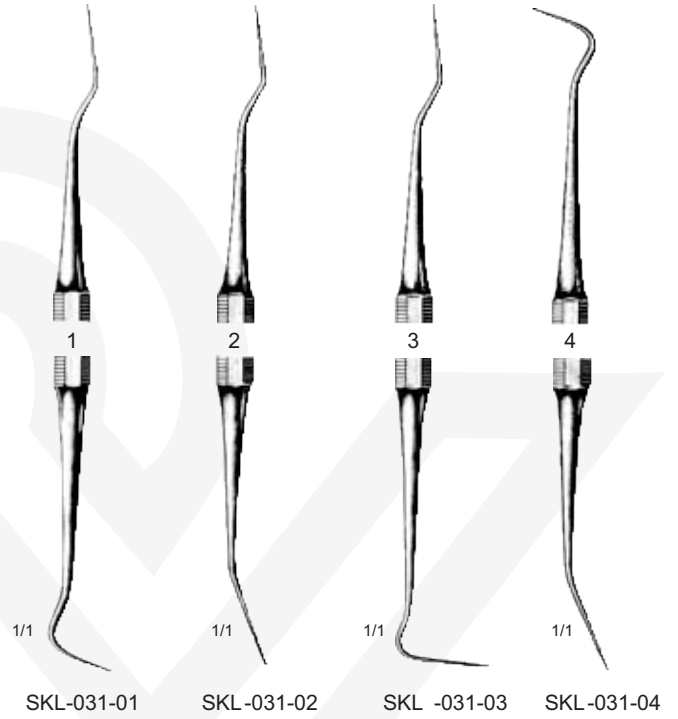
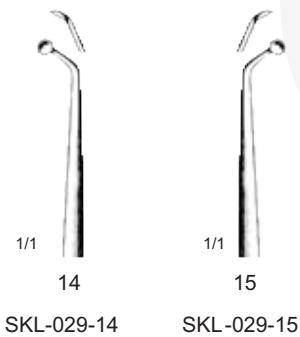
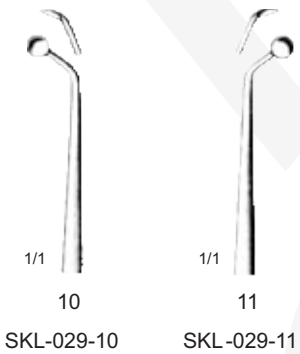
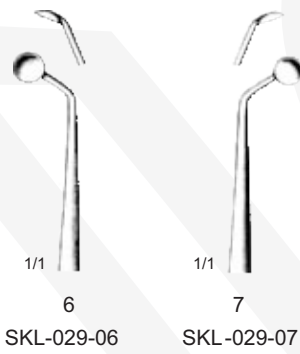
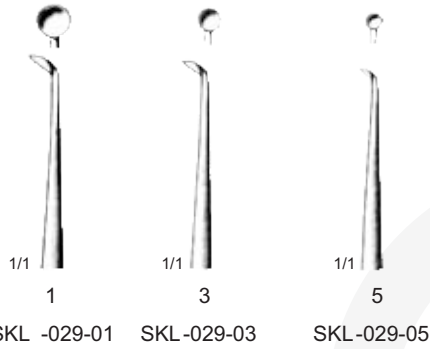
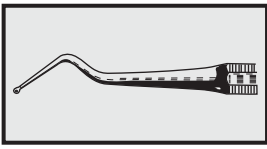

1/1
Witzel
Dentine Spoon

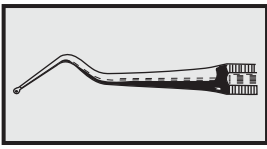

1/1	5	1/1	6	1/1	7	1/1	8	1/1	9	1/1	10
A	SKL-033-05	SKL-033-06	SKL-033-07	SKL-033-08	SKL-033-09	SKL-033-10					
	5/6		7/8		9/10						
E	SKL-035-05		SKL-035-07		SKL-035-09						

1/1	11	1/1	12	1/1	13	1/1	14	1/1	15	1/1	16
A	SKL-033-11	SKL-033-12	SKL-033-13	SKL-033-14	SKL-033-15	SKL-033-16					
	11/12		13/14		15/16						
E	SKL-035-11		SKL-035-13		SKL-035-15						

1/1	17	1/1	18	1/1	19	1/1	20	1/1	21	1/1	22
A	SKL-033-17	SKL-033-18	SKL-033-19	SKL-033-20	SKL-033-21	SKL-033-22					
	17/18		19/20		21/22						
E	SKL-035-17		SKL-035-19		SKL-035-21						

Darby-Perry

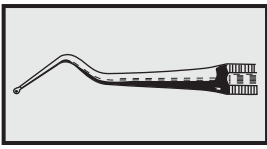

	3	4	7	8	9	10
A	SKL-037-03	SKL-037-04	SKL-037-07	SKL-037-08	SKL-037-09	SKL-037-10
	3/4		7/8		9/8	
E	SKL-039-03		SKL-039-07		SKL-039-09	

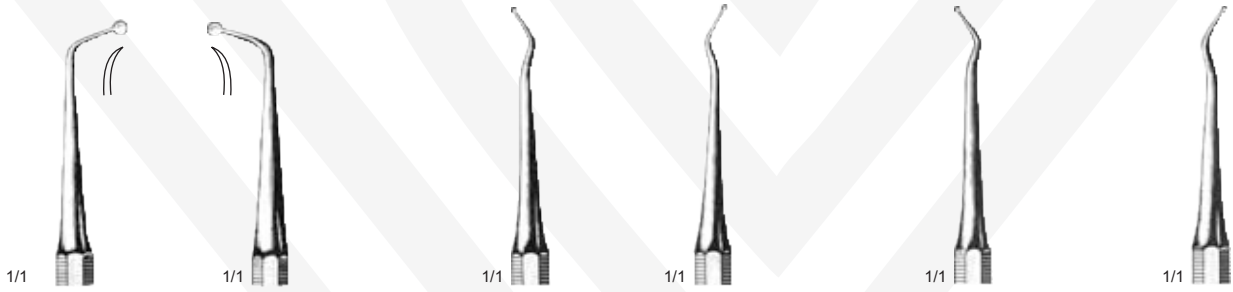

	11	12	13	14	15	16
A	SKL-037-11	SKL-037-12	SKL-037-13	SKL-037-14	SKL-037-15	SKL-037-16
	11/12		13/14		15/16	
E	SKL-039-11		SKL-039-13		SKL-039-15	

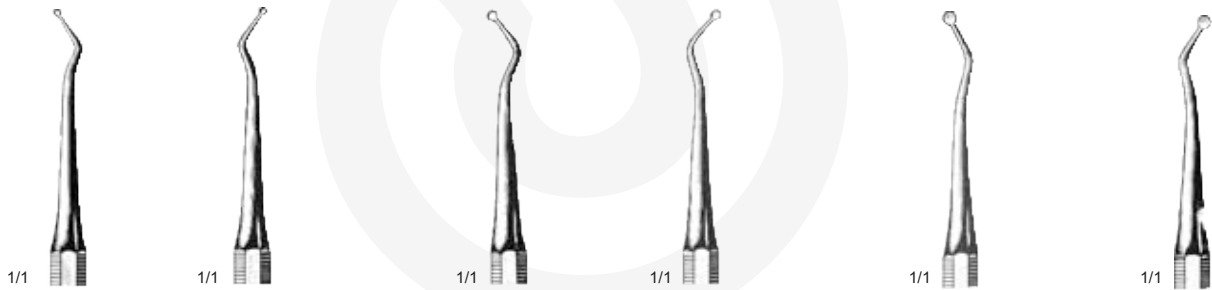

	17	18	19	20	21	22
A	SKL-037-17	SKL-037-18	SKL-037-19	SKL-037-20	SKL-037-21	SKL-037-22
	17/18		19/20		21/22	
E	SKL-039-17		SKL-039-19		SKL-039-21	

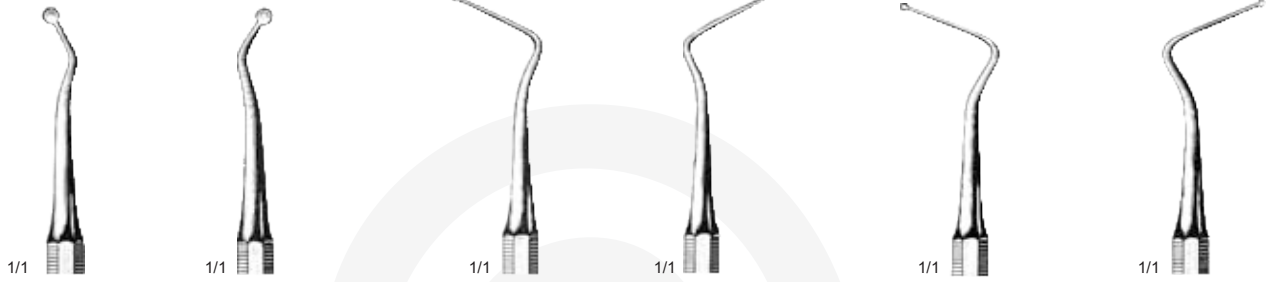
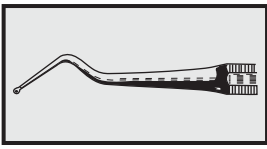

	23	24	25	26	27	28
A	SKL-037-23 23/24	SKL-037-24	SKL-037-25 25/26	SKL-037-26	SKL-037-21 27/28	SKL-037-28
E	SKL-039-23		SKL-039-25		SKL-039-27	

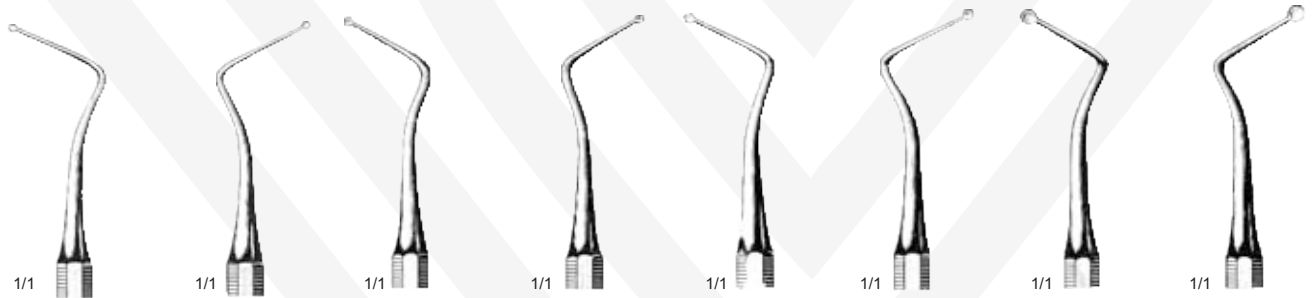

	29	30	31	32	33	34	35	36
A	SKL-037-29 29/30	SKL-037-30	SKL-037-31 31/32	SKL-037-32	SKL-037-33 33/34	SKL-037-34	SKL-037-35 35/36	SKL-037-36
E	SKL-039-29		SKL-039-31		SKL-039-33		SKL-039-35	

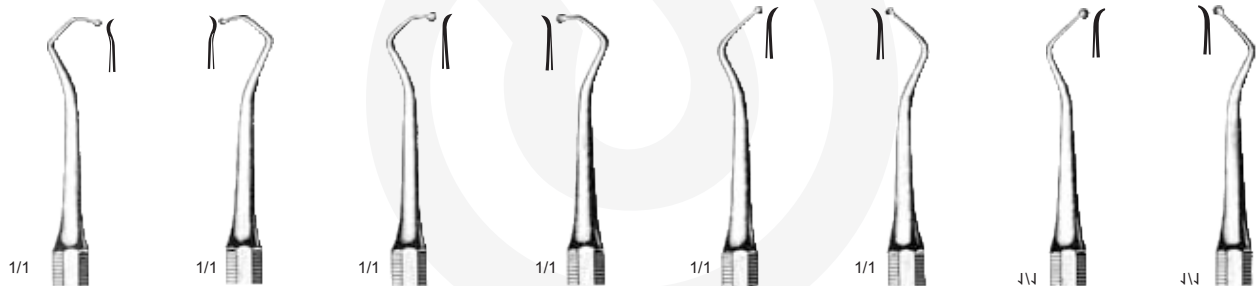

	4 Gillet	5 Gillet	6 Gillet	7 Gillet	12 Gillet	13 Gillet	14 Gillet	15 Gillet
A	SKL-041-04 4/5	SKL-041-05	SKL-041-06 6/7	SKL-041-07	SKL-041-12 12/13	SKL-041-13	SKL-041-14 14/15	SKL-041-15
E	SKL-043-04		SKL-043-06		SKL-043-12		SKL-043-14	



cm	in	Straight	Curved	Straight	Curved	Straight	Curved
9	3½			SKL-083-09	SKL-085-09		
10	4			SKL-083-10	SKL-085-10		
11	4½	SKL-079-11	SKL-081-11	SKL-083-11	SKL-085-11	SKL-087-11	SKL-089-11
11.5	4½						

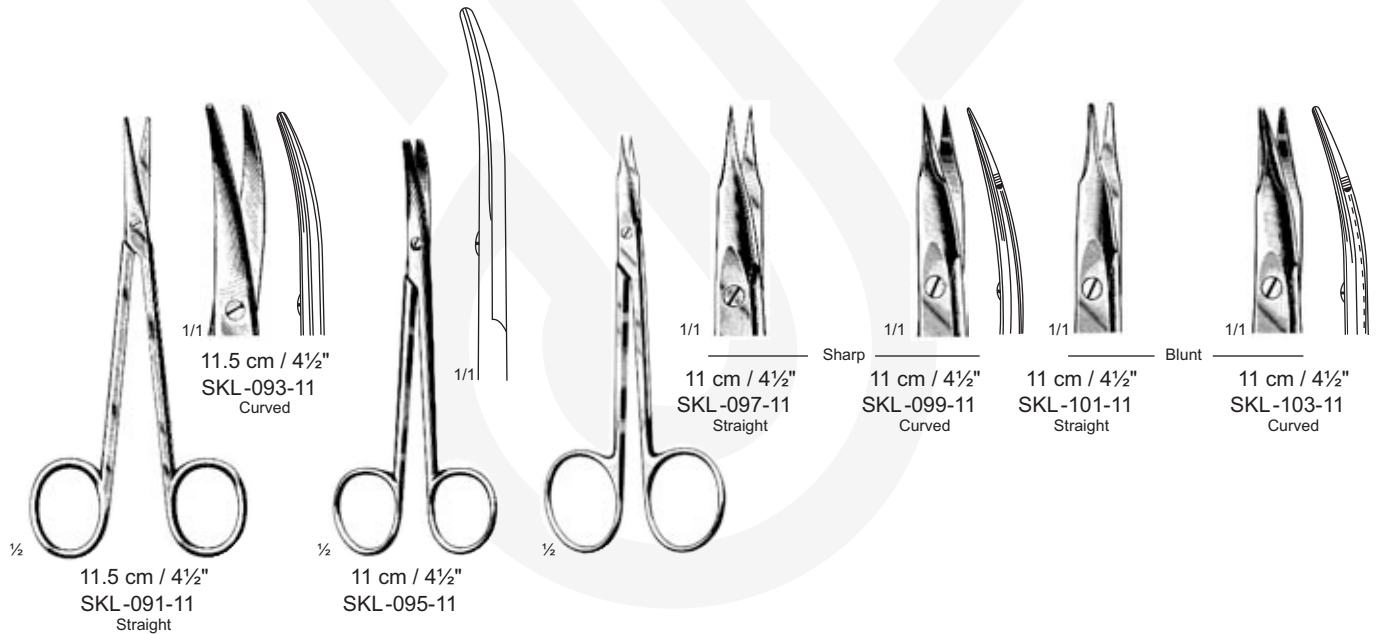

SKL-083-09 SKL-089-11 Iris Scissors

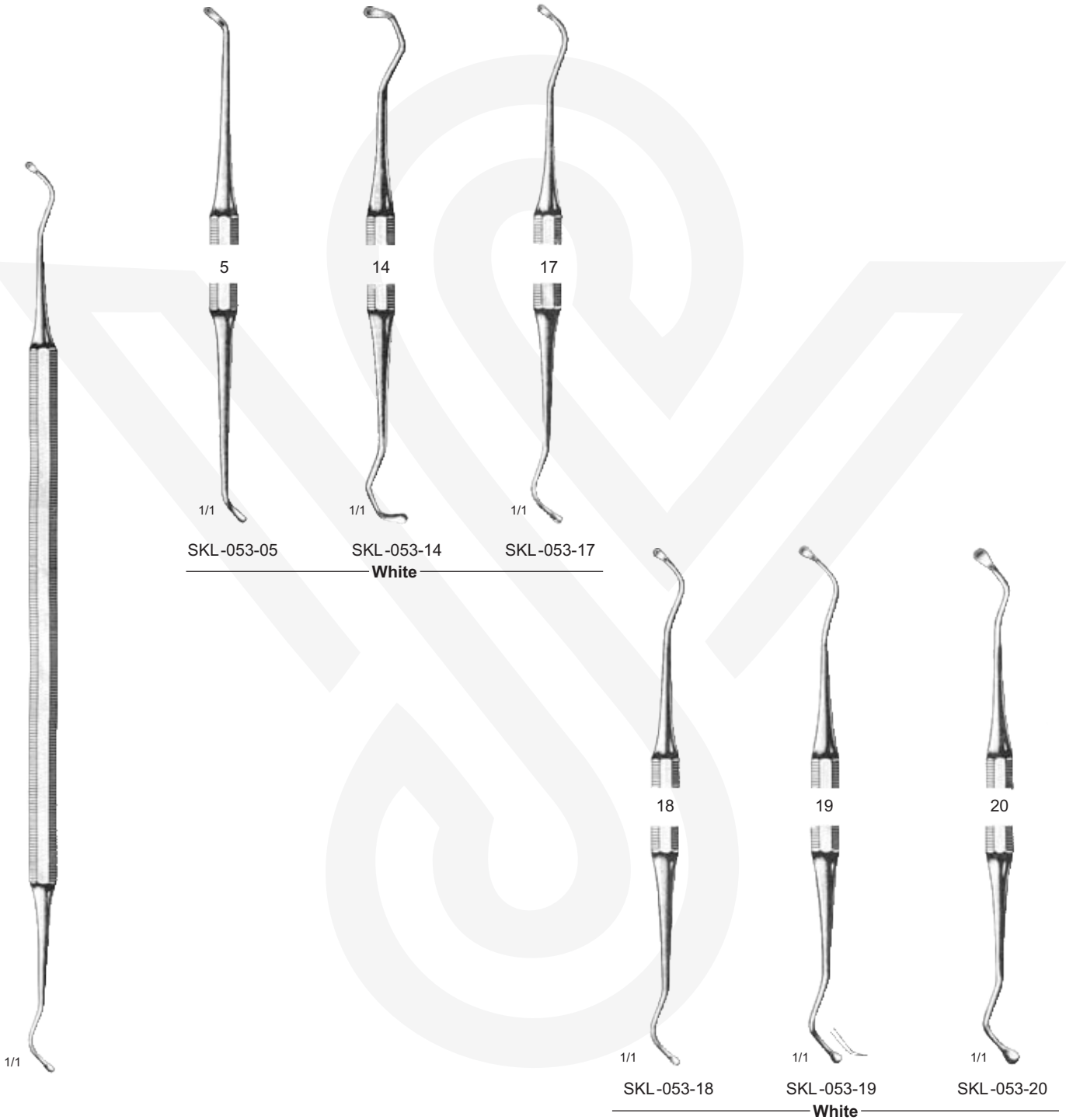
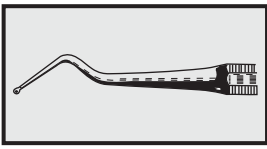

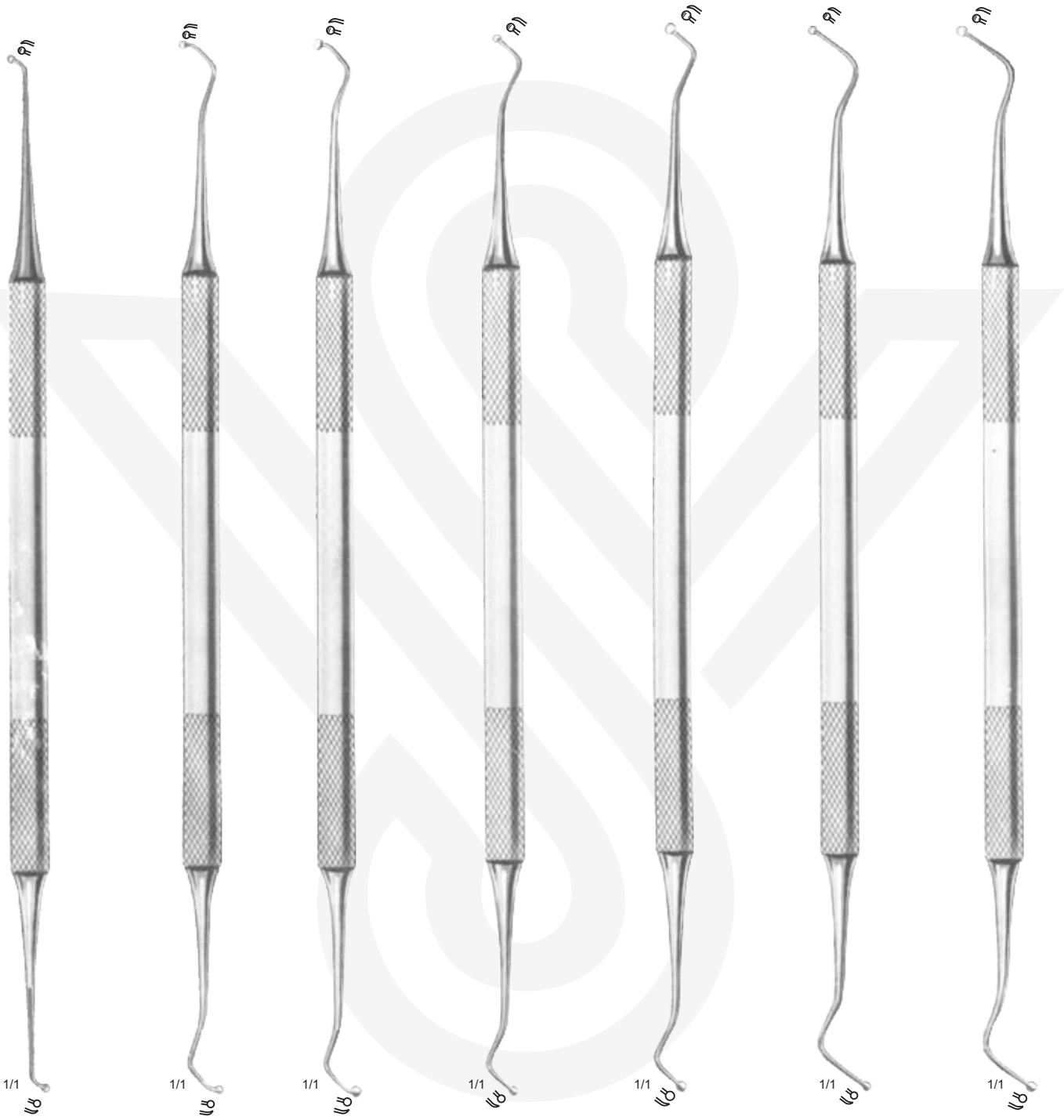
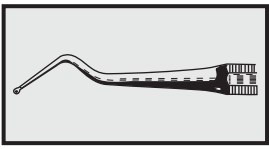

SKL-055-05

SKL-055-13

SKL-055-14

SKL-055-17

SKL-055-18

SKL-055-31

SKL-055-33

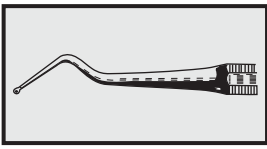

1/1

Black

1/1	1/1	1/1	1/1	1/1	1/1	1/1
3	9	14	17	20	28	32
SKL-057-03	SKL-057-09	SKL-057-14	SKL-057-17	SKL-057-20	SKL-057-28	SKL-057-32
A 10	10	12	6	12	8	12
B 4	4	5	2	5	3	5
C 6	12	18	18	23	6	12

1/1	1/1	1/1	1/1	1/1	1/1	1/1
38	41	51	52	53	54	57
SKL-057-38	SKL-057-41	SKL-057-51	SKL-057-52	SKL-057-53	SKL-057-54	SKL-057-57
A 12	6	15	15	10	10	15
B 5	2	8	8	6	6	8
C 18	18	12	12	12	12	6
		L	R	L	R	L

1/1	1/1	1/1	1/1	1/1	1/1	1/1
58	61	62	63	64	65	66
SKL-057-58	SKL-057-61	SKL-057-62	SKL-057-63	SKL-057-64	SKL-057-65	SKL-057-66
A 15	20	20	15	15	10	10
B 8	9	9	8	8	6	6
C 6	12	12	12	12	12	12
R	L	R	L	R	L	R

A) Width of Blade in 1/10 mm
 B) Length of the blade in mm
 C) Angle of the blade to its handle

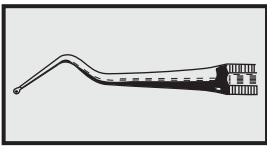





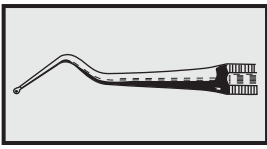







1/1							
	69	70	73	74	75	76	77
	SKL-059-69	SKL-059-70	SKL-059-73	SKL-059-74	SKL-059-75	SKL-059-76	SKL-059-77
	A 15	15	20	20	20	20	15
	B 8	8	9	9	9	9	8
	C 23	23	12	12	12	12	12
	L	R	L	R	L	R	L
	78	81	82	83	84	85	
	SKL-059-78	SKL-059-81	SKL-059-82	SKL-059-83	SKL-059-84	SKL-059-85	
A 15	20	15	10	20	15		
B 8	9	8	6				
C 12	6	6	6				
R							
1/1							
	86	87	90	93	95	98	99
	SKL-059-86	SKL-059-87	SKL-059-90	SKL-059-93	SKL-059-95	SKL-059-98	SKL-059-99
	A 10	5	15	15	12	8	12
	B 8	3	1 1/2	8	6	8	8
	C 28	12	12	12	23	12	12

A) Width of Blade in 1/10 mm
 B) Length of the blade in mm
 C) Angle of the blade to its handle



49	51	53	57	61	63
SKL-061-49	SKL-061-51	SKL-061-53	SKL-061-57	SKL-061-61	SKL-061-63
20	15	10	15	20	15
9	8	6	8	9	8
12	12	12	6	12	12
L	L	L	L	L	L

49	51	53	57	61	63
					
50	52	54	58	62	64
					
50	52	54	58	62	64
SKL-061-50	SKL-061-52	SKL-061-54	SKL-061-58	SKL-061-62	SKL-061-64
20	15	10	15	20	15
9	8	6	8	9	8
12	12	12	6	12	12
L	L	L	L	L	L

A) Width of Blade in 1/10 mm
 B) Length of the blade in mm
 C) Angle of the blade to its handle

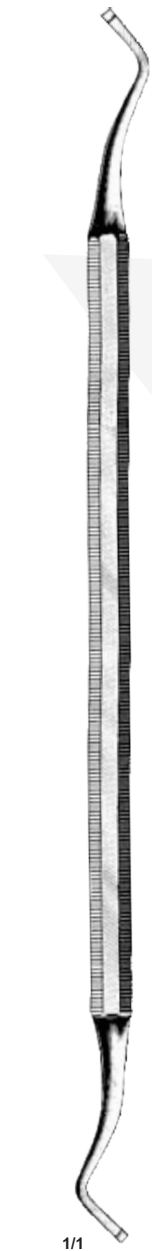
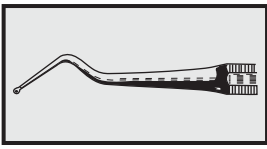

65	69	73	75	77	79
SKL-063-65	SKL-063-69	SKL-063-73	SKL-063-75	SKL-063-77	SKL-063-79
10	15	20	20	15	15
6	8	9	9	8	8
12	23	12	12	12	12
R	R	R	R	R	R

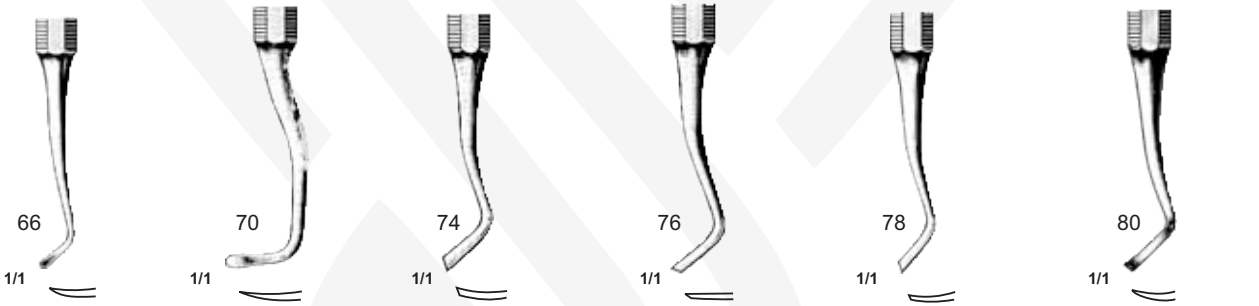
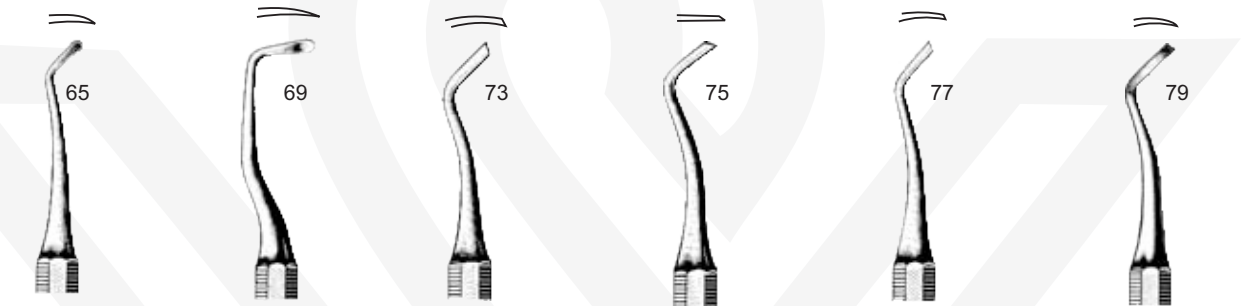

66	70	74	76	78	80
SKL-063-66	SKL-063-70	SKL-063-74	SKL-063-76	SKL-063-78	SKL-063-80
10	15	20	20	15	15
6	8	9	9	8	8
12	23	12	12	12	12
L	L	L	L	L	L

A) Width of Blade in 1/10 mm
 B) Length of the blade in mm
 C) Angle of the blade to its handle

1/1

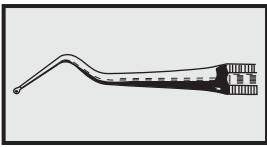

SKL-071-01 SKL-071-03 Nerve Canal Pluggers
SKL-073-01 SKL-073-03 Abscess and Fistula Probes

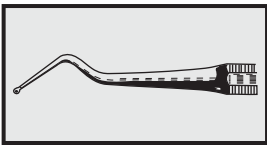

1/1
Abbott
SKL-085-01



1/1
SKL-087-01



SKL-087-02



SKL-087-03



SKL-087-04



SKL-087-05



SKL-087-07



SKL-087-08



SKL-087-09

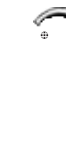

SKL-087-10



SKL-087-11



SKL-087-12



1/1
Marshall
SKL-089-01



1/1
1
SKL-091-01



5
SKL-091-05



8
SKL-091-08



9
SKL-091-09



1/1
Gold Plugger

SKL-085-01	Automatic mallet	
SKL-089-01	Pellet Placer	
SKL-091-01	SKL-091-09	Gold pluggers



13 cm / 5"
SKL-105-13



Spencer
9 cm / 3½"
SKL-107-09



Spencer
13 cm / 5"
SKL-109-13



Buck
14.5 cm / 5½"
SKL-111-14
18 cm / 7"
SKL-111-18



12 cm / 4¾"
SKL-113-12



Littauer
14 cm / 5½"
SKL-115-14



Heath
15 cm / 6"
SKL-117-15



Shoemaker-Loth
13 cm / 5"
SKL-119-13



Eiselsberg
12 cm / 4¾"
SKL-121-12

SKL-105-13 SKL-121-12 Ligature Scissors

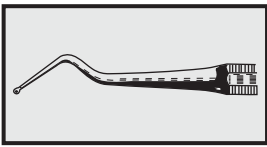

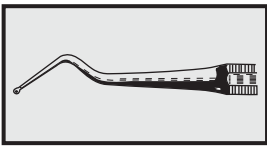

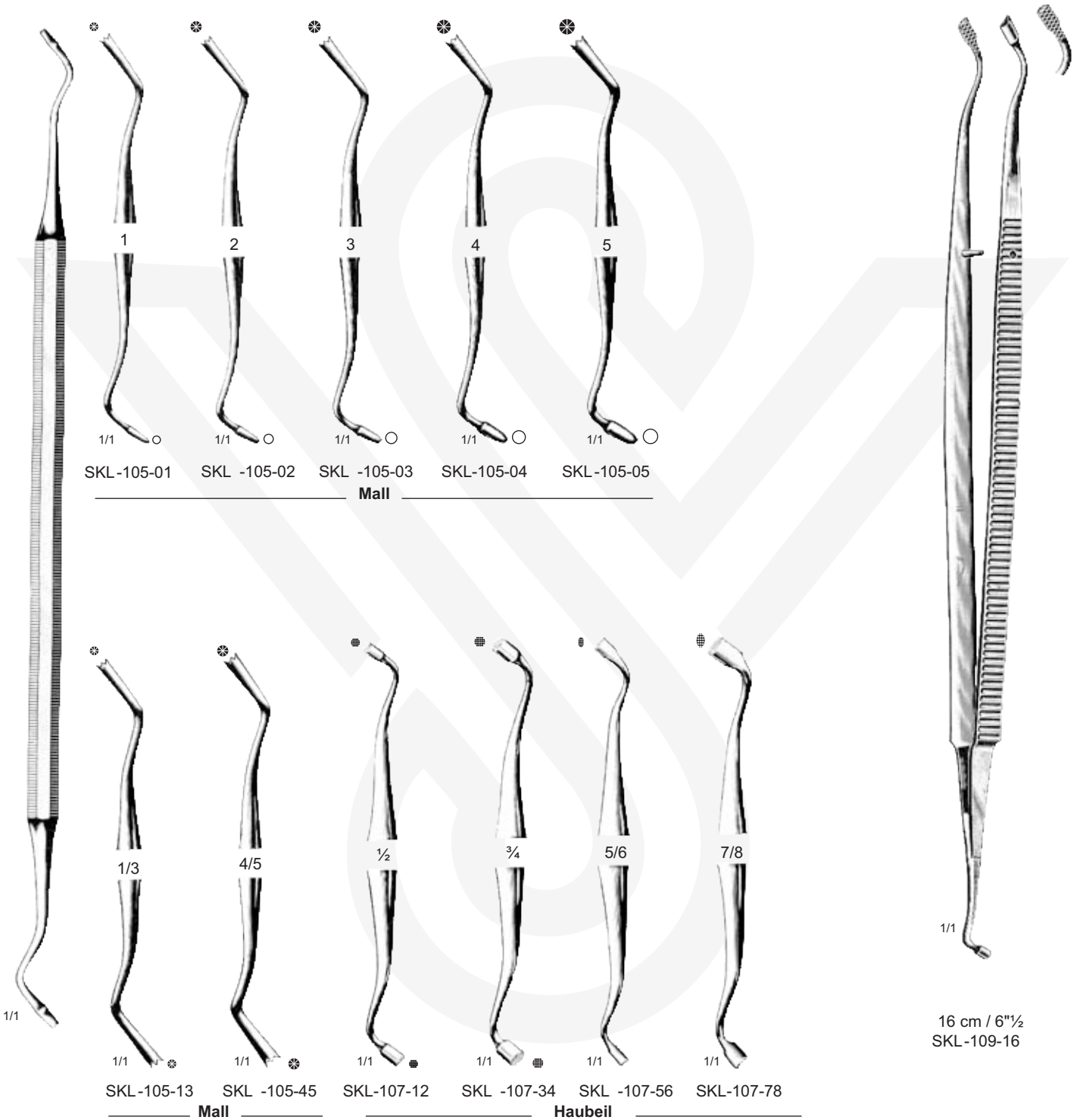
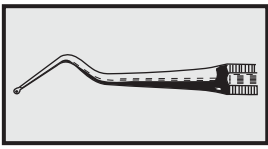

SKL-107-78	SKL-105-01	Amalgam Pluggers
	SKL-109-02	Amalgam Spetula
	SKL-111-16	Amalgam Plugging Pliers

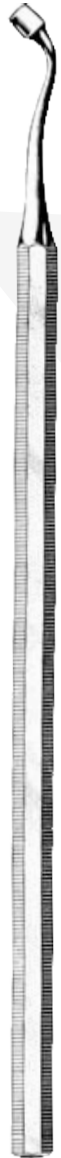
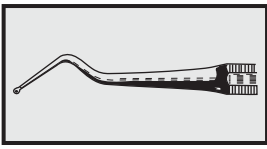

1/1	1/1	1/1	1/1	1/1	1/1	1/1	1/1
31	39	40	42	45	47	56	
Weston			Lewis		Foster-Flagg	Foster-Flagg	
SKL-113-31	SKL-115-39	SKL-115-40	SKL-115-42	SKL-115-45	SKL-117-47	SKL-117-56	
1/1	1/1	1/1	1/1	1/1	1/1	1/1	1/1
62	78	00	0	1	2	3	
Woodson	Woodson			Black			
SKL-119-62	SKL-121-78	SKL-123-00	SKL-123-10	SKL-123-01	SKL-123-02	SKL-123-03	
1/1	1/1	1/1	1/1	1/1	1/1	1/1	1/1
4	5	6	7	1	4		
SKL-123-04	SKL-123-05	SKL-123-06	SKL-123-07	Arrington	Arrington		
				SKL-125-01	SKL-125-04		
1/1	1/1	1/1	1/1	1/1	1/1	1/1	1/1
5	10	11	19	20	24		
SKL-125-05	SKL-125-10	SKL-125-11	SKL-125-19	SKL-125-20	SKL-125-24		
			Arrington				

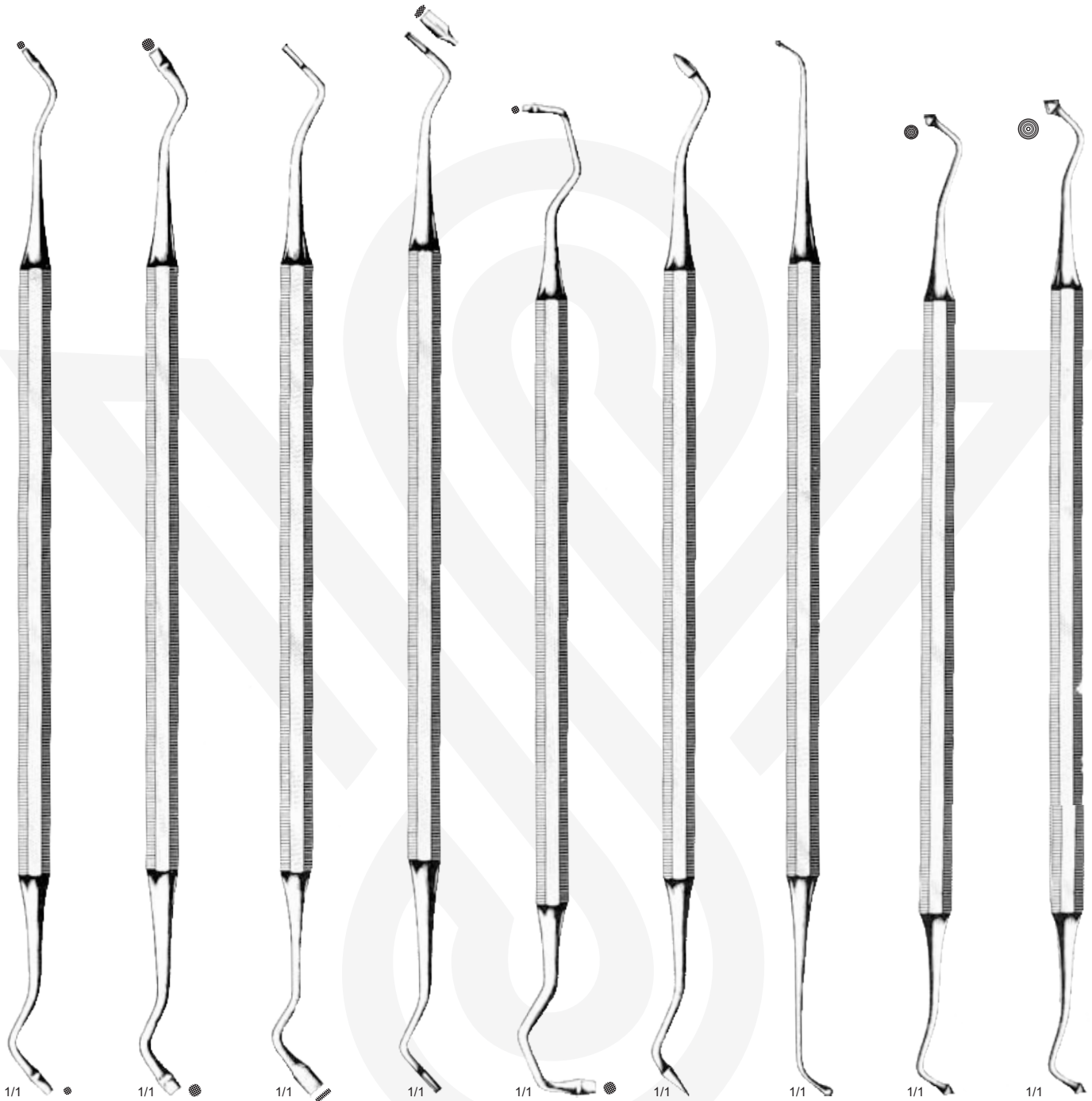
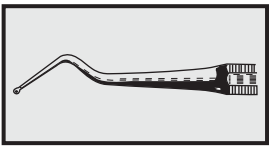

1/1

1/1

1/1

1/1

1/1

1/1

1/1

1/1

1/1

SKL -126-01

SKL -126-02

SKL -126-03

Hollenback
SKL -126-04

SKL -126-05

SKL -126-06

SKL -126-07

Mod. USA
SKL -127-01

Mod. USA
SKL -127-02

SKL-126-01 SKL-127-02 Amalgam Condensers, Double-ended

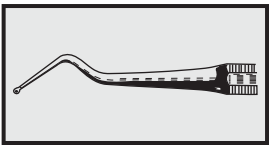

1/1
Pallas
SKL-128-01



1/1
SKL-129-01



1/1
Elliot
SKL-130-01

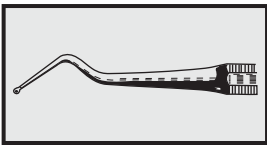

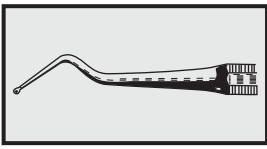

2/3

SKL-134-01
30 mm Ø



2/3

SKL-134-02
30 mm Ø



2/3

SKL-135-01



1/1

SKL-136-01



1/1

SKL-137-01



1/1

SKL-138-01

SKL-133-01	SKL-134-01	Finger Cups for pumice, amalgam, grinding paste
SKL-135-01		Mercury dispenser
SKL-136-01	SKL-138-01	Amalgam Guns

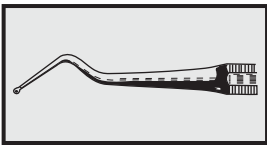

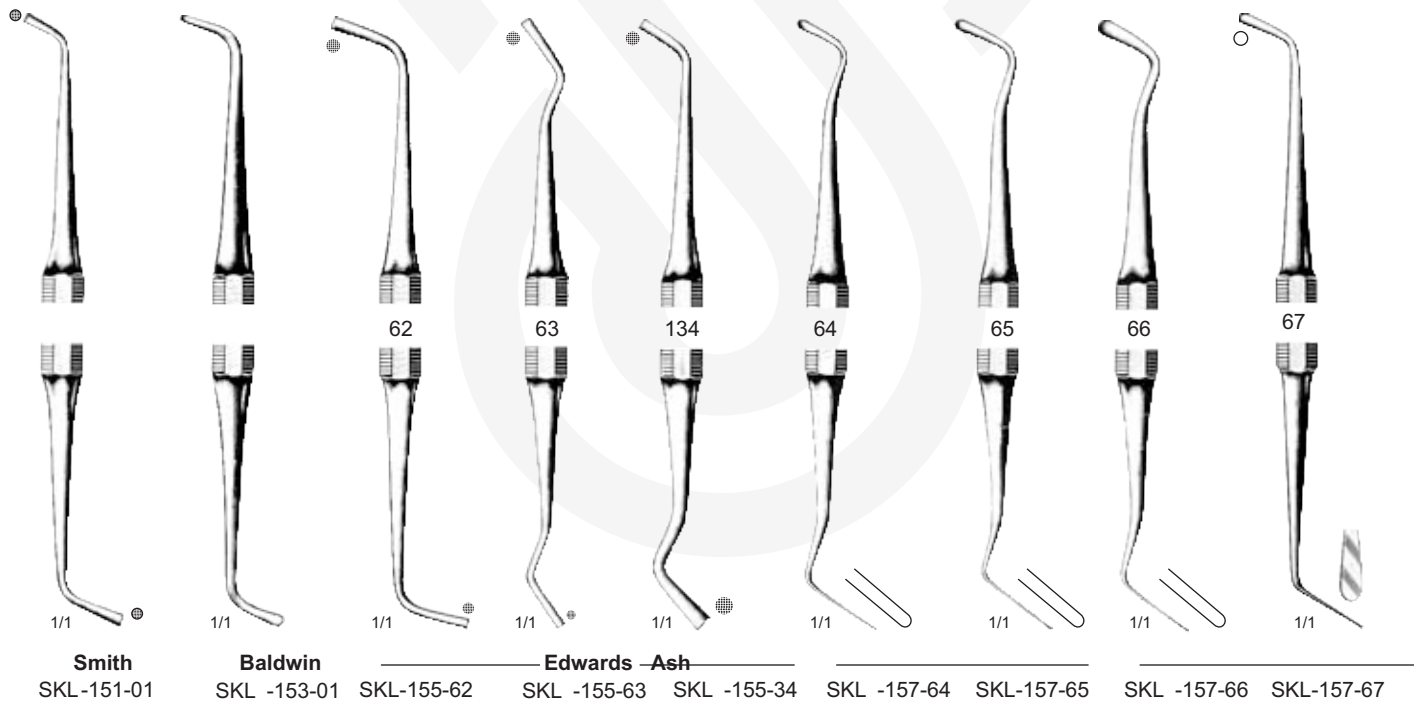
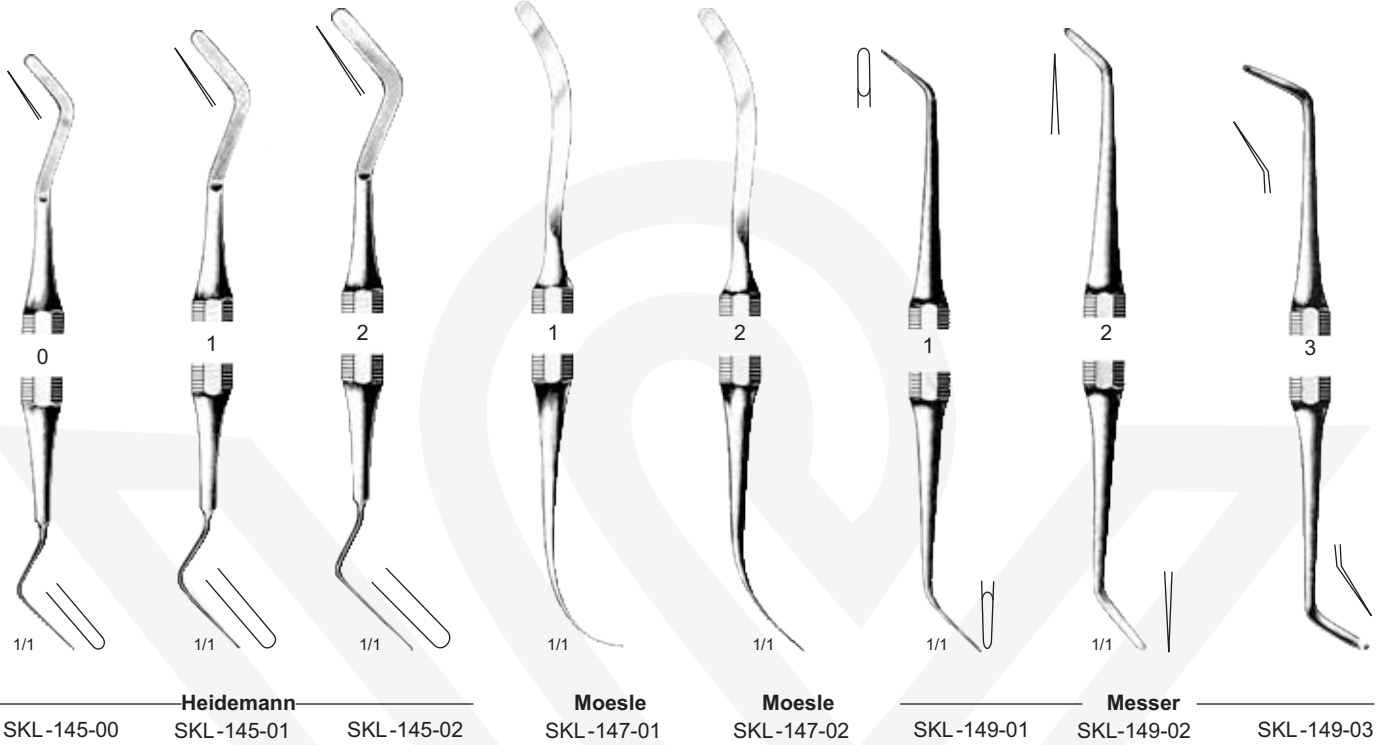
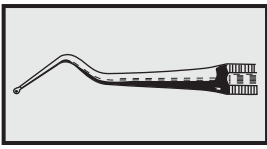

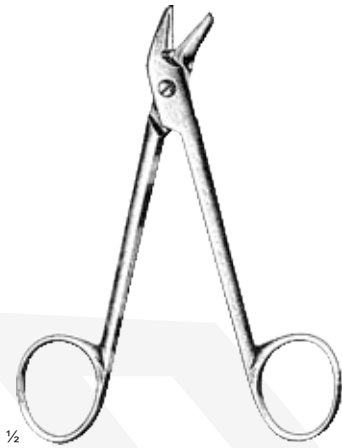

Universal
12 cm / 4¾"
SKL-123-12
Saw edge

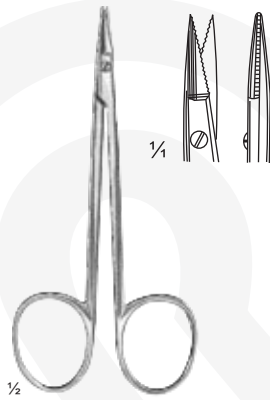

10 cm / 4"
SKL-125-10
Saw edge



SKL-127-10

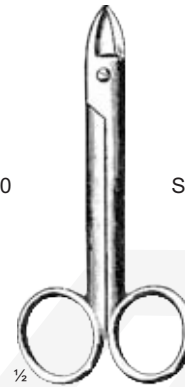

SKL-129-10



SKL-133-10

Beebee
10 cm / 4"
SKL-131-10
Sharp

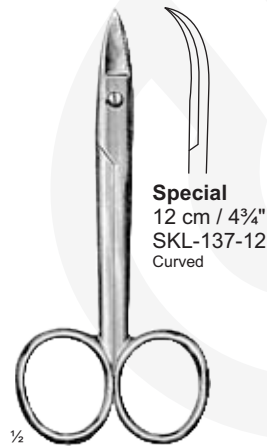

Special
12 cm / 4¾"
SKL-137-12
Curved

Special
12 cm / 4¾"
SKL-135-12
Saw edge



18 cm / 7"
SKL-139-18
Straight



18 cm / 7"
SKL-141-18
Crurved

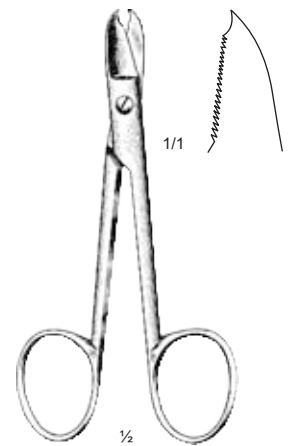

12 cm / 4¾"
SKL-143-12
Saw edge

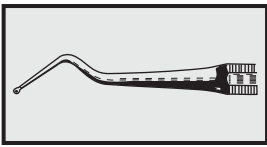

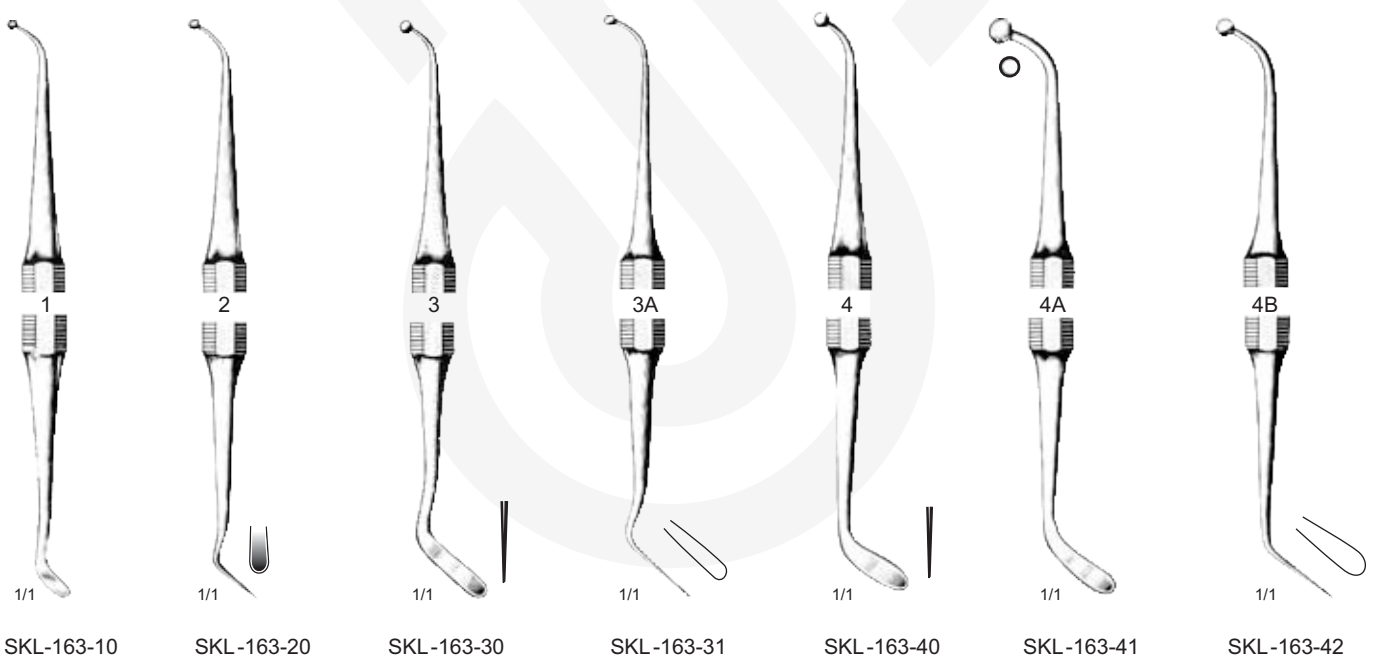
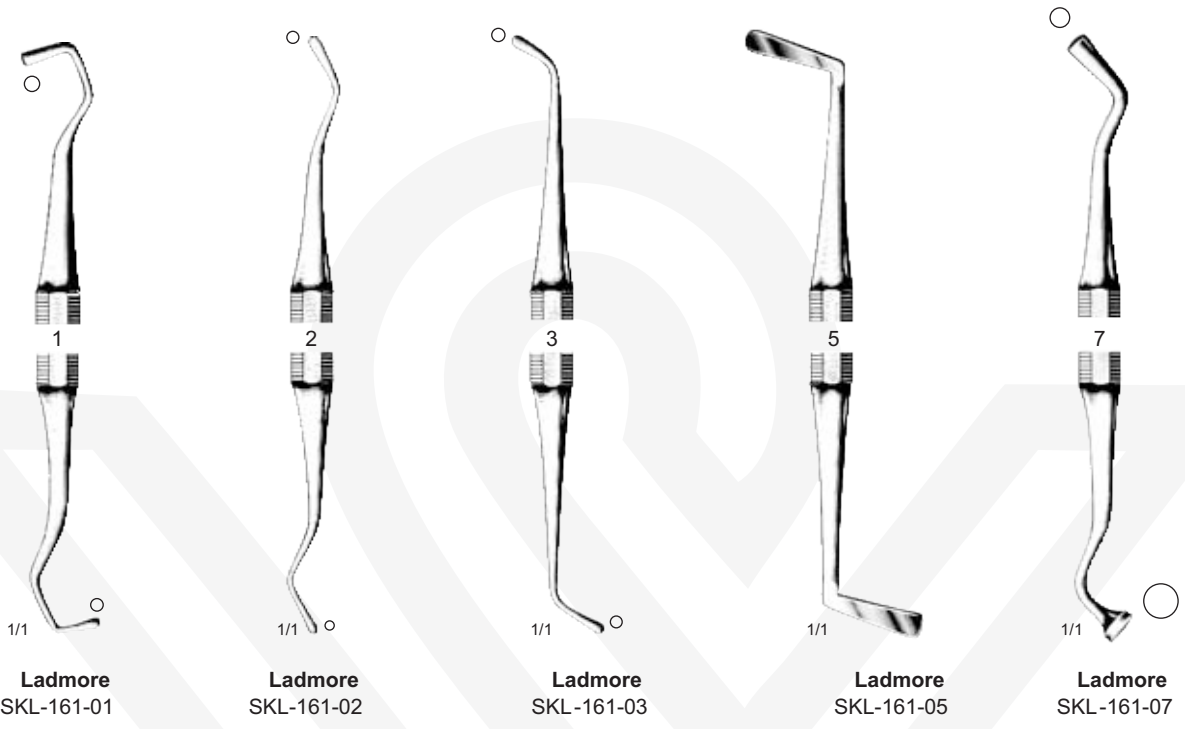
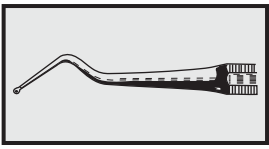

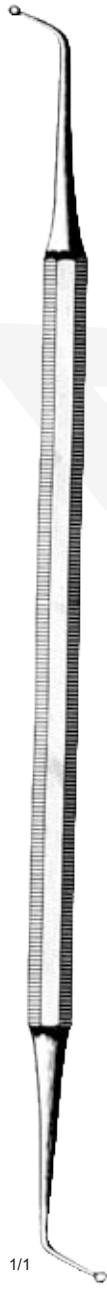
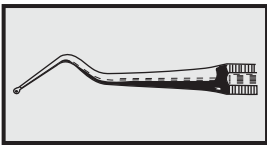

1/1

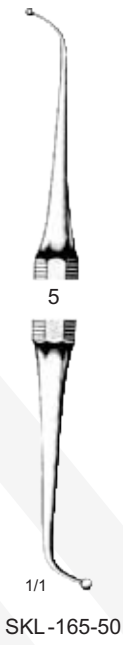

5

1/1

SKL-165-50



5A

1/1

SKL-165-51

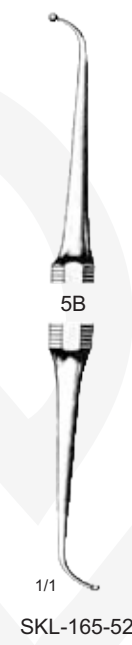

5B

1/1

SKL-165-52

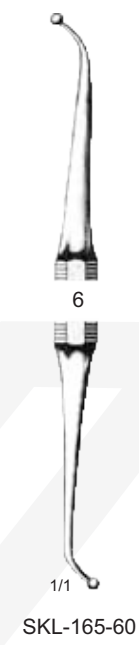

6

1/1

SKL-165-60



7

1/1

SKL-165-70



7A

1/1

SKL-165-71

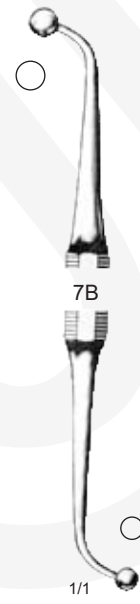

7B

1/1

SKL-165-72

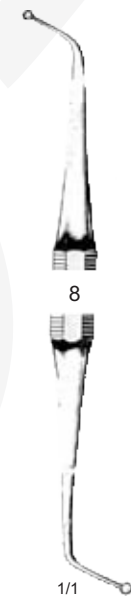

8

1/1

SKL-165-80



9

1/1

SKL-165-90

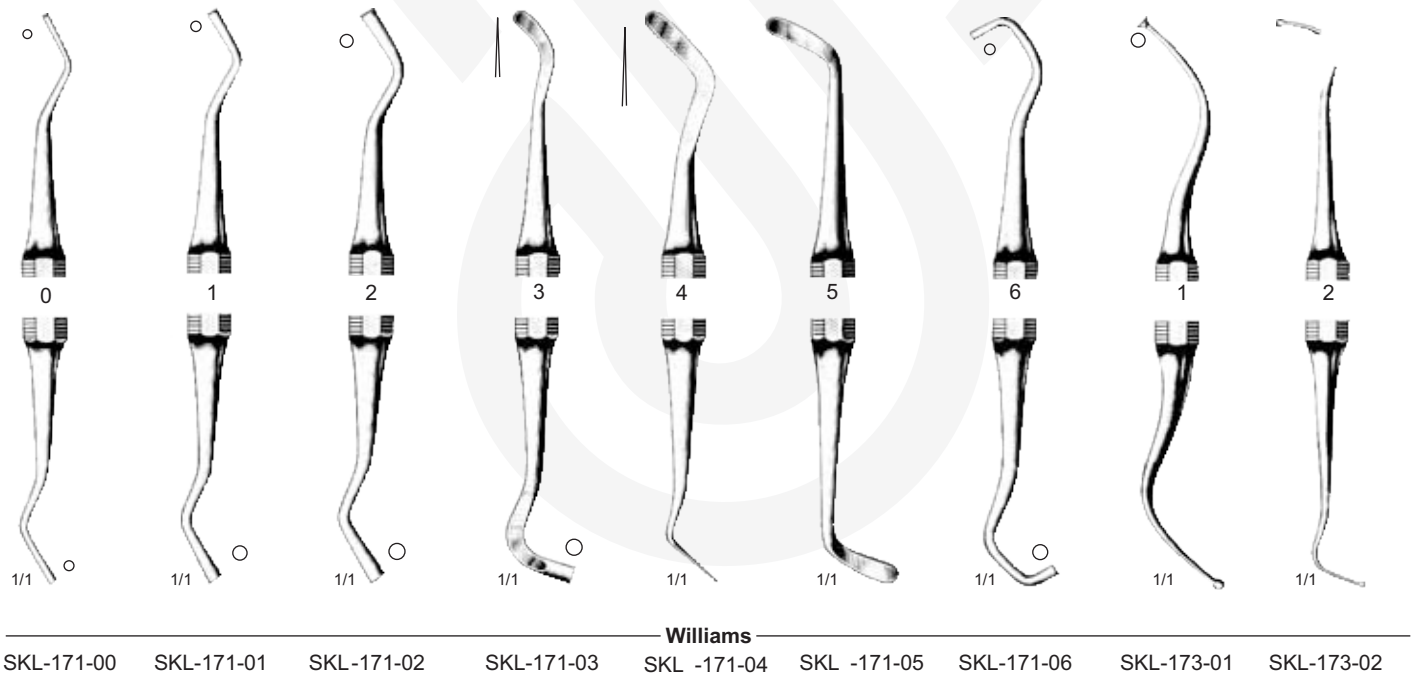
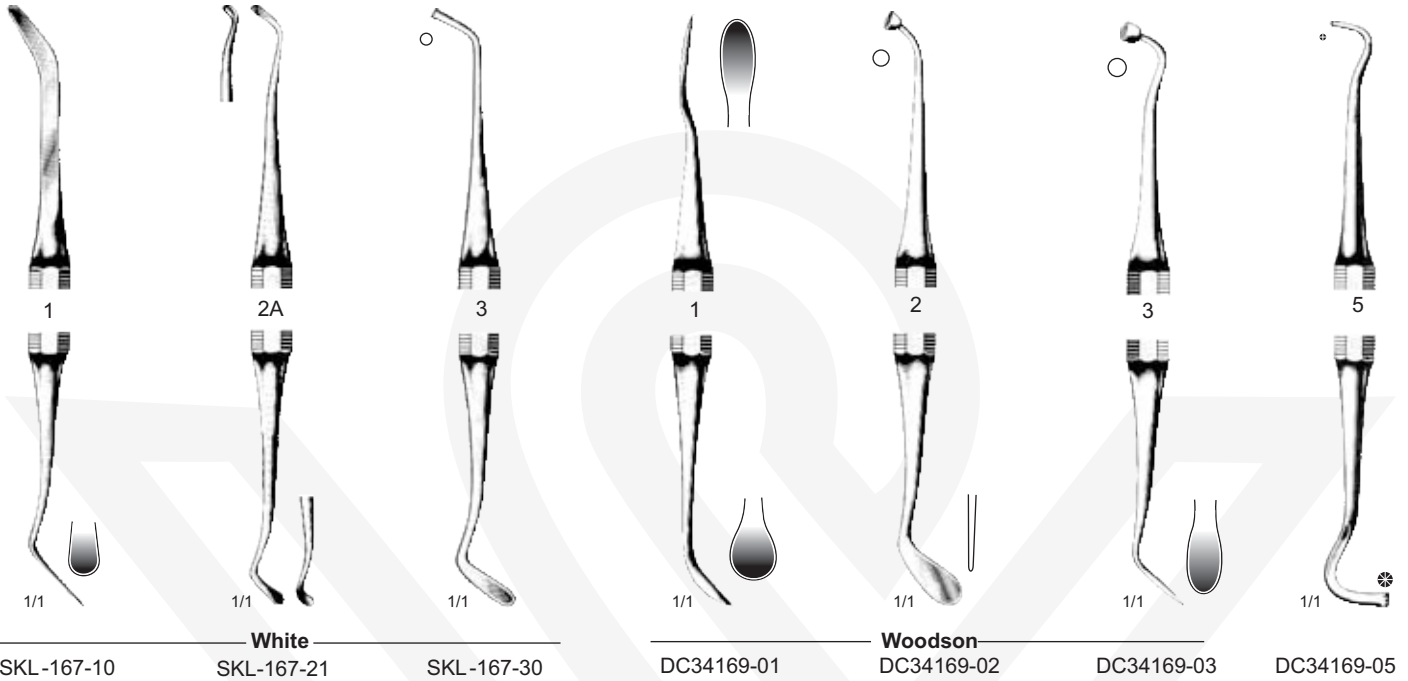
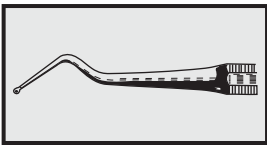

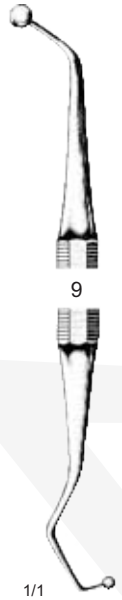
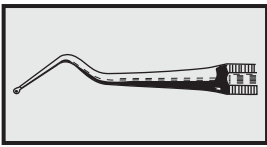

9

1/1

SKL-175-90



10

1/1

SKL-175-10



11

1/1

SKL-175-11



12

1/1

SKL-175-12

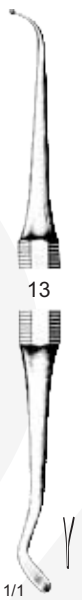

13

1/1

SKL-175-13

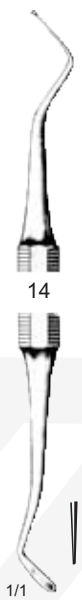

14

1/1

SKL-175-14



15

1/1

SKL-175-15



16

1/1

SKL-175-16



17

1/1

SKL-175-17

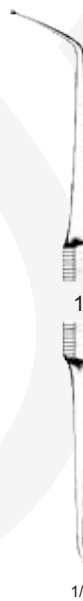

18

1/1

SKL-175-18



19

1/1

SKL-175-19

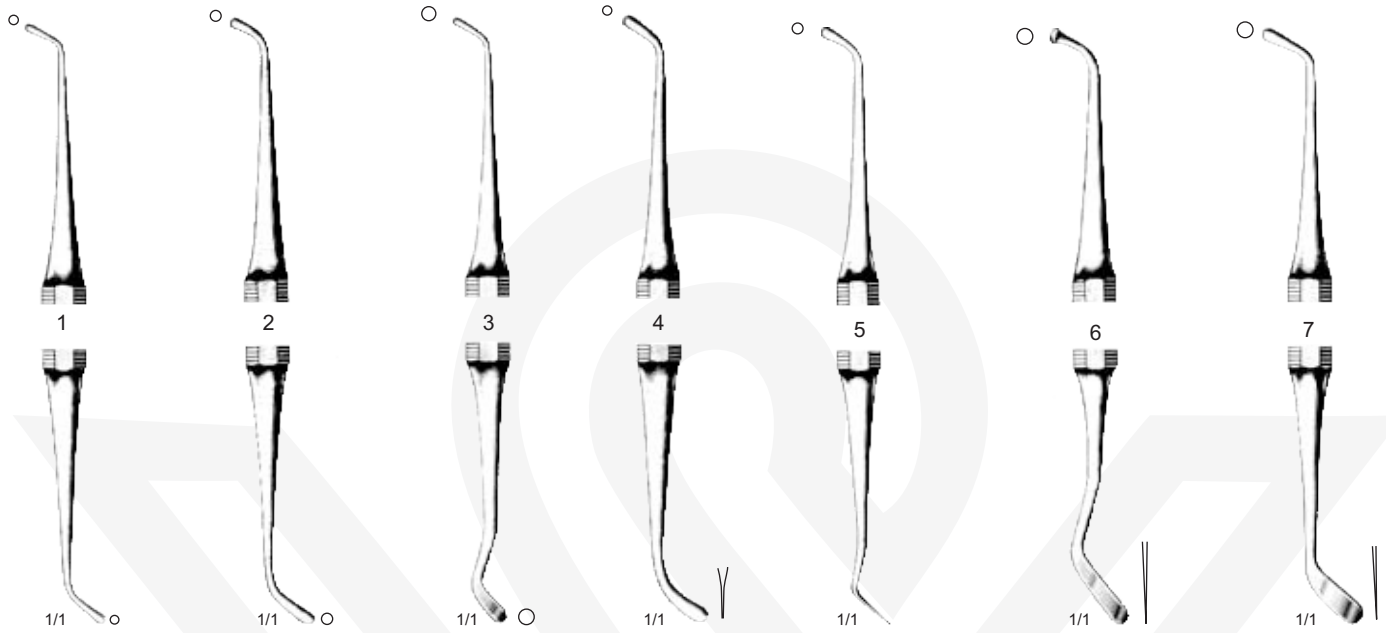
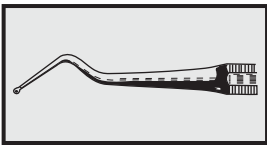

Ash

SKL-177-01

SKL-177-02

SKL-177-03

SKL-177-04

SKL-177-05

SKL-177-06

SKL-177-07

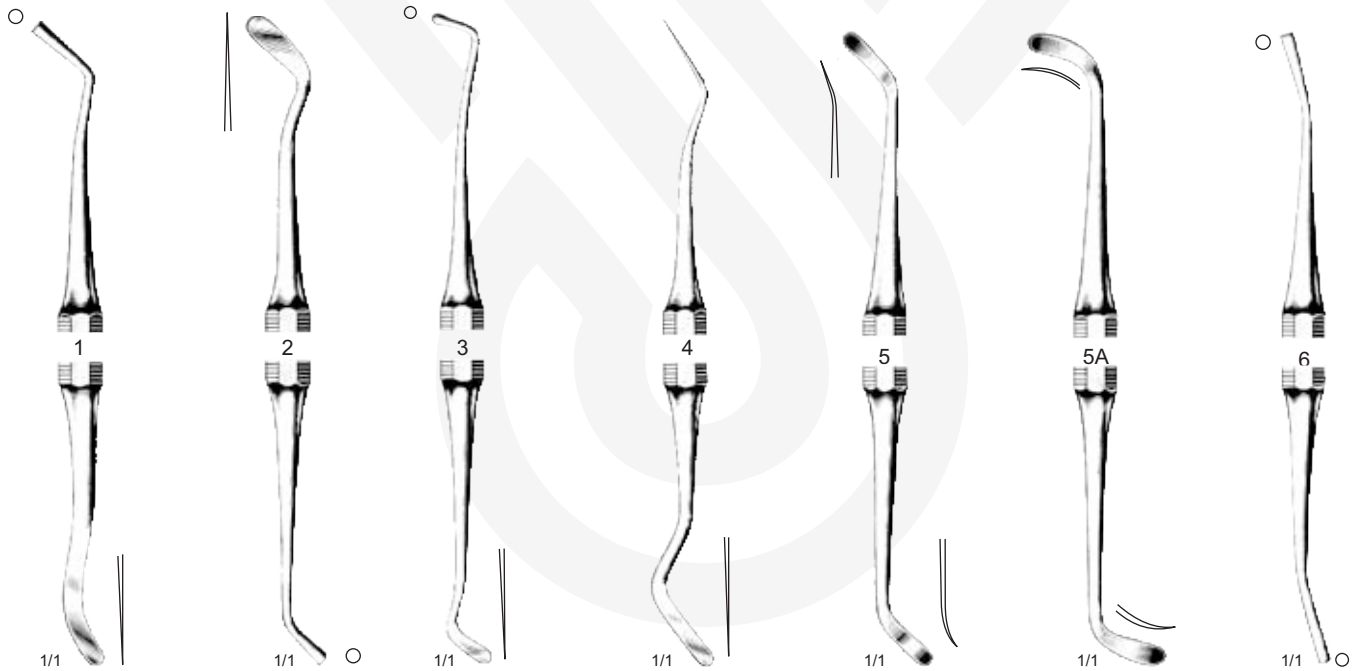

White

SKL-179-01

SKL-179-02

SKL-179-03

SKL-179-04

SKL-179-05

SKL-179-51

SKL-179-06

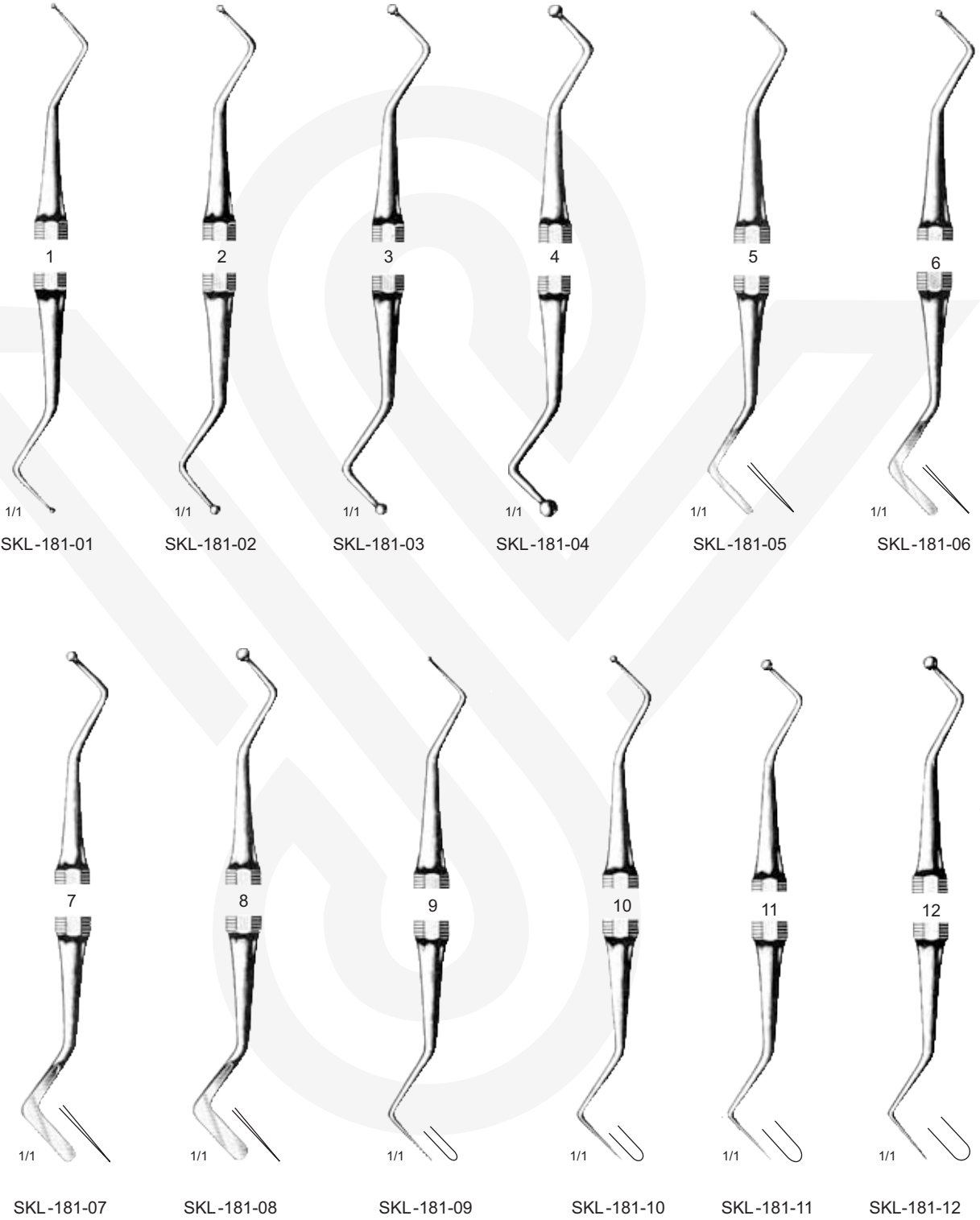
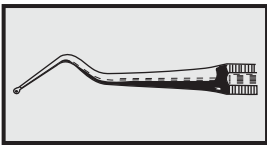

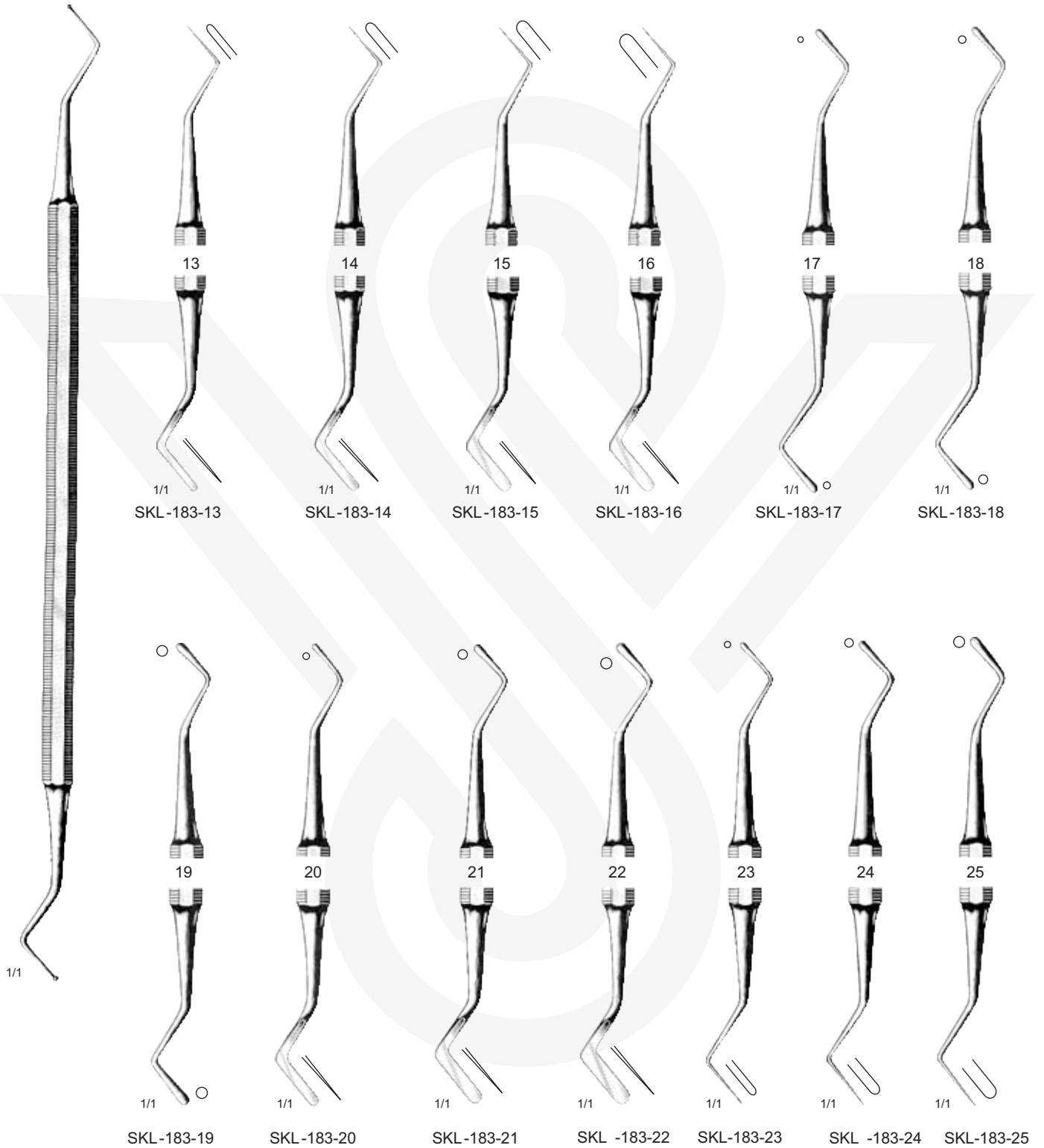
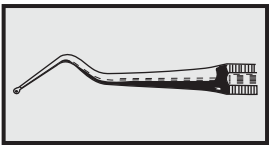

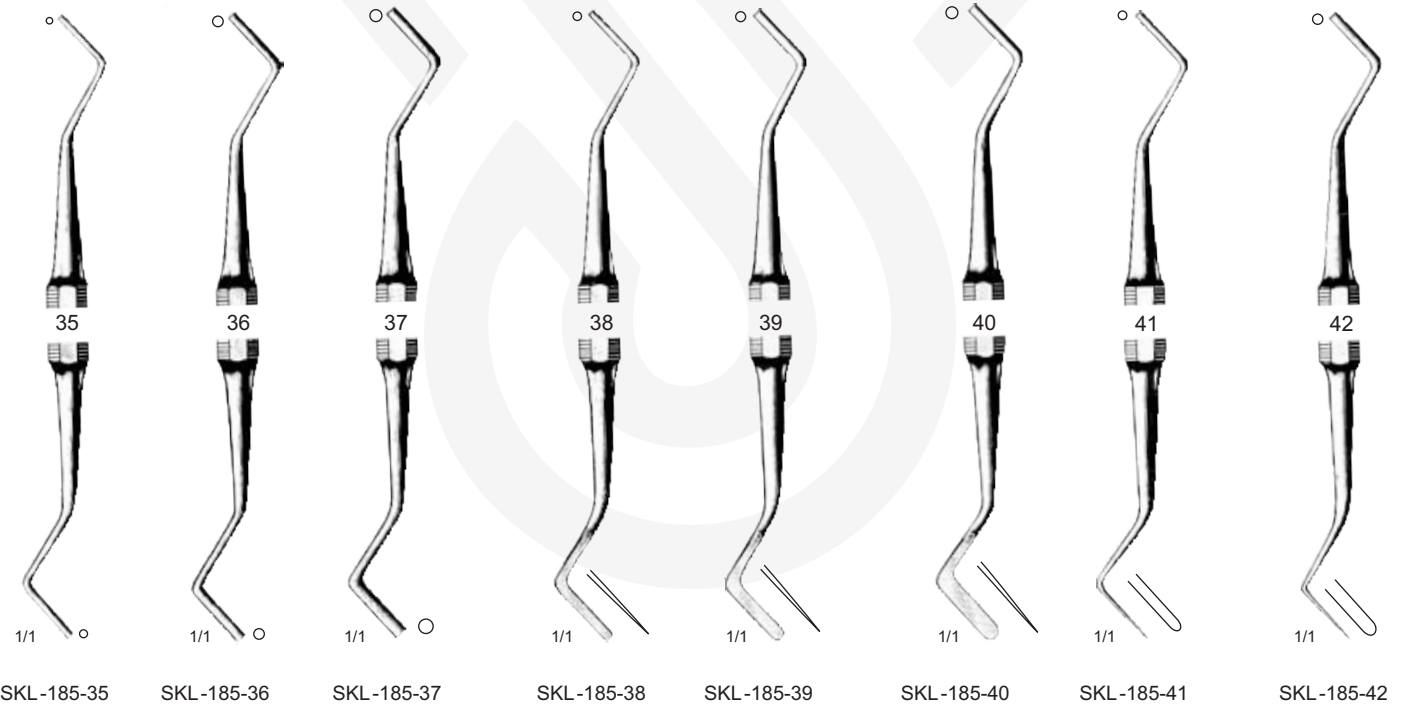
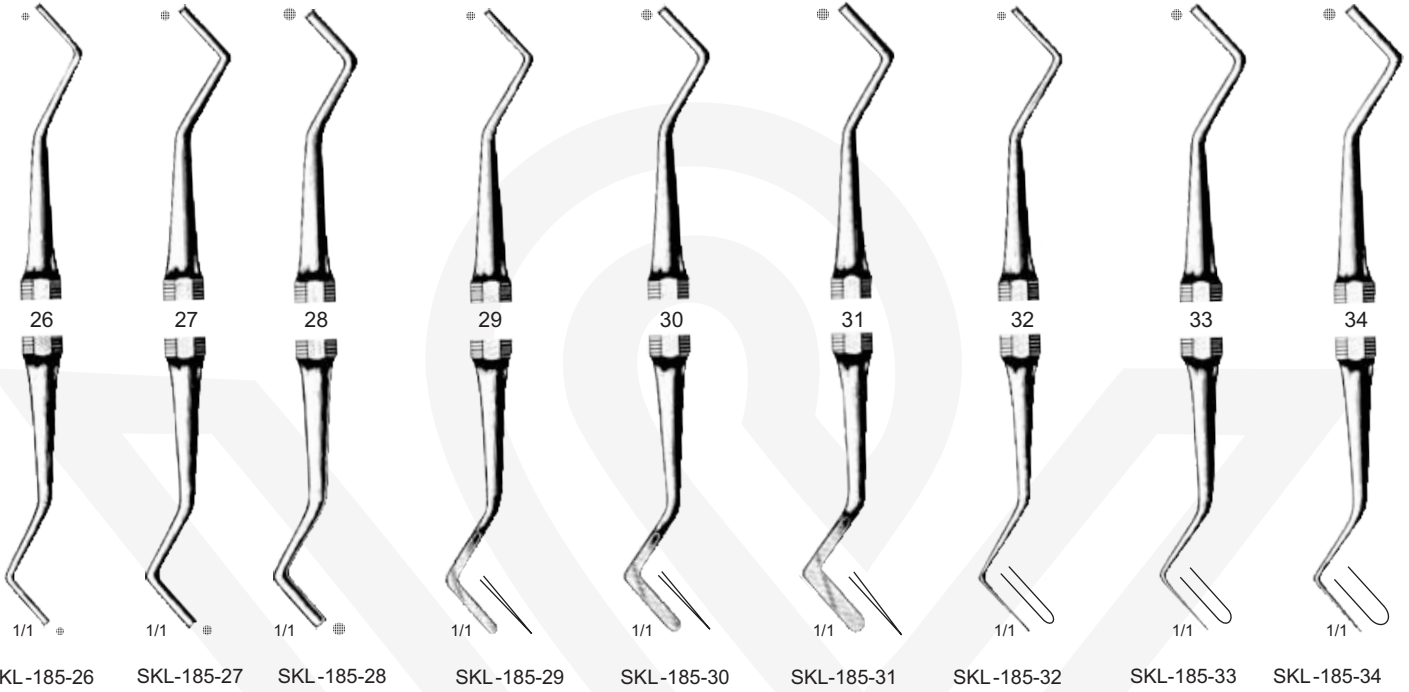
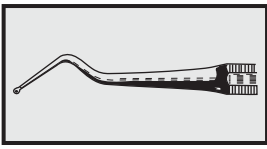

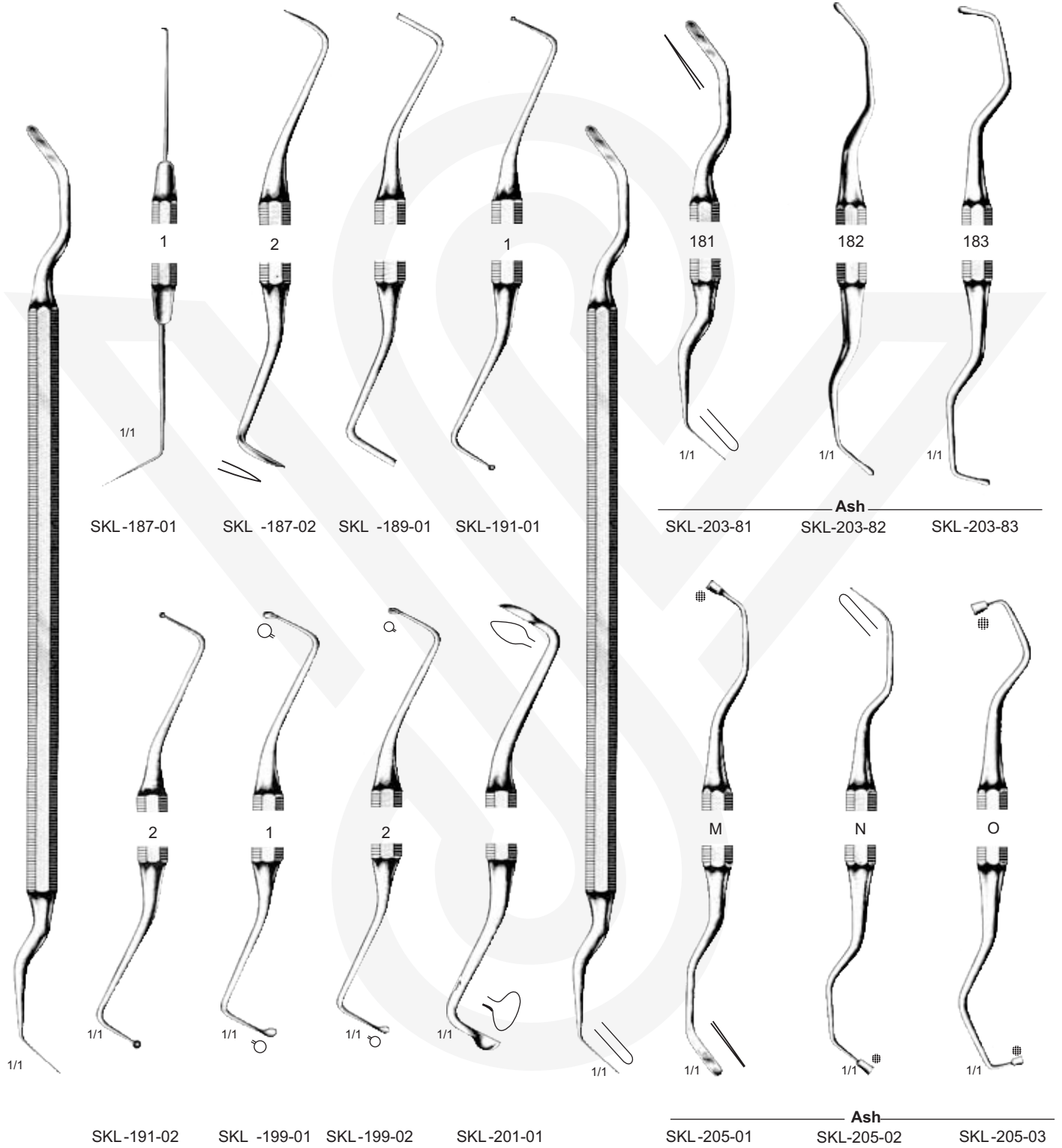
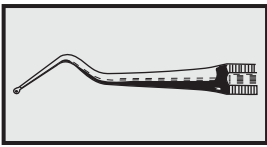

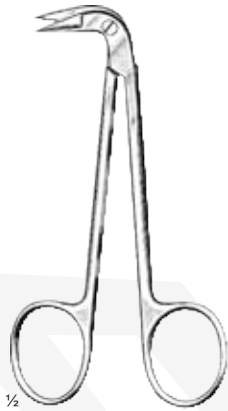

10.5 cm / 4"
SKL-145-10
Saw edge

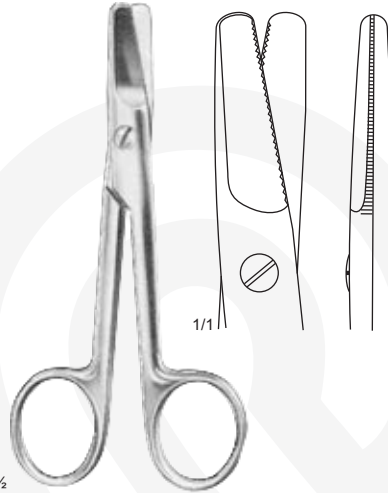

Harvey
12.5 cm / 5"
SKL-147-12



SKL-151-14
Curved

Sanvenero
14 cm / 5½"
SKL-149-14
Straight

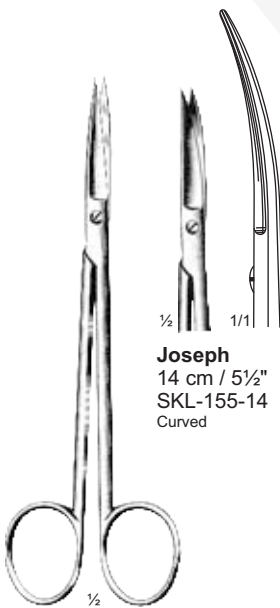

Joseph
14 cm / 5½"
SKL-155-14
Curved

Joseph
14 cm / 5½"
SKL-153-14
Straight



Lexer
16cm/6 ¼"
SKL-157-16
21cm/8 ½"
SKL-159-21

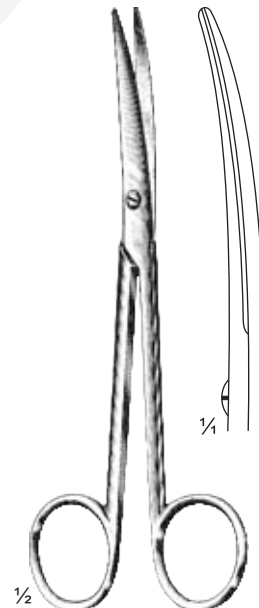

Lexer
16cm/6 ¼"
SKL-161-16
21cm/8 ½"
SKL-163-21

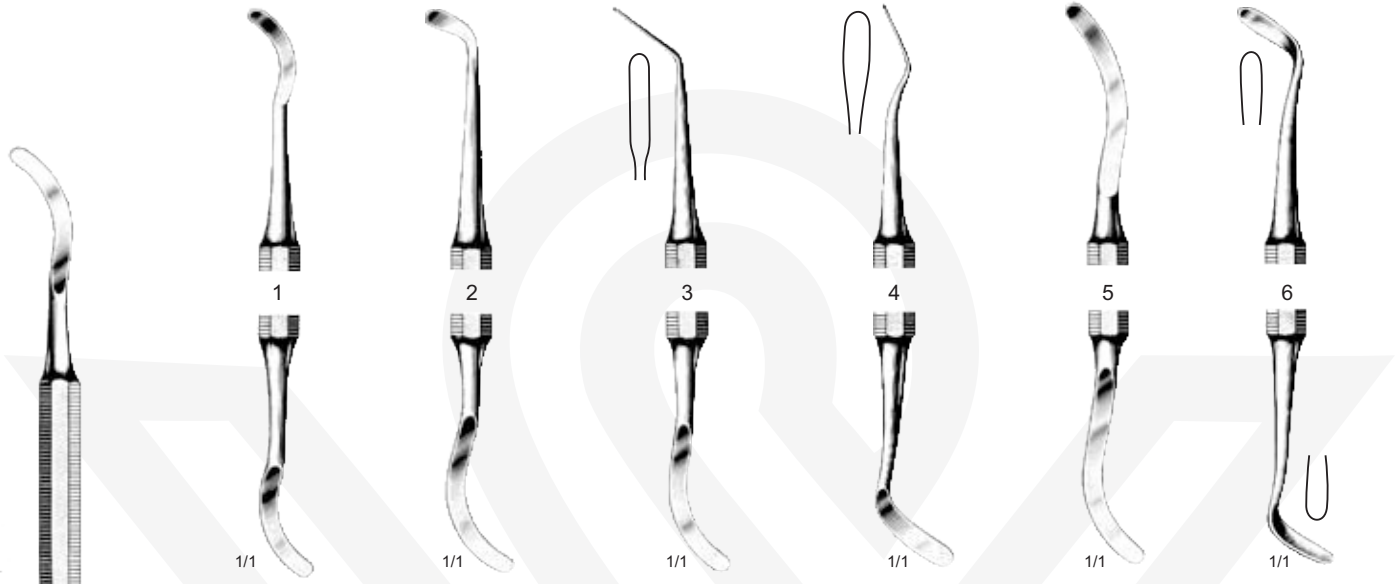
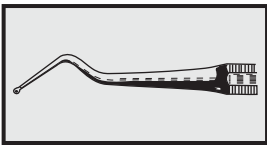

SKL-207-01 SKL-207-02 SKL-207-03 SKL-207-04 SKL-207-05 SKL-207-06

Linseman

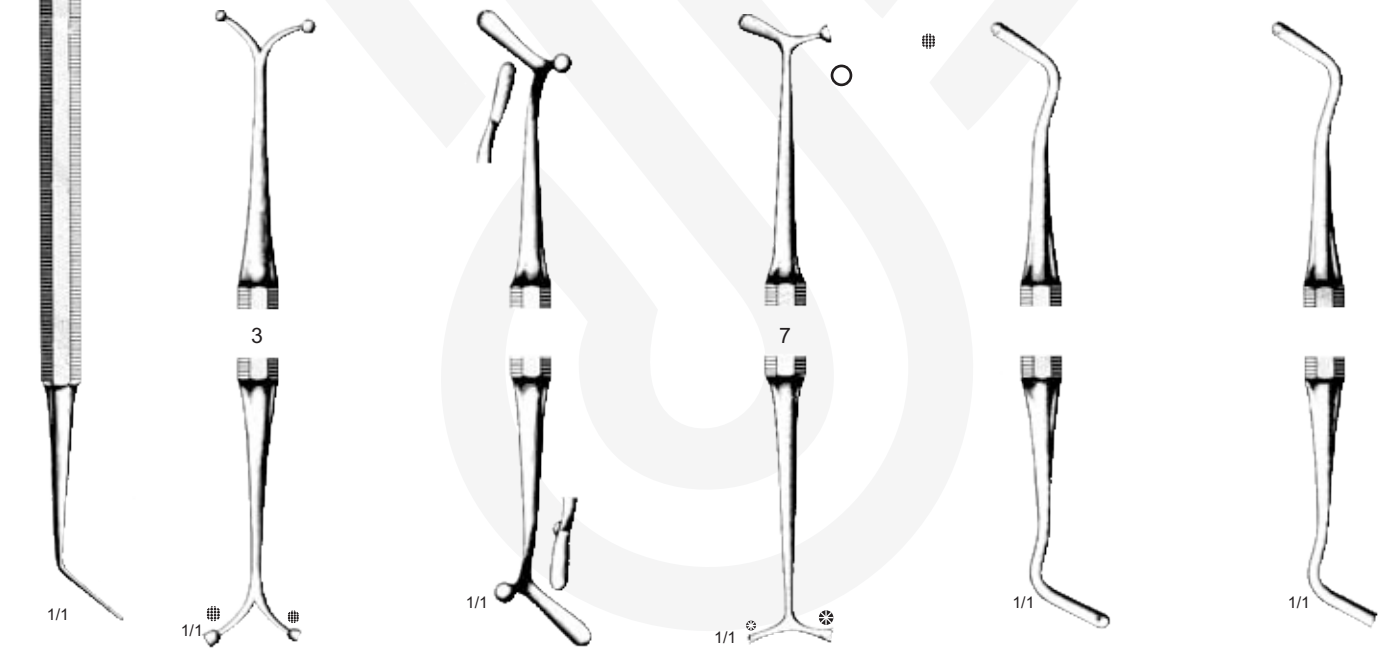

Vajna SKL-209-03 Vajna SKL-211-01 Bennet SKL-213-07 SKL-215-01 SKL-217-02

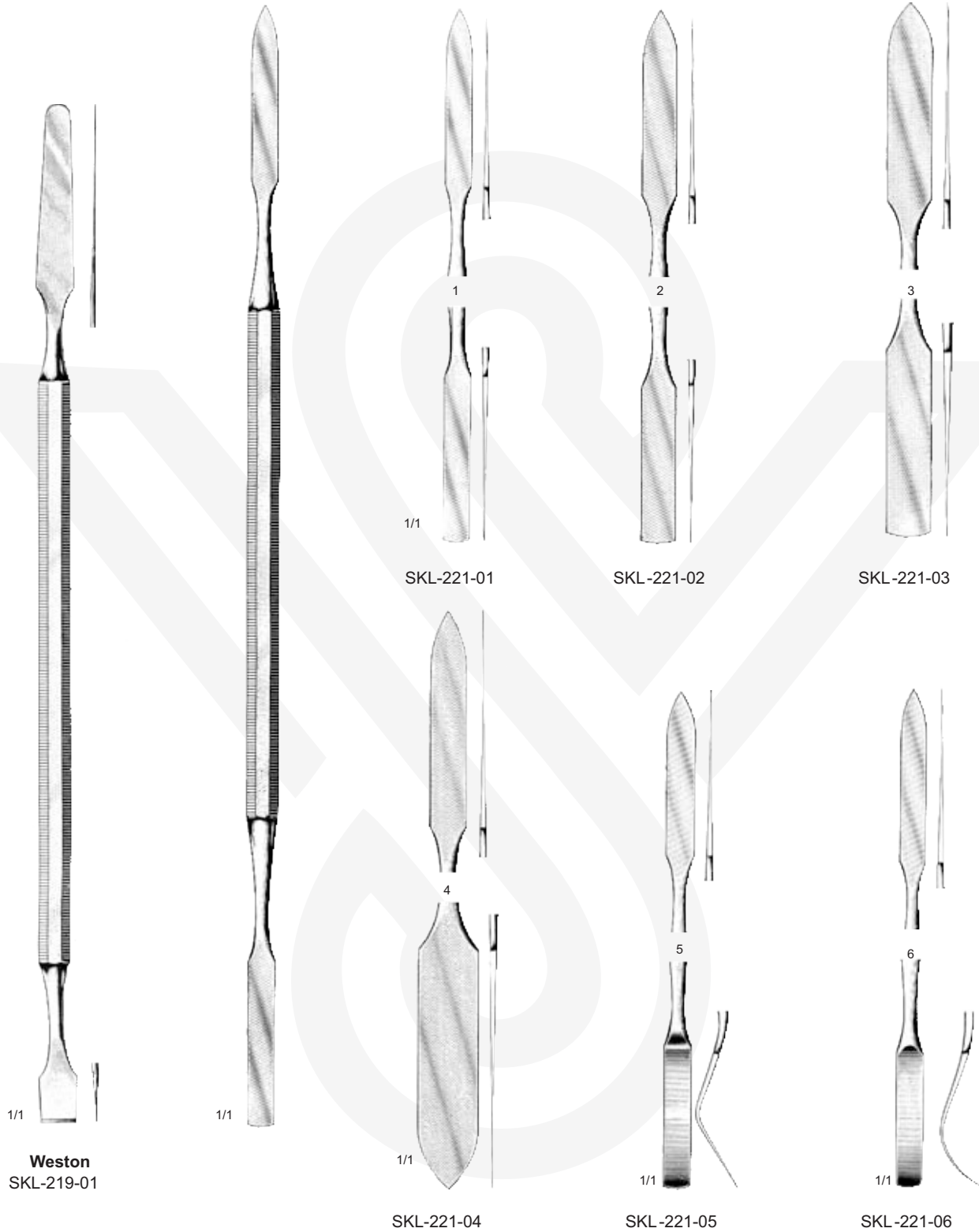
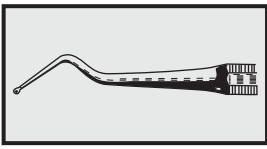

SKL-219-01 SKL-221-05 Cement Spatula

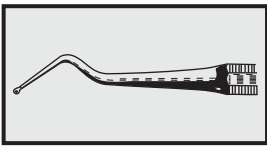

1/1

SKL-223-01



1/1

SKL-225-01



1/1

Mall-Roundoflex



1

1/1

SKL-227-01



2

SKL-227-02



3

1/1

SKL-227-03

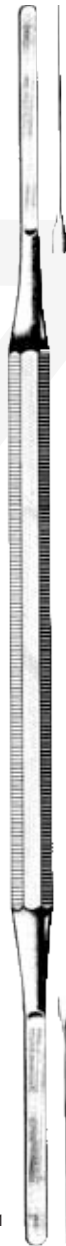

1/1

SKL-229-01

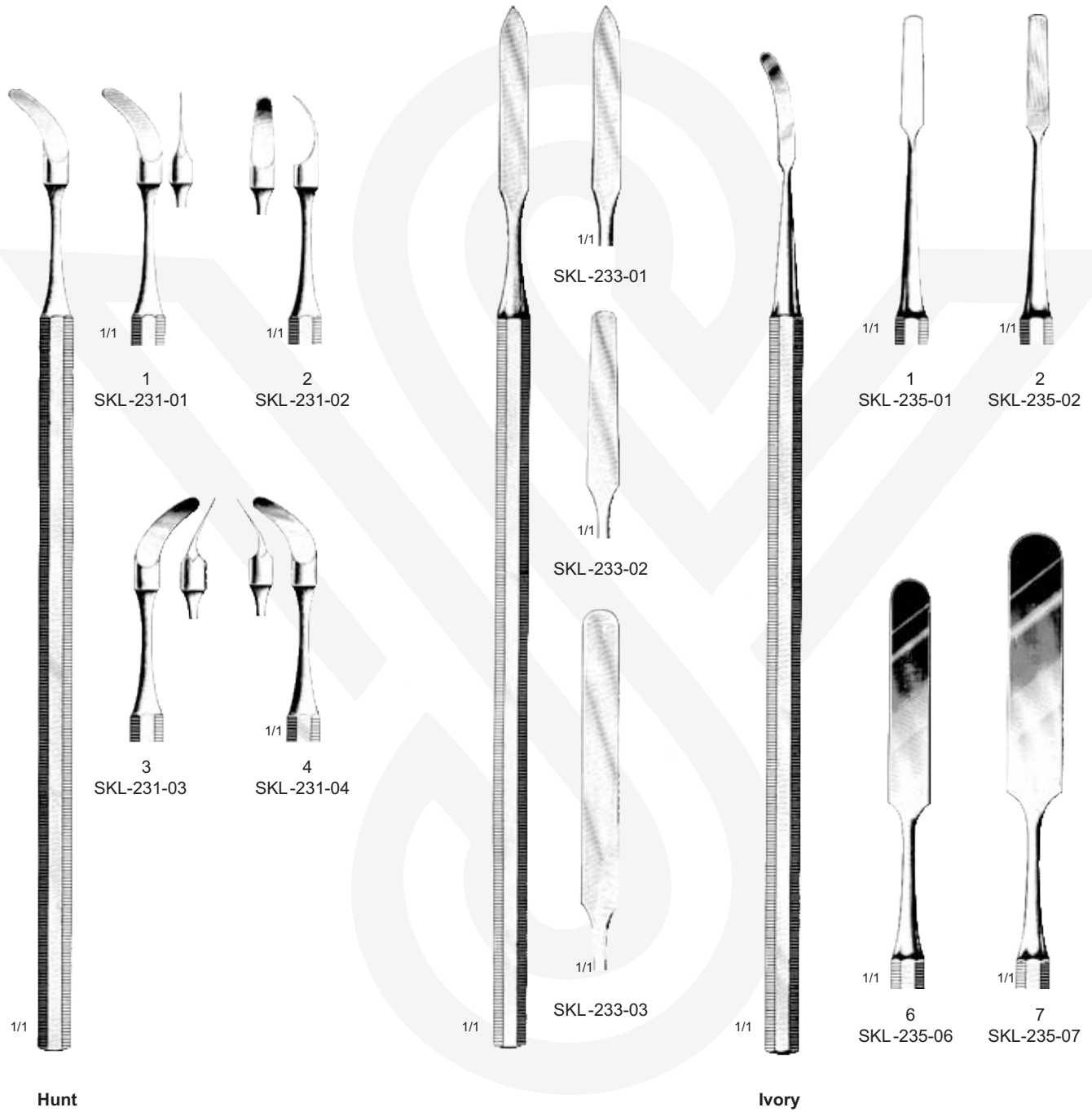
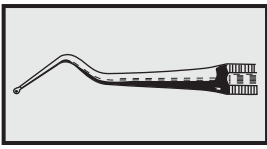

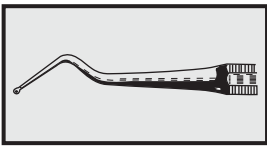

150 X 3 mm Ø
SKL-172-03



130 X 2 mm Ø SKL-237-02
185 x 2 mm Ø SKL-239-02
210 x 2 mm Ø SKL-241-02



SKL-243-02
SKL-245-02
SKL-247-02



100 X 2 mm Ø SKL-249-02
130 x 2 mm Ø SKL-251-02
150 x 2 mm Ø SKL-253-02



SKL-255-02
SKL-257-02
SKL-259-02



17.5 cm / 7"
SKL-207-17



150 X 3 mm Ø SKL-261-03
185 x 3 mm Ø SKL-263-03
210 x 3 mm Ø SKL-265-03



130 X 4 mm Ø SKL-267-04
155 x 4 mm Ø SKL-269-04



19 cm / 7½" SKL-271-19
22 cm / 8¼" SKL-273-22
25 cm / 10" SKL-275-25
28 cm / 11" SKL-277-28
30 cm / 12" SKL-279-30
35 cm / 14" SKL-281-35



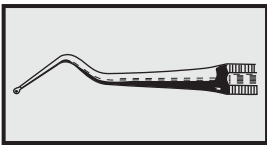

1/1

Didner
SKL-283-01



1/1

Ivory
SKL-285-01



1/1

Ivory
SKL-287-01



1/1

Ivory
SKL-289-01



SKL-291-20 = 20 mm Ø
SKL-291-25 = 25 mm Ø
SKL-291-30 = 30 mm Ø



1/1

Ivory
SKL-293-01



1/1

Ivory
SKL-295-01



1/1

Ivory
SKL-297-01

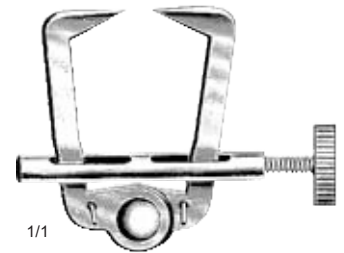

1/1

Elliot
SKL-299-01

SKL-283-01	SKL-289-01	Matrix Retainer
SKL-291-20	SKL-291-30	Rubber-dam Holder
SKL-293-01	SKL-295-01	Matrix Retainer
SKL-297-01	SKL-299-01	Separators

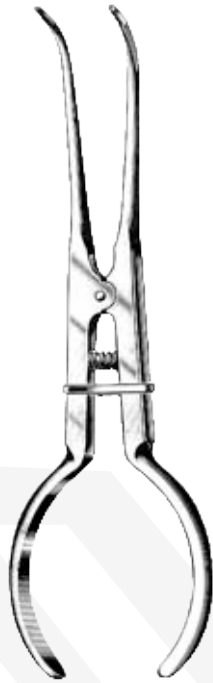
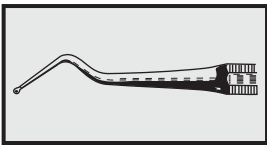

17 cm / 6¾"

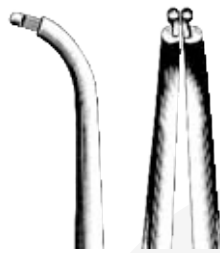

SKL-301-17



SKL-303-17



Brewer
17 cm / 6¾"
SKL-305-17



Ivory
17 cm / 6¾"
SKL-307-17

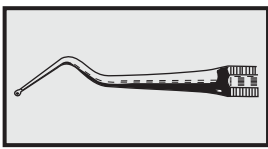

SKL-309-01



SKL-309-02



SKL-309-03



SKL-309-04



SKL-309-05



SKL-309-06

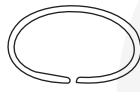

SKL-309-07



SKL-309-08

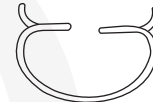

SKL-311-01



SKL-311-02



SKL-311-03



SKL-311-04



SKL-311-05



SKL-311-06



SKL-311-07



SKL-311-08



SKL-311-09

SKL-309-01	SKL-309-05	Molar Clamps
SKL-309-06	SKL-309-08	Bicuspid Clamps
SKL-311-01	SKL-311-06	Molar Clamps
SKL-311-07	SKL-311-09	Labial Clamps

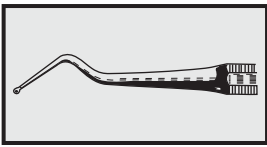

SKL-313-10



SKL-313-11



SKL-313-12



SKL-313-13



SKL-313-14



SKL-313-15



SKL-313-16



SKL-313-17



SKL-313-18



SKL-313-19



SKL-313-20



SKL-313-21



SKL-313-22



SKL-313-23



SKL-313-24



SKL-313-25



SKL-313-26



SKL-313-27

SKL-313-10	SKL-313-14	Molar Clamps
SKL-313-15	SKL-313-20	Molar Clamps
SKL-313-21	SKL-313-27	Bicuspid Clamps

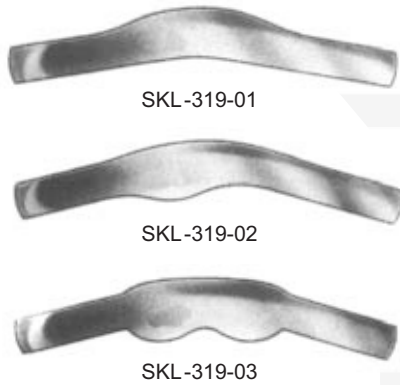
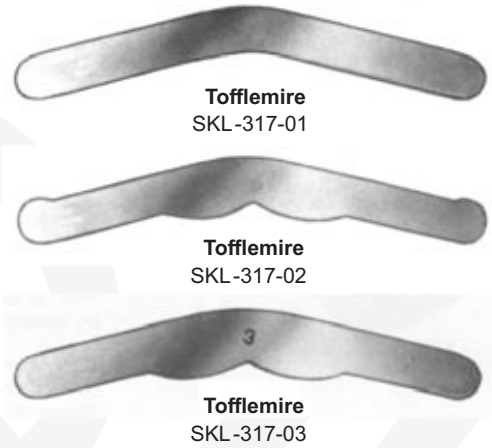
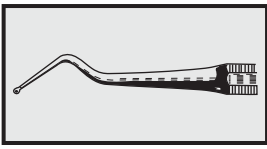

Tofflemire-Universal
SKL-321-01

Tofflemire-Junior
SKL-321-02

Tofflemire-Senior
SKL-321-03

SKL-315-01	SKL-319-03	Matrix Bands
SKL-321-01	SKL-321-03	Matrix Retainer



½
Metzenbaum
14.5 cm / 5½"
SKL-165-14
saw edge, straight



½
Metzenbaum
14.5 cm / 5½"
SKL-167-14
saw edge, curved

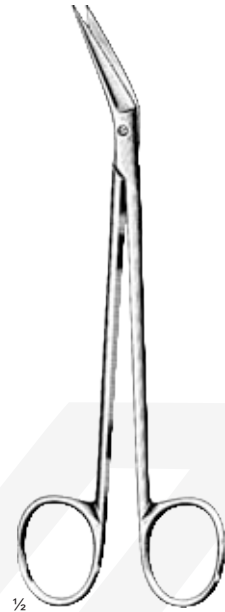

½
Locklin
16 cm / 6¼"
SKL-173-16
saw edge



½
Modell USA
18 cm / 7"
SKL-175-18

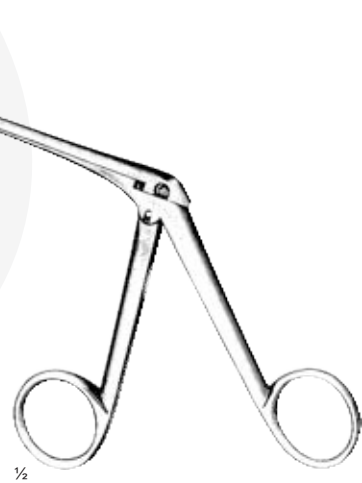
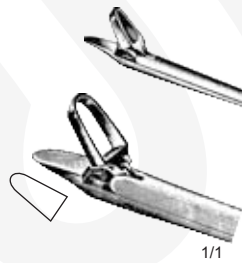

½
Tomati
19 cm / 7½"
SKL-177-19

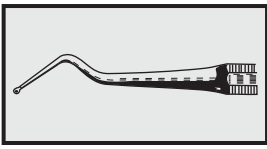

Periodontitis Instruments

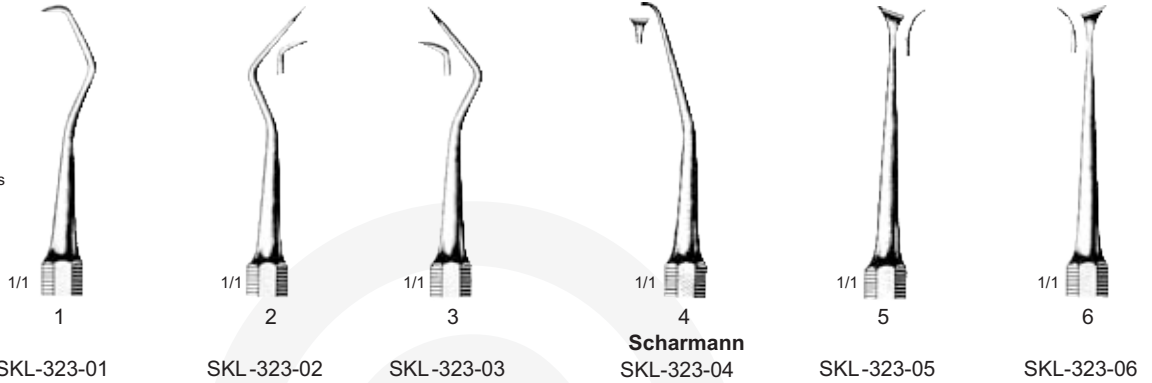

Periodontitis Instruments



Periodontitis Instruments



Files for Prophylaxis

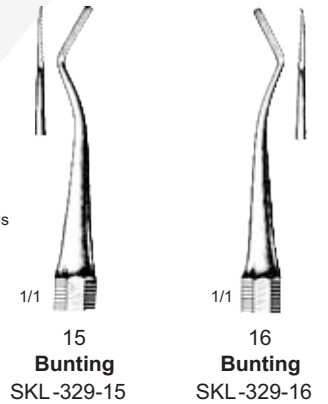

Files for Prophylaxis

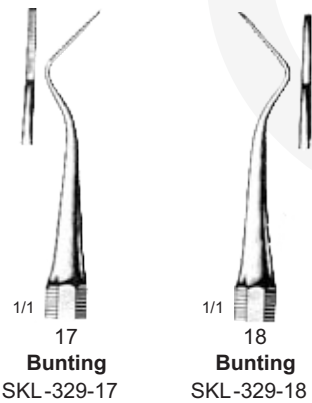

Pyorrhea Instruments

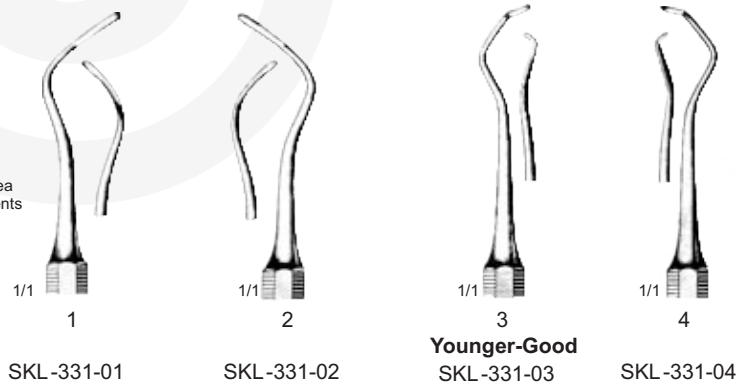

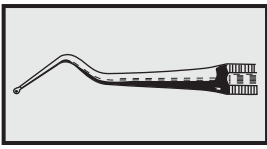

Pyorrhea Instruments

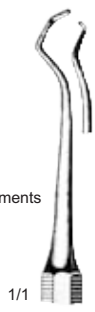

5
Younger-Good
SKL-333-05



6
Younger-Good
SKL-333-06



7
Younger-Good
SKL-333-07



8
Younger-Good
SKL-333-08



9
Younger-Good
SKL-333-09



10
Younger-Good
SKL-333-10

Pyorrhea Instruments



11
Younger-Good
SKL-333-11



12
Younger-Good
SKL-333-12



13
Younger-Good
SKL-333-13



14
Younger-Good
SKL-333-14



15
Younger-Good
SKL-333-15

Pyorrhea Instruments



Globe
SKL-335-02

Periodontitis Files



Muehleemann
SKL-337-07



Muehleemann
SKL-337-08

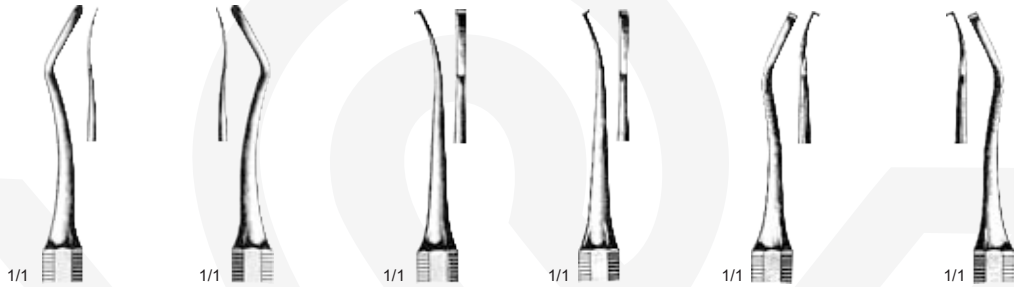
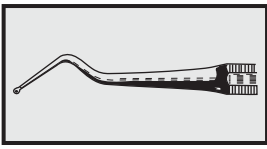

Black					
1	2	3	4	5	6
SKL-339-01	SKL-339-02	SKL-339-03	SKL-339-04	SKL-339-05	SKL-339-06
15	15	15	15	15	15
8	8	F	B	8	8
6	6			6	6
L	R			L	R

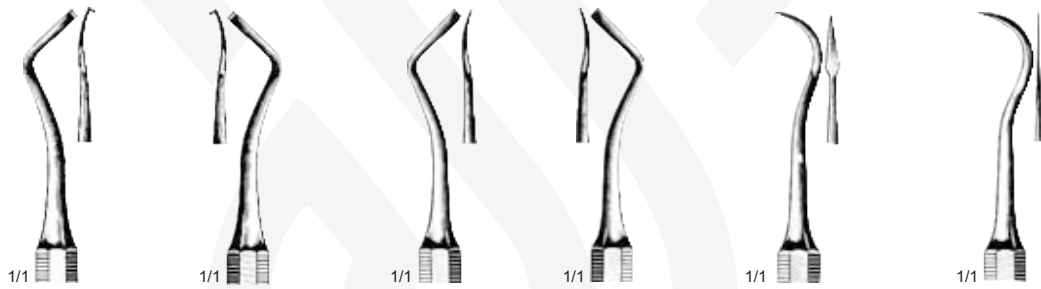

Black					
7	8	9	10	11	12
SKL-339-07	SKL-339-08	SKL-339-09	SKL-339-10	SKL-339-11	SKL-339-12
15	15	15	15	25	20
8	8	8	8		
6	12	12	12		
R	R	L	R		

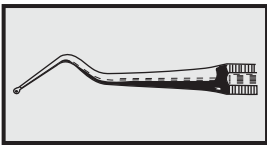

1/1



1/1
15
Cleveland
SKL-344-15



1/1
12B
SKL-345-12



1/1
1
SKL-345-01



1/1
2
SKL-345-02



1/1
3
SKL-345-03

White



1/1
13Z
Zerfing
SKL-347-13



1/1
Whiten
SKL-349-01



1/1
01
Moore
SKL-351-01



1/1
02
Moore
SKL-351-02



1/1
1
SKL-353-01



1/1
2
Jaquette
SKL-353-02



1/1
3
SKL-353-03

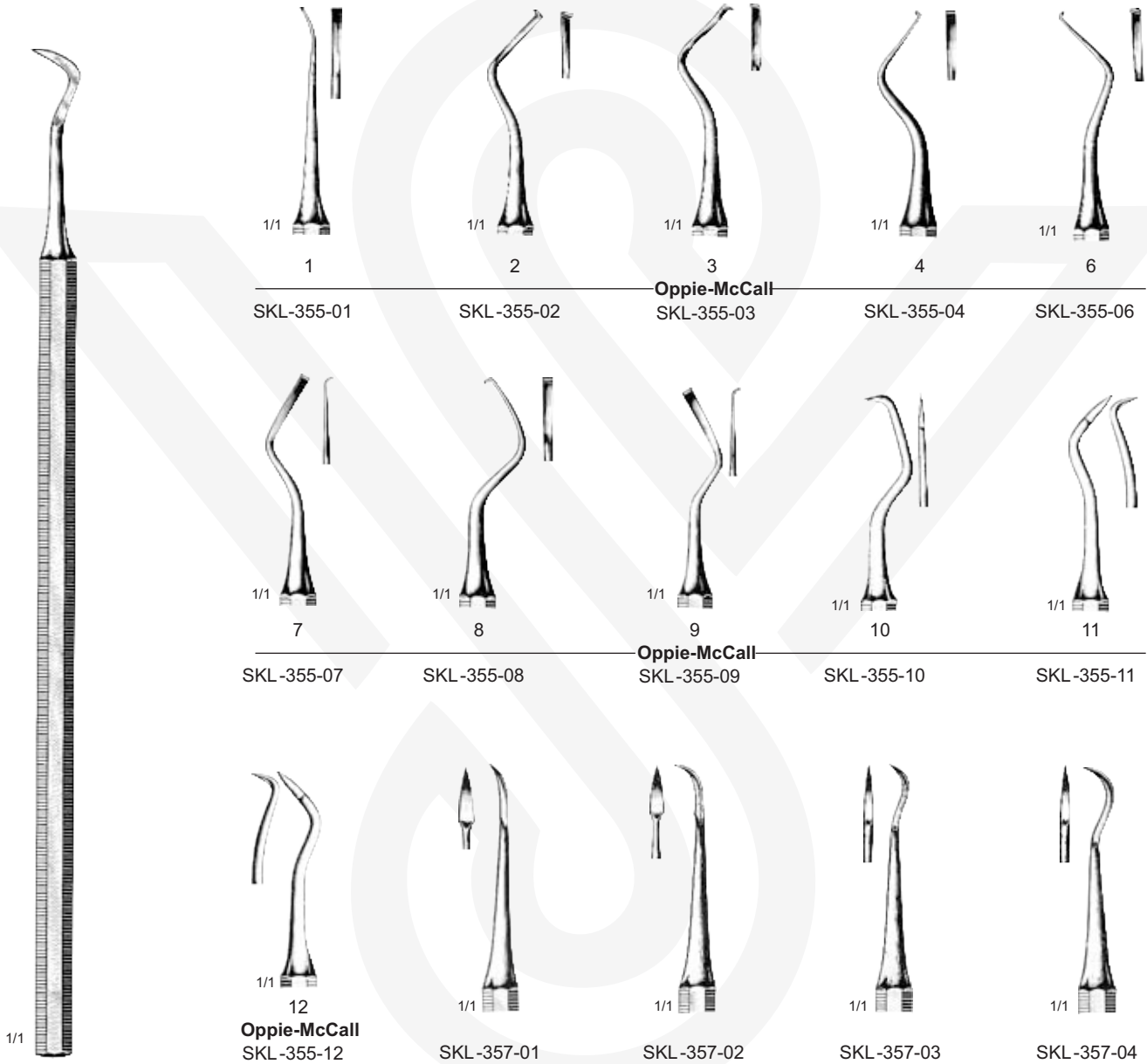
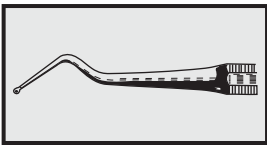

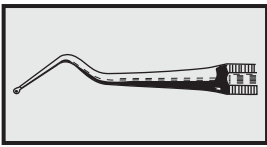

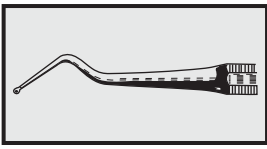

1/1

Cumine
SKL-361-02



1/1

Mitchell
SKL-363-02



1/1

Guenther
SKL-365-02



1/1

33/34
SKL-367-02

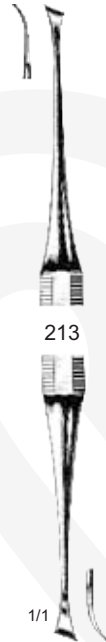

213

1/1

SKL-369-13



229

1/1

SKL-369-29



230

1/1

SKL-369-30



232

1/1

SKL-369-32



233

1/1

SKL-369-33



235

1/1

SKL-369-35



261

1/1

SKL-369-61



262

1/1

SKL-369-62

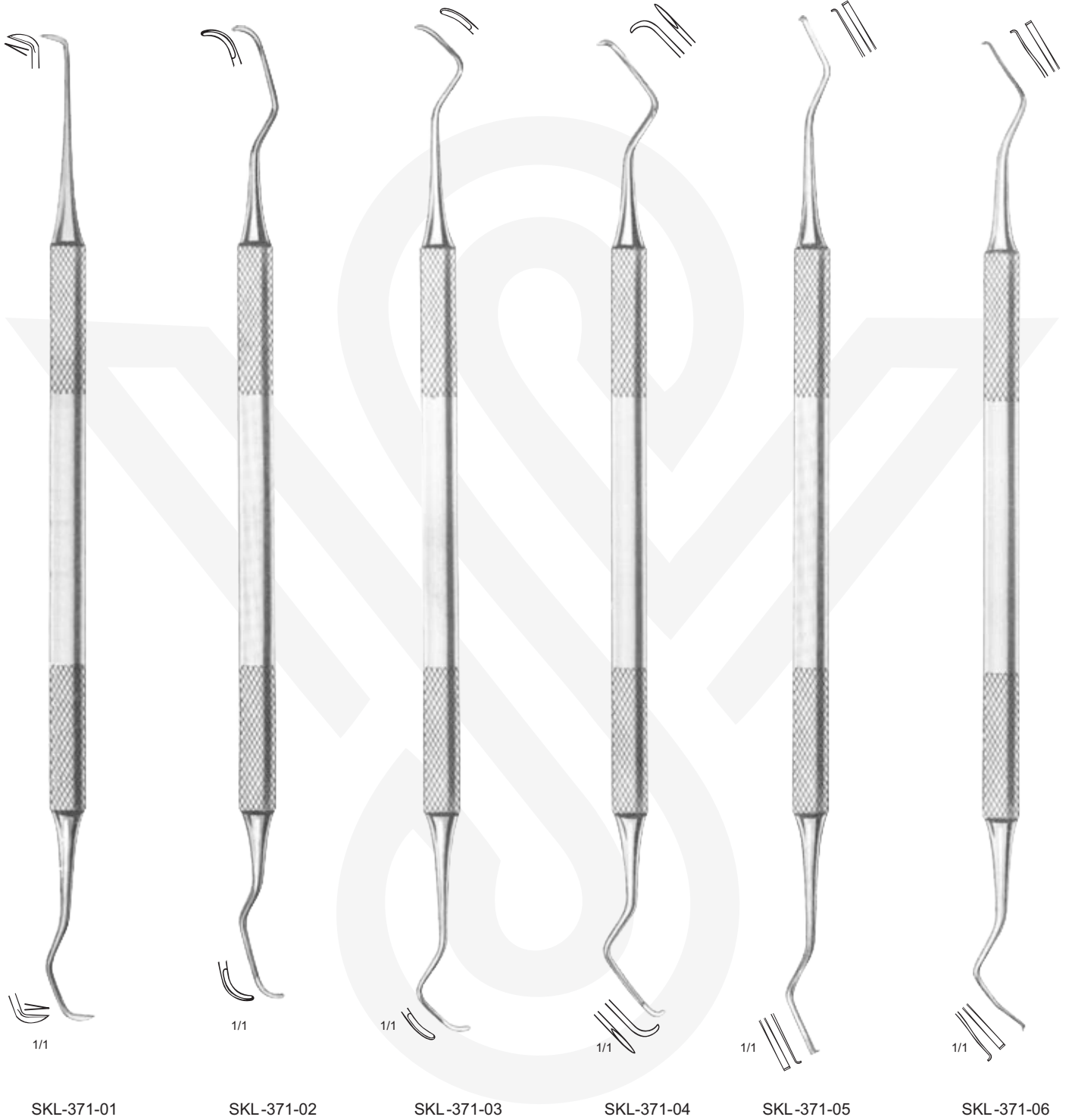
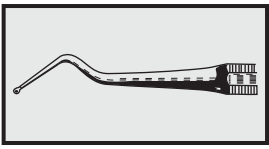

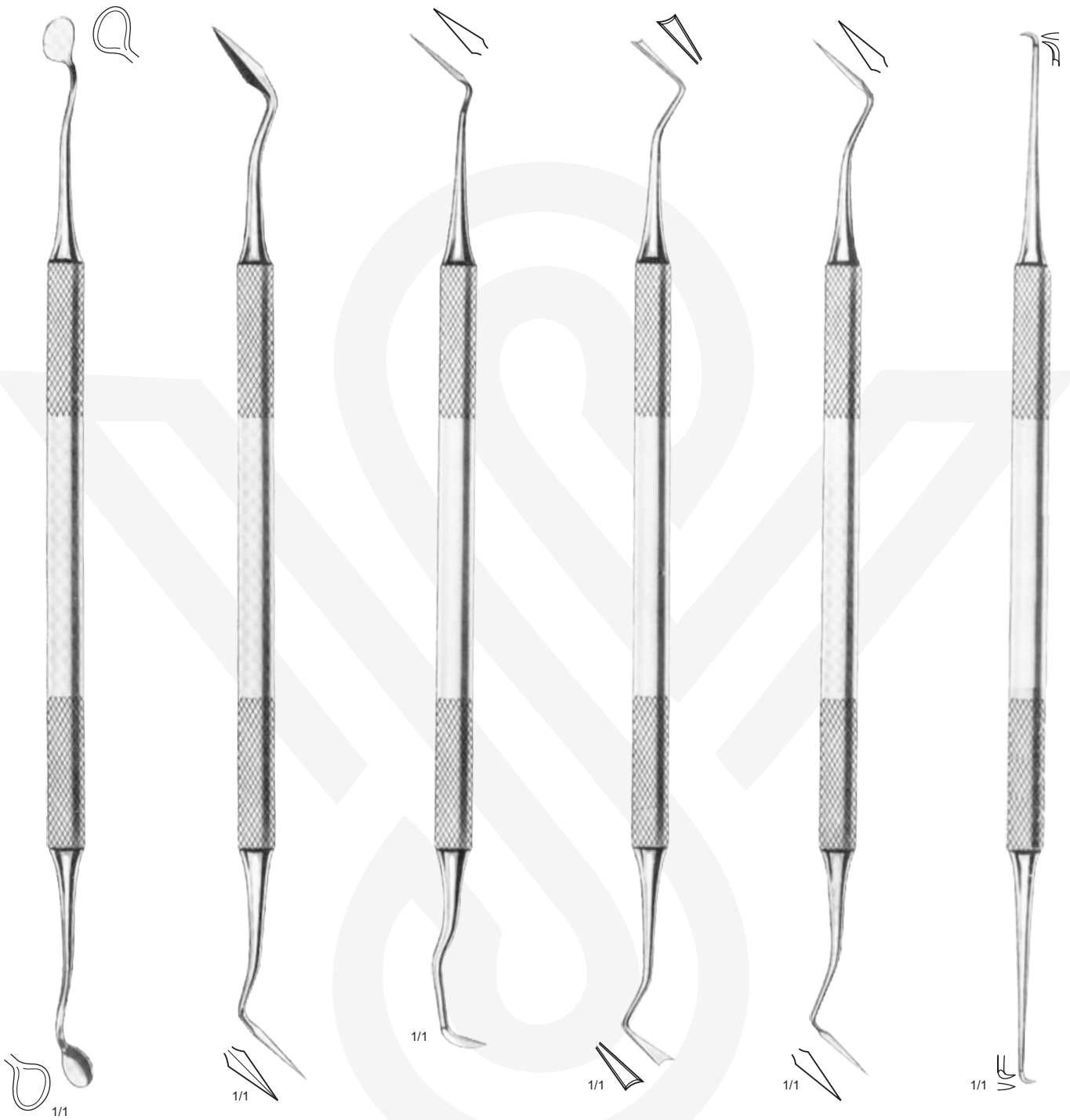
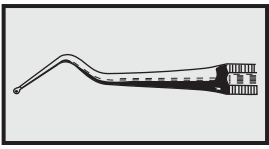

SKL-371-07

SKL-371-08

SKL-371-09

SKL-371-10

SKL-371-11

SKL-371-12

SKL-371-07	SKL-371-11	Gingivectomy Knives
	SKL-371-12	Scaler, double-ended

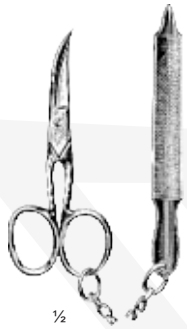

10 cm / 4"
SKL-179-10



10.5 cm / 4 1/4"
SKL-181-10

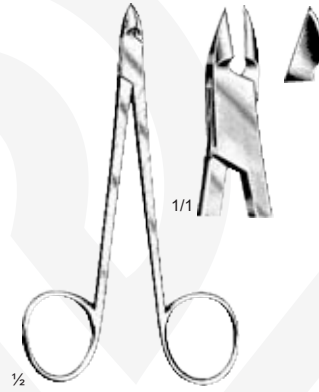

10.5 cm / 4 1/4"
SKL-183-10

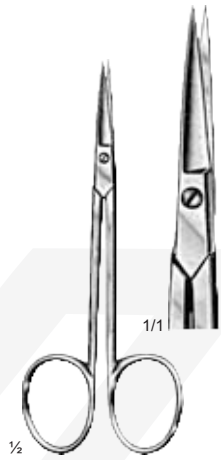

10 cm / 4"
SKL-185-10

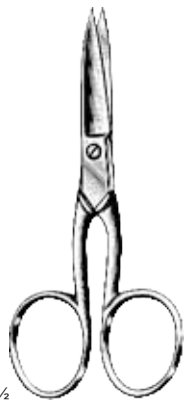

9 cm / 3 1/2" SKL-187-09
10 cm / 4" SKL-187-10
11 cm / 4 1/2" SKL-187-11

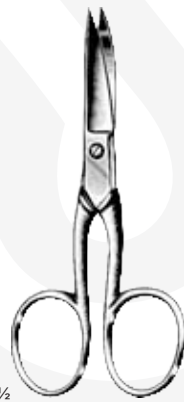

9 cm / 3 1/2" SKL-189-09
10 cm / 4" SKL-189-10
11 cm / 4 1/2" SKL-189-11

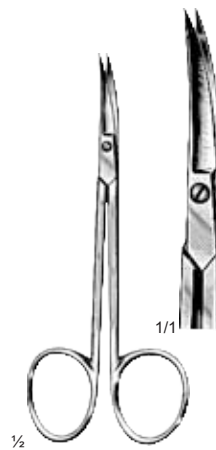

10 cm / 4" SKL-191-10
11 cm / 4 1/2" SKL-191-11

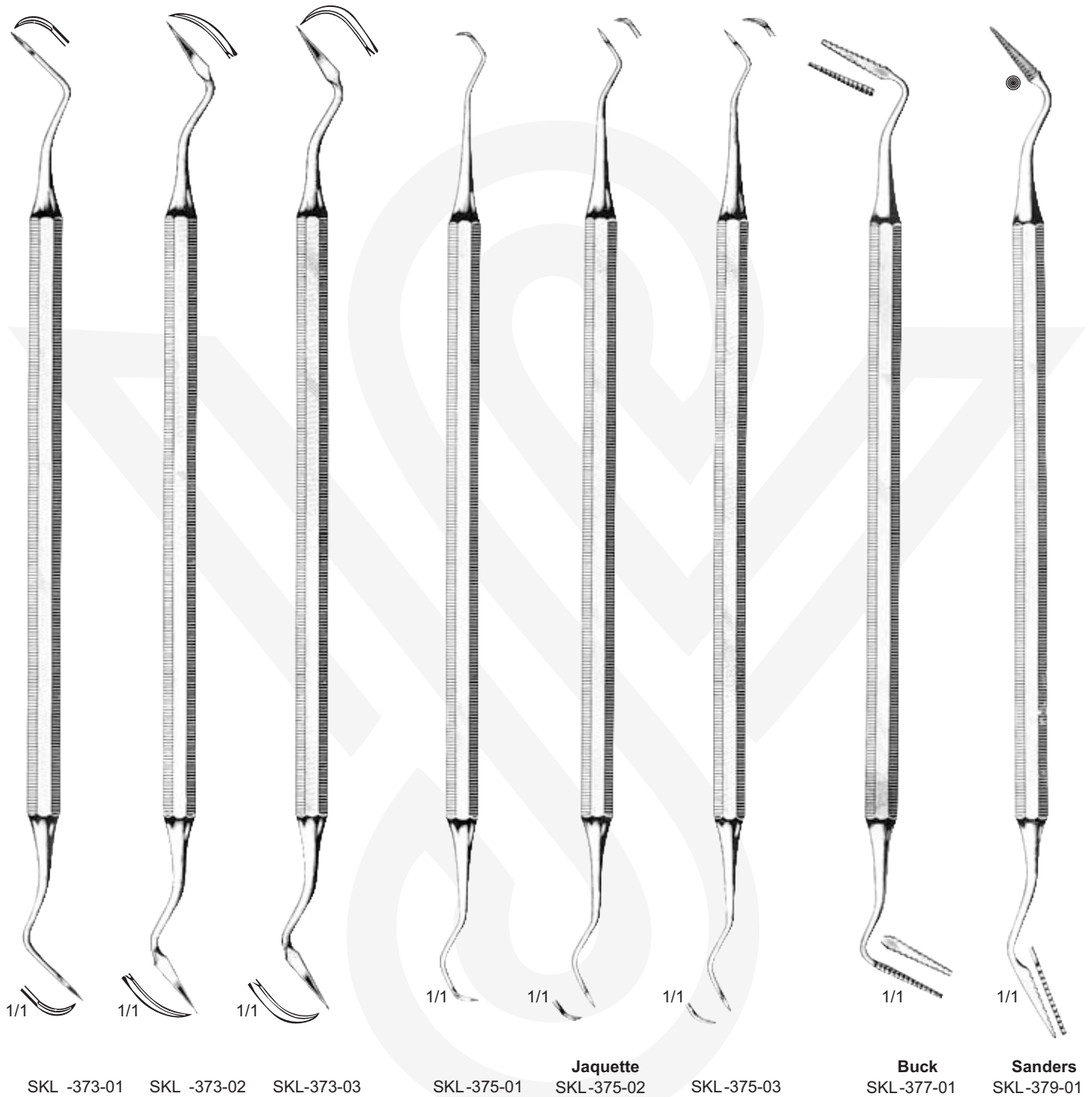
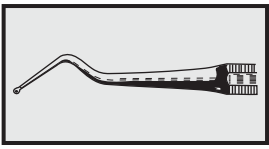

SKL -373-01	SKL -375-03	Scalers double-ended
SKL-377-01	SKL-379-01	Interproximal Trimmers

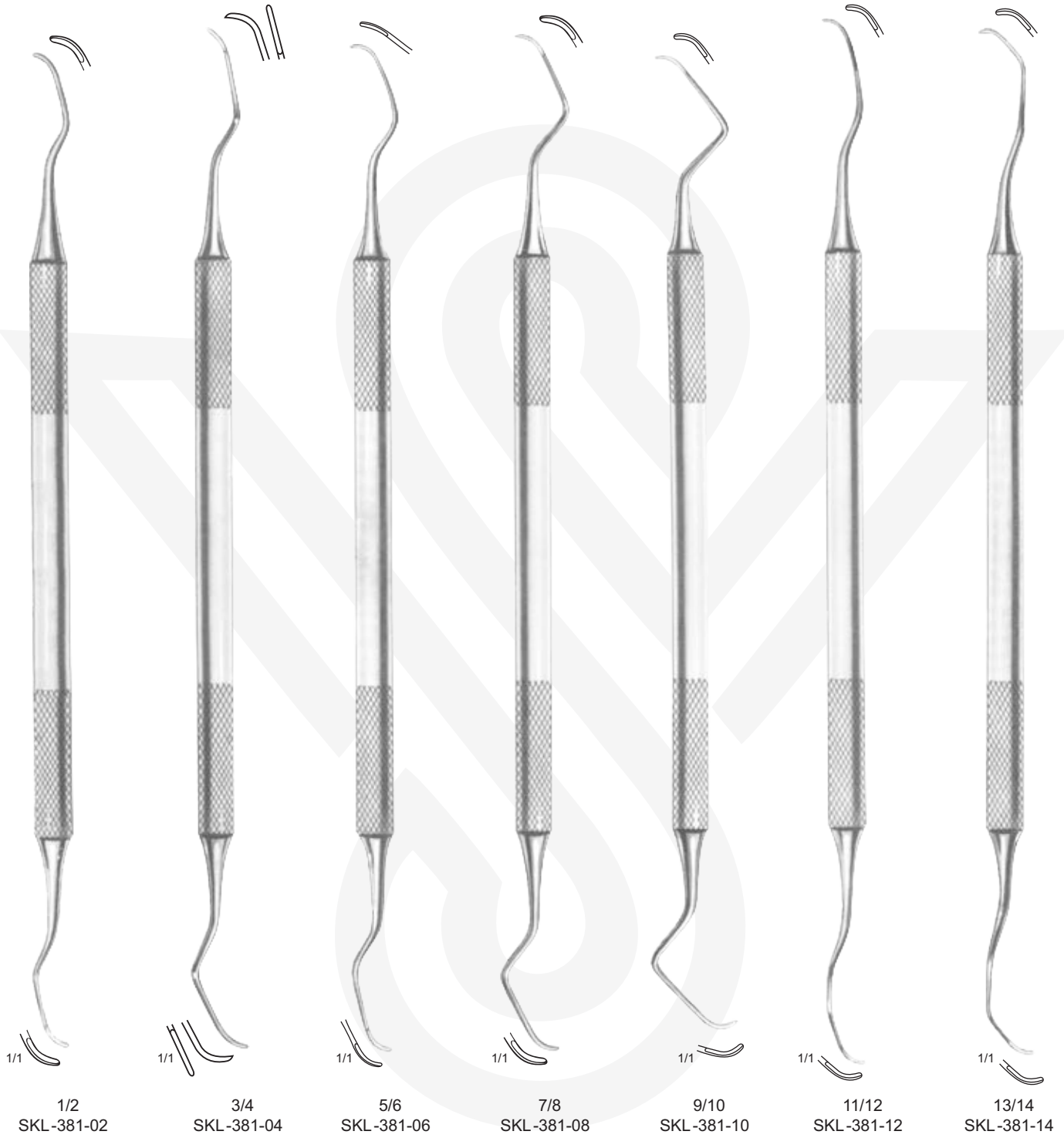
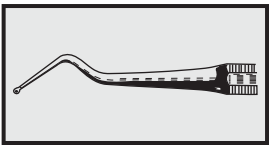

SKL-381-02 SKL-381-14 Scalers

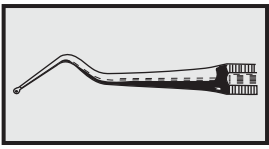

Krenn
SKL-383-01

Krenn
SKL-385-02

Zeibe
SKL-387-01

Zeibe
SKL-389-02

SKL-383-01	SKL-385-02	Loops
SKL-387-01	SKL-389-02	Gum Probes with Eye

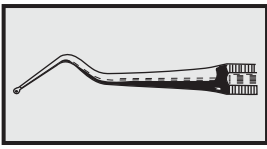

1/1

Crane-Kaplan
SKL-173-30



1/1

Crane-Kaplan
SKL-175-30



1/1

SKL-393-01



1/1

SKL-395-01



1/1

SKL-395-02



Krenn
SKL-397-02

SKL-173-30	SKL-175-30	Pocket markers
SKL-393-01	SKL-397-02	Probes for measuring gum pockets

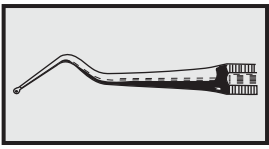

SKL-399-01	SKL-399-07	Finishing Files
SKL-401-01	SKL-403-01	Loops
SKL-405-01	SKL-405-03	Gingivectomy Knives

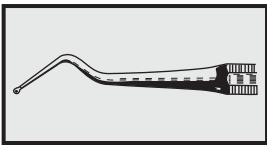

Mercitan

SKL-407-01 SKL-407-02

Ward-Kirkland

SKL-409-01 SKL-409-02 SKL-409-03 SKL-409-04 SKL-409-05

SKL-407-01 SKL-409-05 Scalers, Single-ended

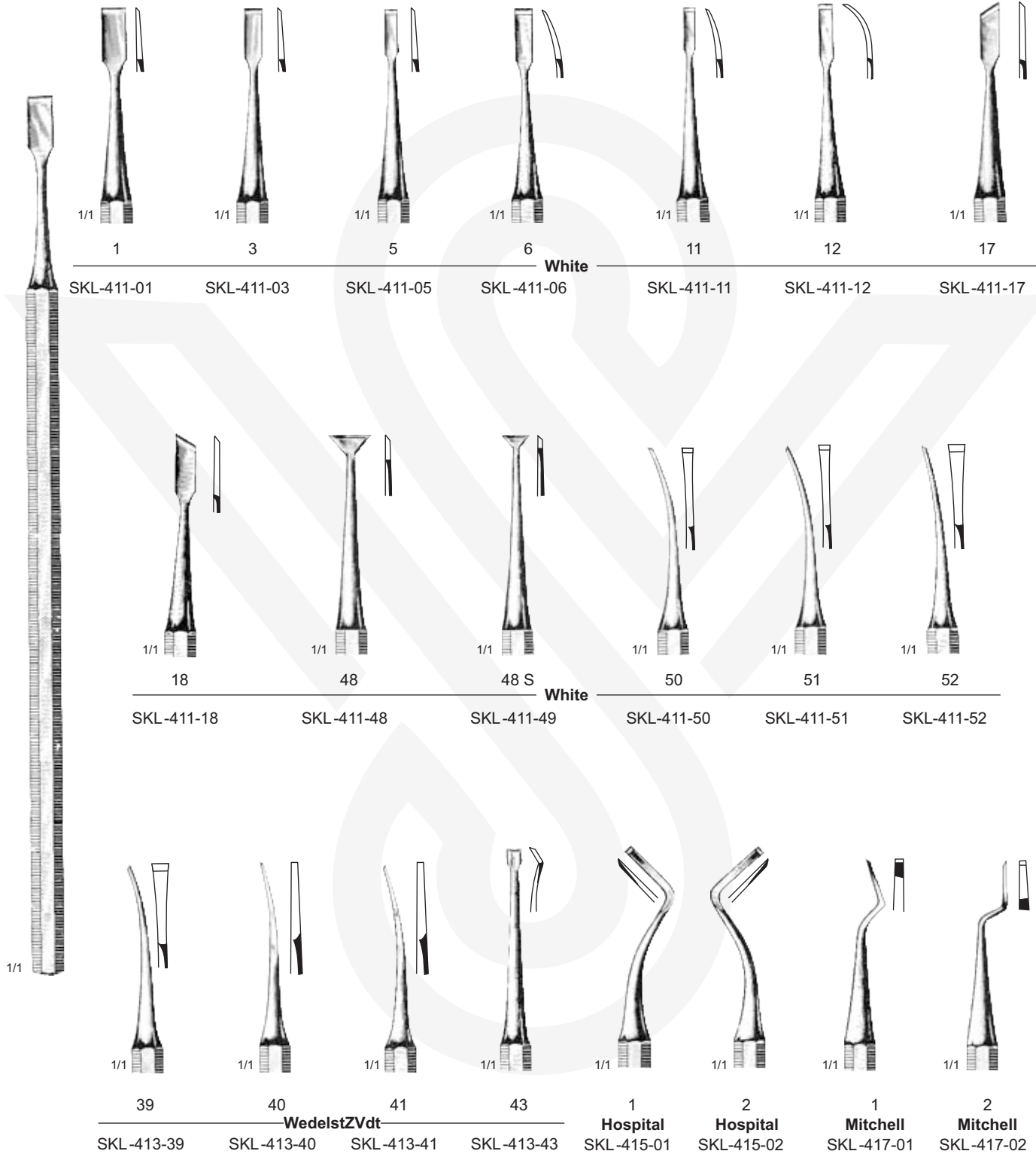
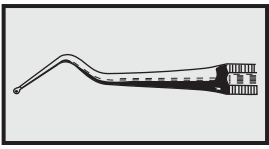

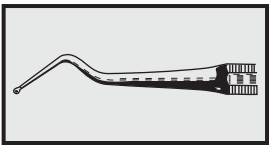

Fliege
SKL-419-01

Tuft
SKL-421-01

Tuft
SKL-421-02

Frahm
SKL-423-01

Ward
SKL-425-01

Ward
SKL-427-02

Gritman
SKL-429-01

Waerhaug
SKL-431-01

3
Hollenback
SKL-433-30

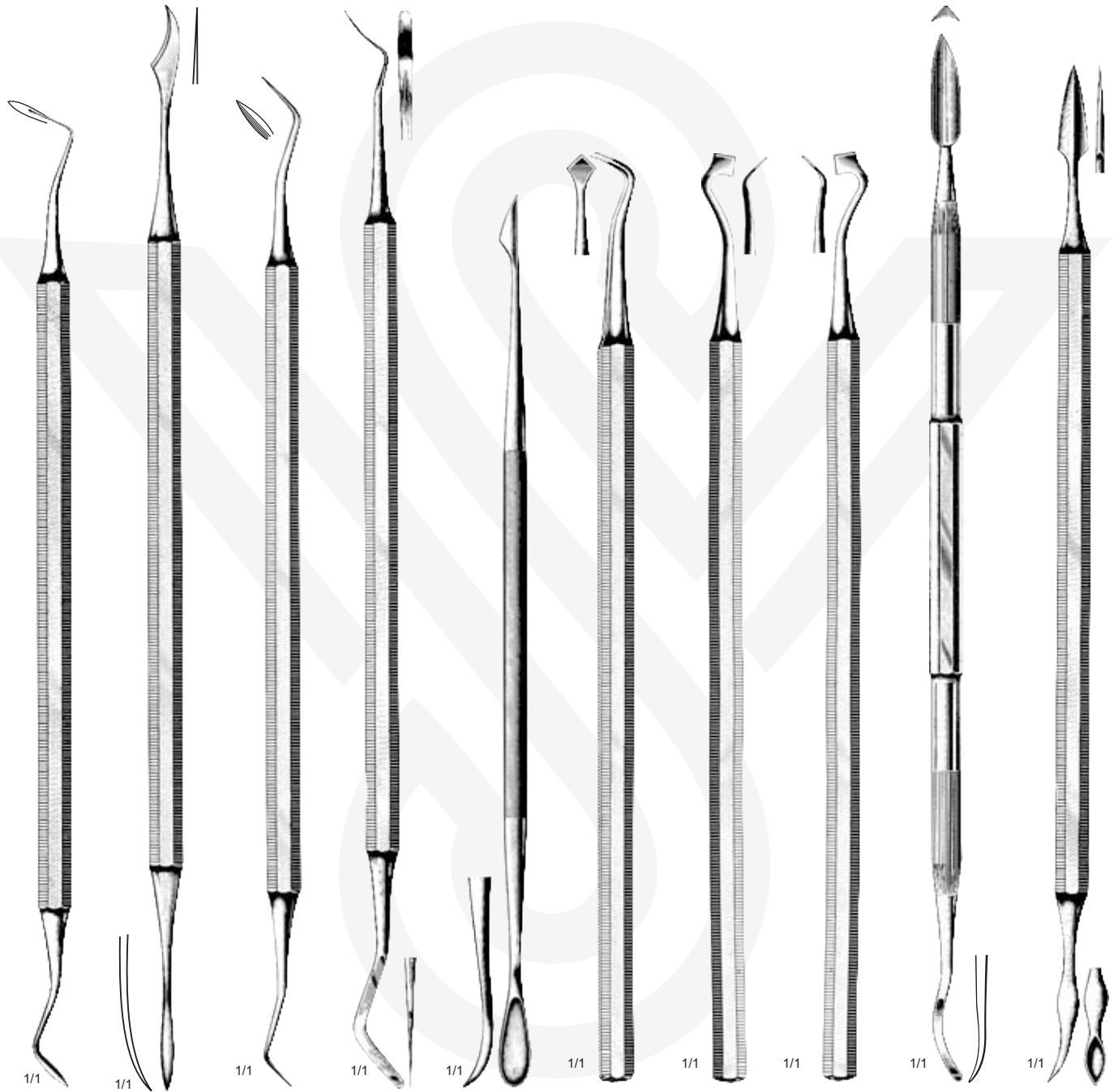
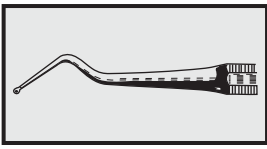

3S
Hollenback
SKL-435-31

No. 5
SKL-437-01

Shooshan
SKL-439-01

1/1
SKL-441-01

1/1
SKL-443-01

1
Frahm
SKL-445-01

2
Frahm
SKL-445-02

3
Frahm
SKL-445-03

1/1
SKL-447-01

1/1
Roach
SKL-449-01

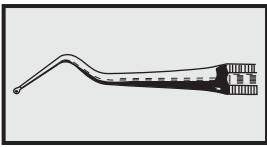

Roach
SKL-451-02

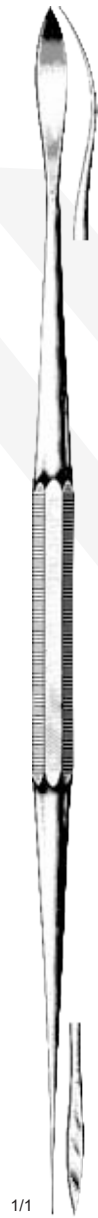

Riegner
SKL-453-01



Evans
SKL-455-01



Evans
SKL-457-01



Vehe
SKL-459-01



Wolff
SKL-461-01

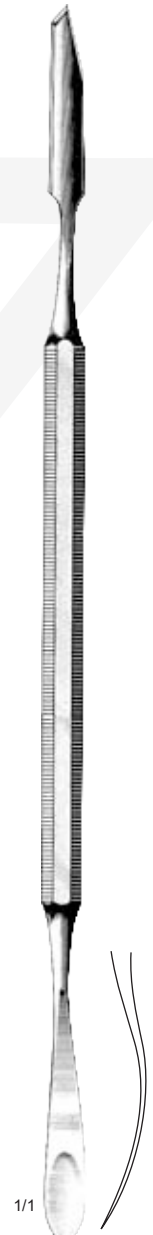

Fjeldstad
SKL-463-01

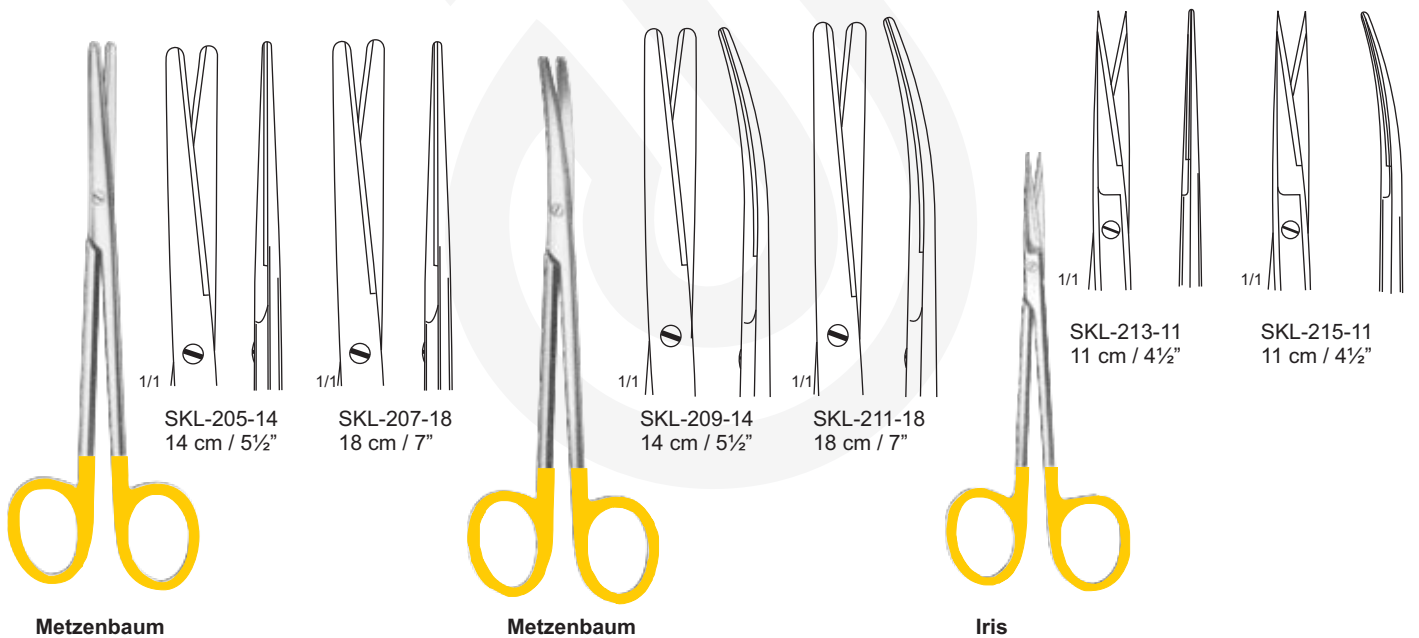

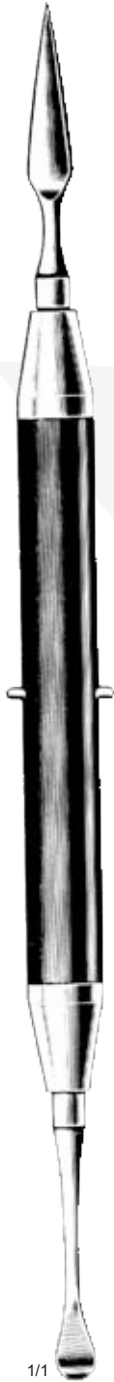
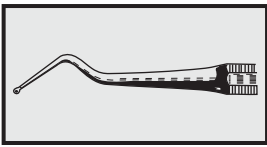

Acker
SKL-465-01



Falck
SKL-467-01



Falck
SKL-469-01



Beale
SKL-471-01



Ermert
SKL-473-01



Ermert
SKL-475-01



Gisy-Wild
15 cm / 6"
SKL-477-15

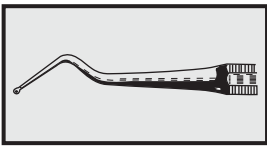

Gritman

SKL-479-01

SKL-481-01

Cerafix

SKL-483-01

Fahnenstock

13 cm / 5"
SKL-485-13

Fahnenstock

17 cm / 6 3/4"
SKL-485-17

Lessmann

13 cm / 5"
SKL-487-13

Lessmann

17 cm / 7"
SKL-487-17

Antkoviak

12.5 cm / 5"
SKL-489-12

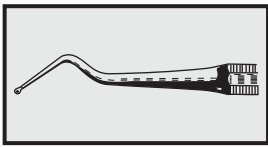

Zahle
SKL-491-01

Hylin
SKL-493-01

Zahle
SKL-495-01

Le Cron
SKL-497-01

Le Cron
SKL-499-01

Le Cron
SKL-501-01

Le Cron
SKL-503-01

Le Cron
SKL-505-01

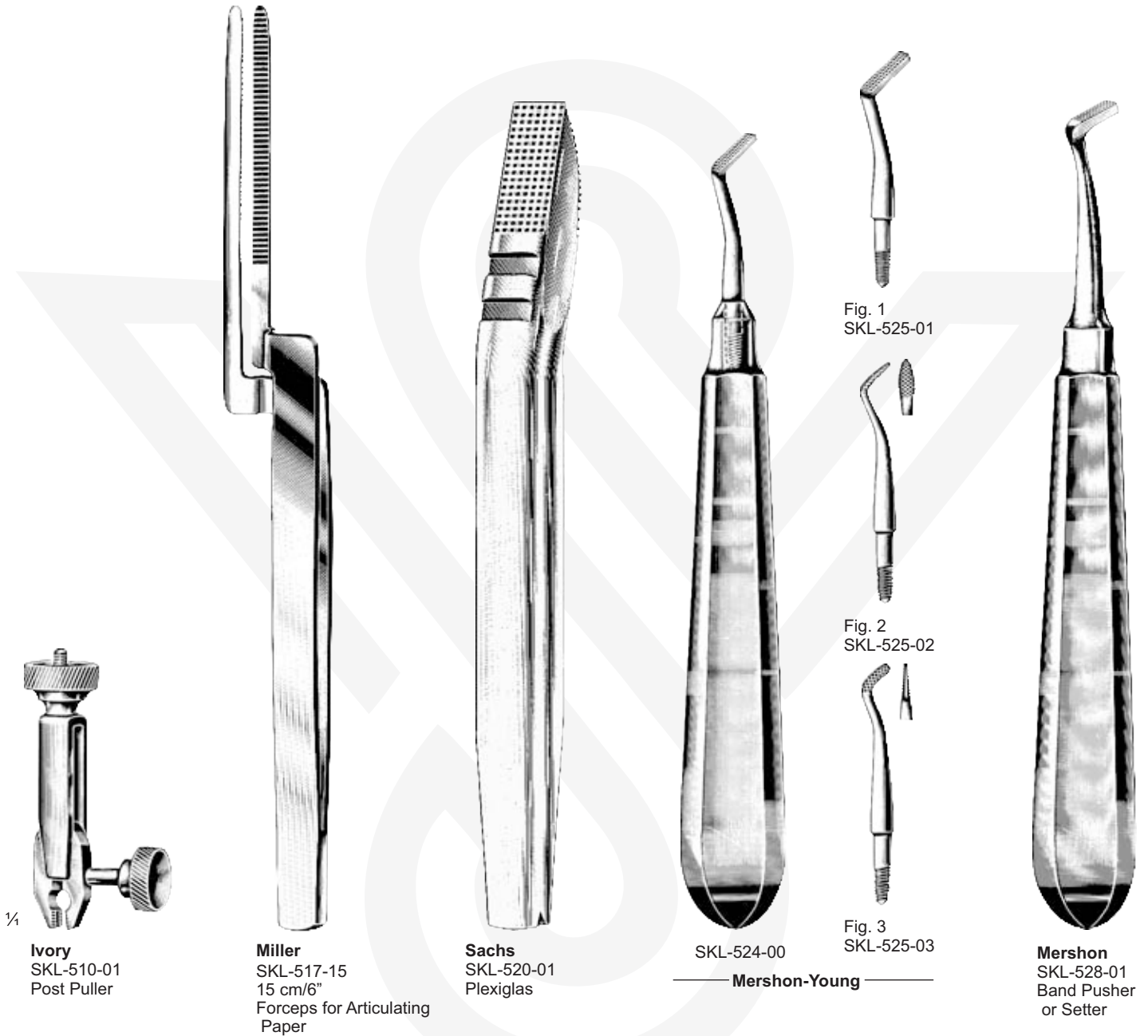
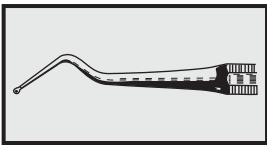

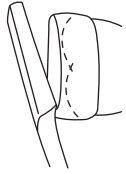
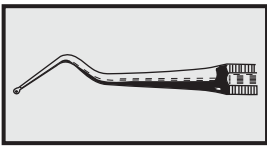

Swivel Lid for removing pins easily

2/3

SKL-555-00
55 mm Ø 17 mm

	Fig.	
	1	SKL-552-01
	2	SKL-552-02
	3	SKL-552-03
	4	SKL-552-04
	5	SKL-552-05
	6	SKL-552-06
	7	SKL-552-07
	8	SKL-552-08
	9	SKL-552-09
	10	SKL-552-10
	14	SKL-552-14
	15	SKL-552-15

1/4



1/4

SKL-530-01



Steiner
SKL-532-01



Mod. Paris
SKL-5DC34-01



SKL-540-01



SKL-549-30
10 m/32 ft. 10 in. x 0.3 mm Ø



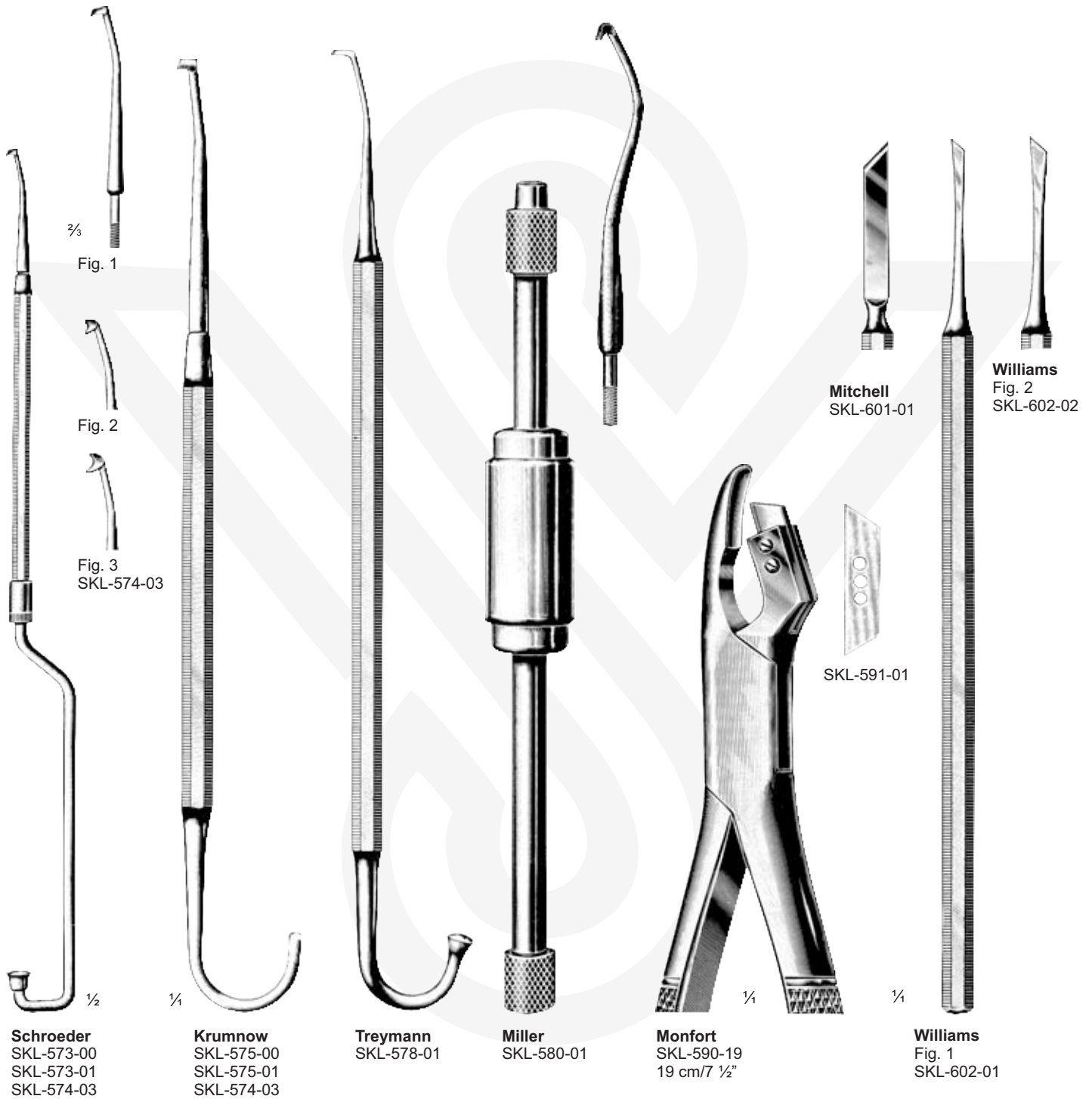
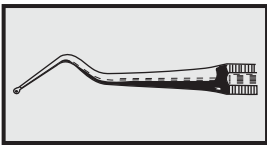

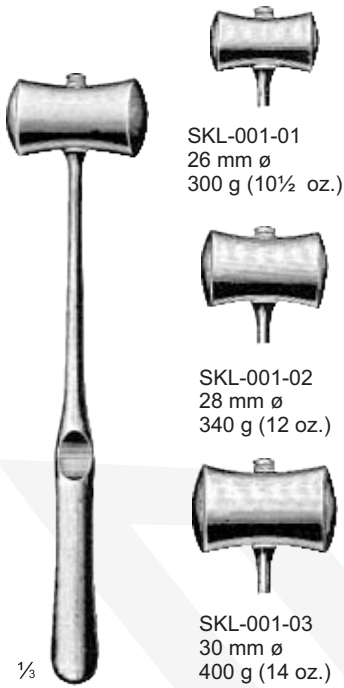
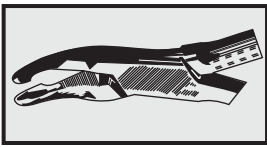

SKL-001-01
26 mm ø
300 g (10½ oz.)

SKL-001-02
28 mm ø
340 g (12 oz.)

SKL-001-03
30 mm ø
400 g (14 oz.)

Williger
24 cm / 9½"
lead filled

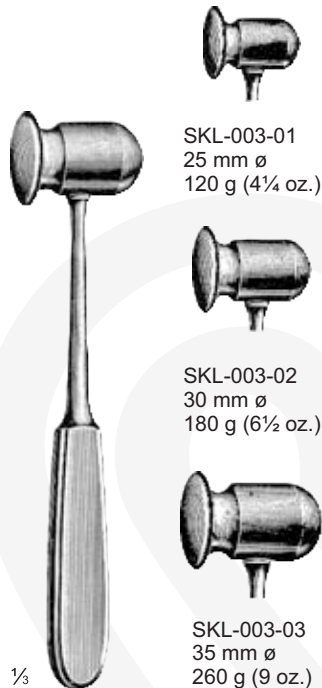

SKL-003-01
25 mm ø
120 g (4¼ oz.)

SKL-003-02
30 mm ø
180 g (6½ oz.)

SKL-003-03
35 mm ø
260 g (9 oz.)

Doyen
21 cm / 8¼"
brass, solid



30 mm ø
220 g
(7¾ oz.)

Collin
SKL-005-20
20 cm/8"
brass, solid



30 mm ø
510 g (18 oz.)

SKL-007-22
22.5 cm / 9"
steel, solid



26 mm ø
320 g (11¼ oz.)

Mead
SKL-009-17
17 cm / 6¾"
solid
SKL-009-00
Ferozell Cheeks
only, pair

with interchangeable
Ferozell Cheeks



20 mm ø
140 g
(5 oz.)

SKL-011-01
lead filled
SKL-011-02
brass, solid
16.5 cm / 6½"



Fig. 1
SKL-013-01
19 mm ø
230 g (8 oz.)

Fig. 2
SKL-013-02
25 mm ø
260 g (9 oz.)

Lucae
19 cm / 7½"
brass, solid



steel, solid,
with plastic handle

SKL-015-24
24 cm / 9½"

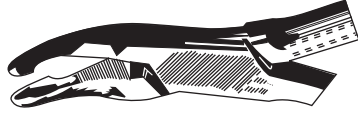

11

MALLETS, BONE ROUNGER & MOUTH GAGS



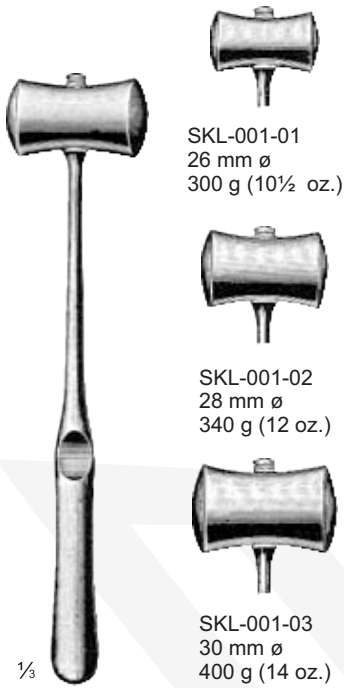
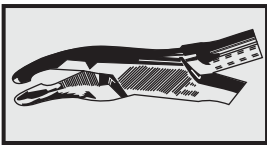

SKL-001-01
26 mm ø
300 g (10½ oz.)

SKL-001-02
28 mm ø
340 g (12 oz.)

SKL-001-03
30 mm ø
400 g (14 oz.)

Williger
24 cm / 9½"
lead filled

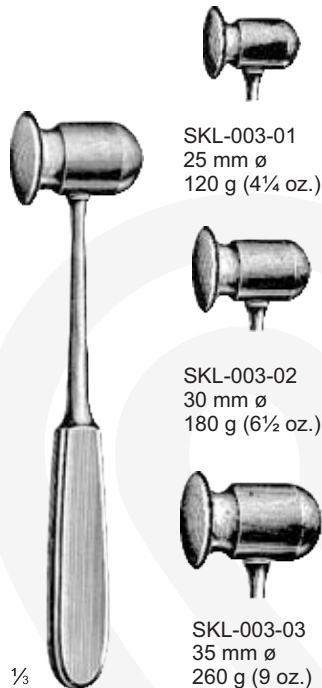

SKL-003-01
25 mm ø
120 g (4¼ oz.)

SKL-003-02
30 mm ø
180 g (6½ oz.)

SKL-003-03
35 mm ø
260 g (9 oz.)

Doyen
21 cm / 8¼"
brass, solid



30 mm ø
220 g
(7¾ oz.)

Collin
SKL-005-20
20 cm / 8"
brass, solid



30 mm ø
510 g (18 oz.)

SKL-007-22
22.5 cm / 9"
steel, solid



26 mm ø
320 g (11¼ oz.)

Mead
SKL-009-17
17 cm / 6¾"
solid
SKL-009-00
Ferozell Cheeks
only, pair

with interchangeable
Ferozell Cheeks



20 mm ø
140 g
(5 oz.)

SKL-011-01
lead filled
SKL-011-02
brass, solid
16.5 cm / 6½"



Fig. 1
SKL-013-01
19 mm ø
230 g (8 oz.)

Fig. 2
SKL-013-02
25 mm ø
260 g (9 oz.)

Lucae
19 cm / 7½"
brass, solid



steel, solid,
with plastic handle

SKL-015-24
24 cm / 9½"

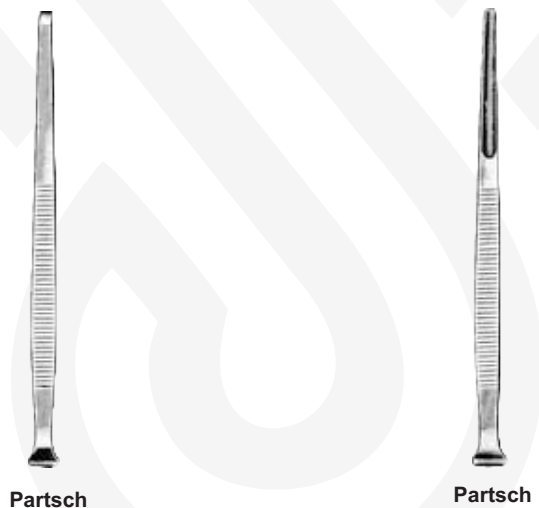
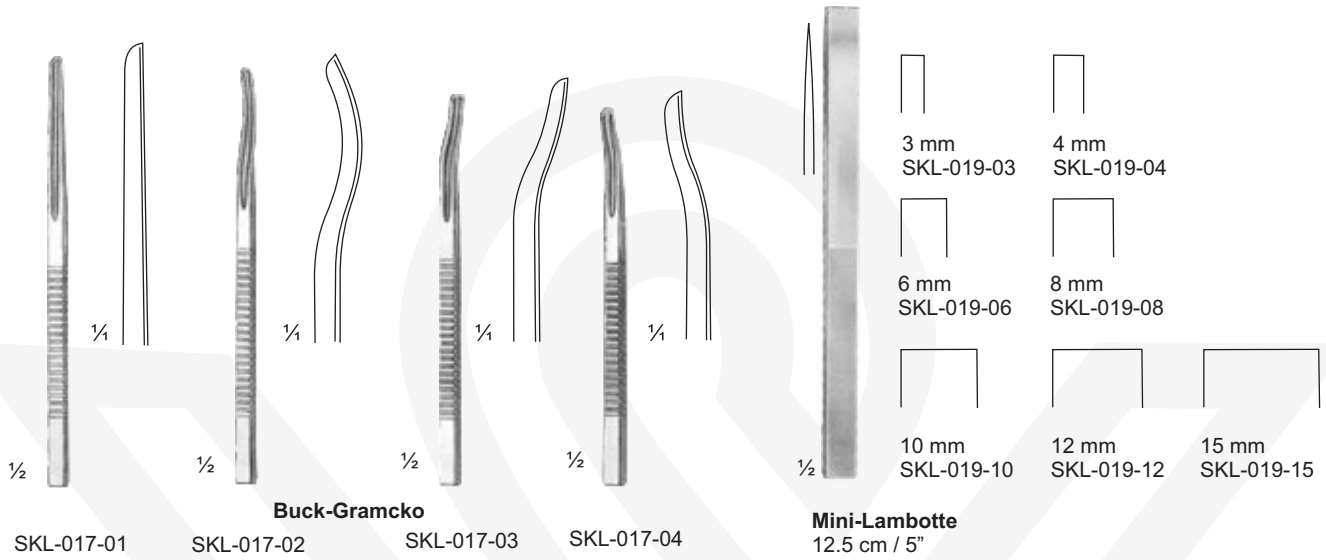
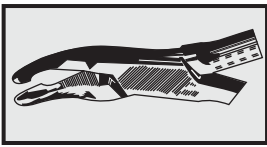

Partsch Partsch

		width		
		mm		
11.5 cm/4½"	13.5 cm/5¼"		11.5 cm/4½"	13.5 cm/5¼"
SKL-021-02	SKL-023-02	2	SKL-025-02	SKL-027-02
SKL-021-03	SKL-023-03	3	SKL-025-03	SKL-027-03
SKL-021-04	SKL-023-04	4	SKL-025-04	SKL-027-04
SKL-021-05	SKL-023-05	5	SKL-025-05	SKL-027-05
SKL-021-06	SKL-023-06	6	SKL-025-06	SKL-027-06
SKL-021-07	SKL-023-07	7	SKL-025-07	SKL-027-07
SKL-021-08	SKL-023-08	8	SKL-025-08	SKL-027-08

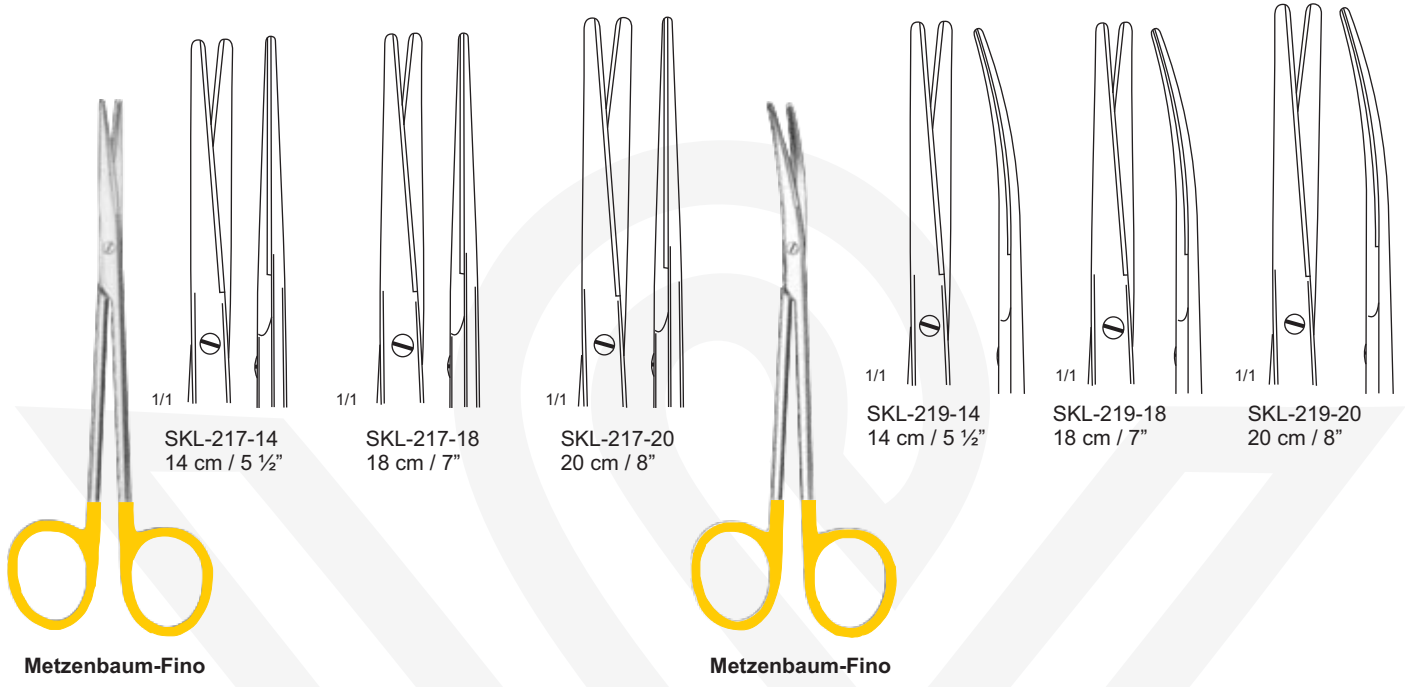

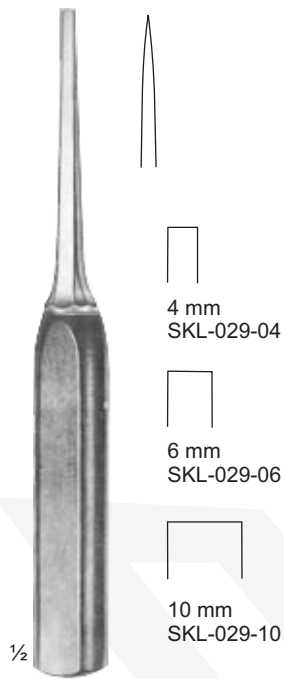
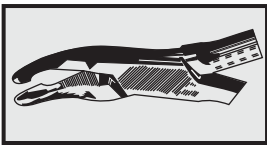

4 mm
SKL-029-04

6 mm
SKL-029-06

10 mm
SKL-029-10

Mini-Lexer
18 cm / 7"

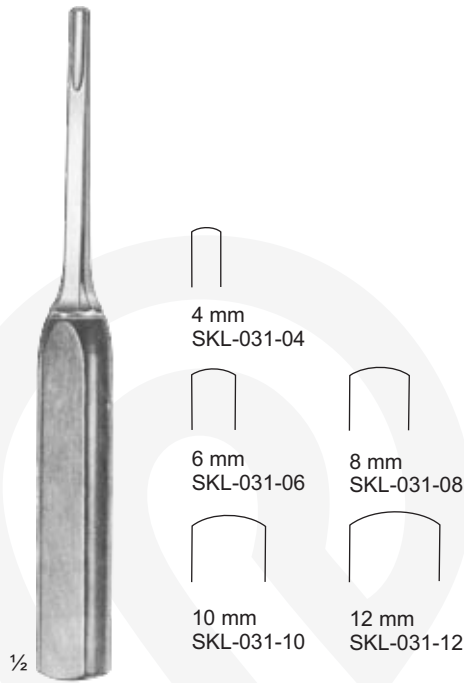

4 mm
SKL-031-04

6 mm
SKL-031-06

10 mm
SKL-031-10

Mini-Lexer
18 cm / 7"

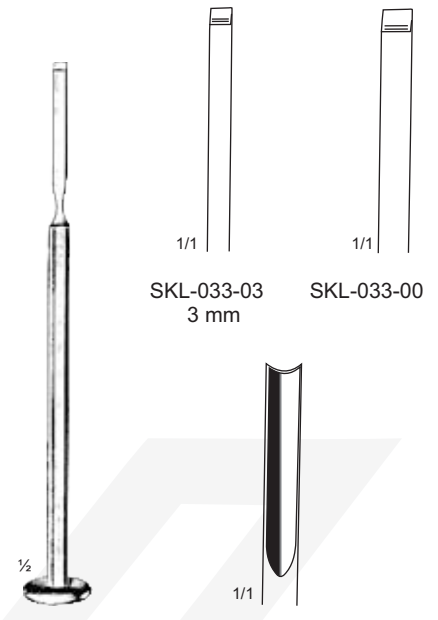

SKL-033-03
3 mm

SKL-033-00

Buckley
14 cm / 6 1/2"

SKL-033-04
4 mm

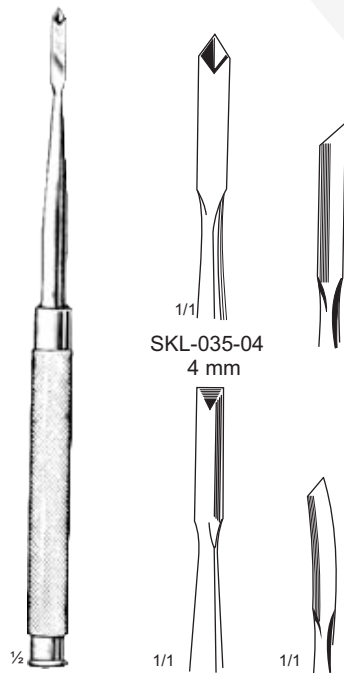

SKL-035-04
4 mm

Gardner
17.5 cm / 7"



SKL-039-01
4 mm

SKL-039-02
5 mm

SKL-039-03
6 mm

SKL-039-04
4 mm

SKL-039-05
4 mm

SKL-039-06
5 mm

SKL-039-07
5 mm

SKL-039-08
5 mm

Walter F. Barry
21.5 cm / 9"

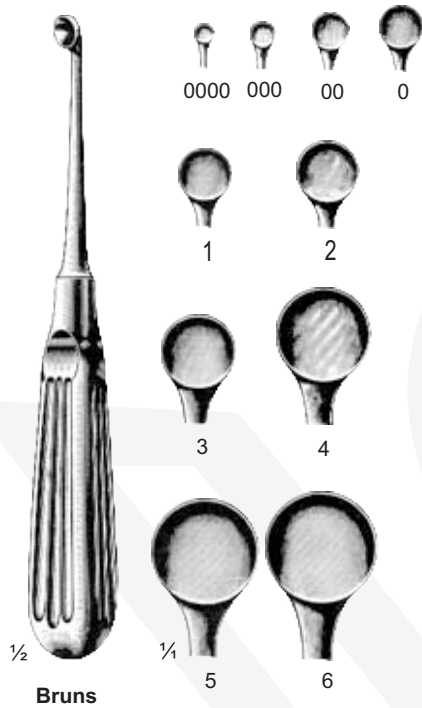
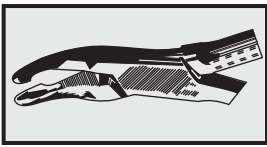

Brun's

- SKL-041-40
- SKL-041-30
- SKL-041-20
- SKL-041-10

- SKL-043-01
- SKL-043-02
- SKL-043-03

- SKL-043-04
- SKL-043-05
- SKL-043-06

Fig.

- 0000
- 000
- 00
- 0
- 1
- 2
- 3
- 4
- 5
- 6

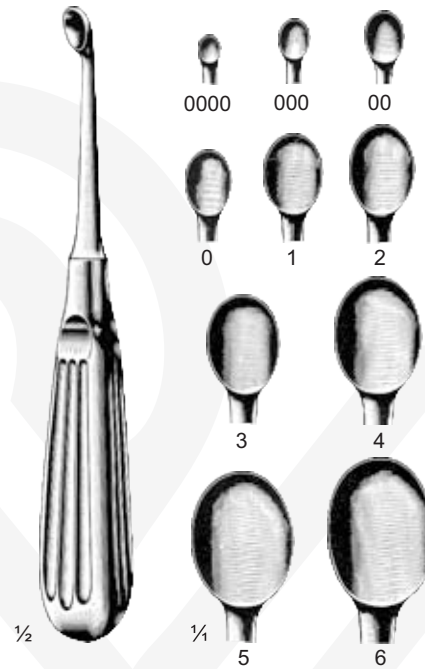
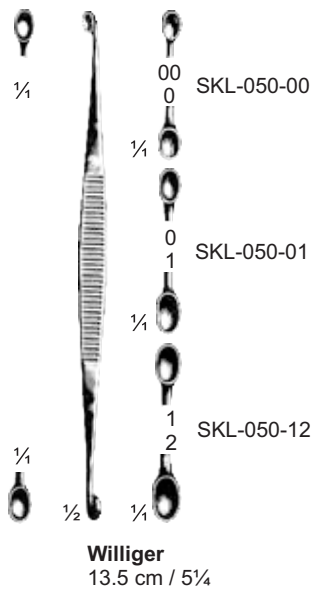
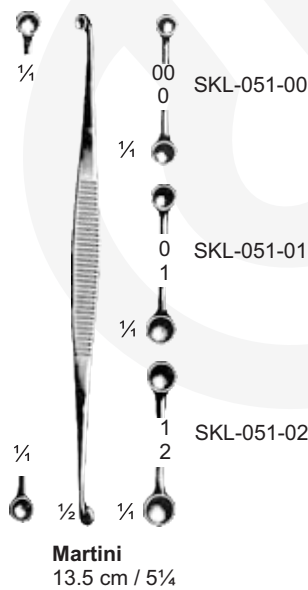

Fig. Volkmann

- 0000 SKL-045-40
- 000 SKL-045-30
- 00 SKL-045-20
- 0 SKL-047-10
- 1 SKL-047-01
- 2 SKL-047-02
- 3 SKL-049-03
- 4 SKL-049-04
- 5 SKL-049-05
- 6 SKL-049-06



Williger
13.5 cm / 5 1/4"



Martini
13.5 cm / 5 1/4"

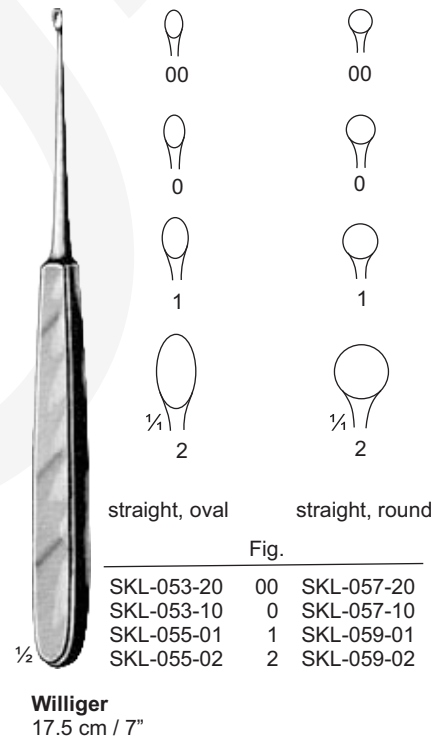

Williger
17.5 cm / 7"

- | | | |
|-----------------|----|------------|
| straight, oval | 00 | SKL-053-20 |
| | 0 | SKL-053-10 |
| | 1 | SKL-055-01 |
| | 2 | SKL-055-02 |
| straight, round | 00 | SKL-057-20 |
| | 0 | SKL-057-10 |
| | 1 | SKL-059-01 |
| | 2 | SKL-059-02 |

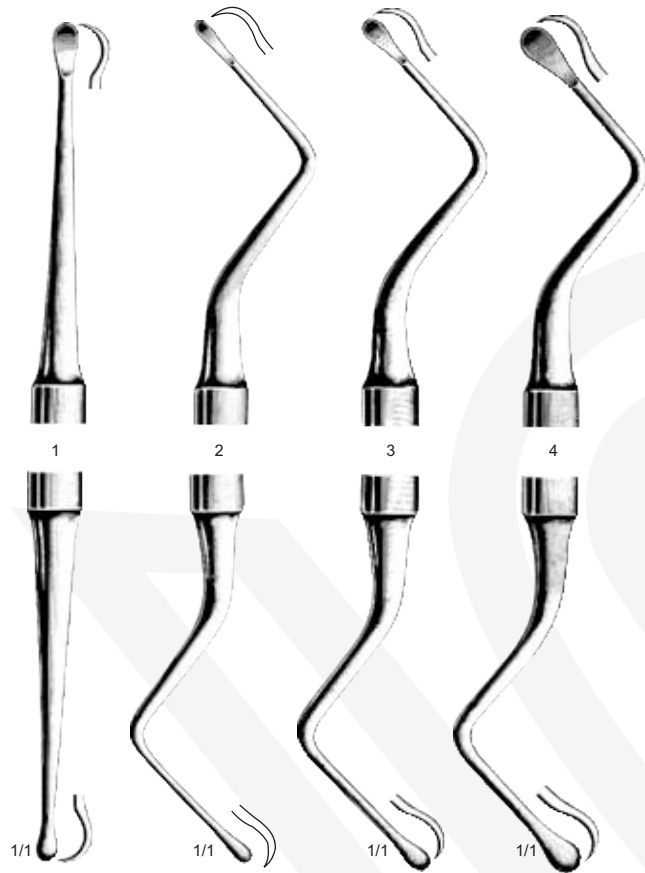
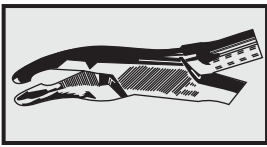

SKL-071-01 SKL-071-02 SKL-071-03 SKL-071-04

Miller-Colburn

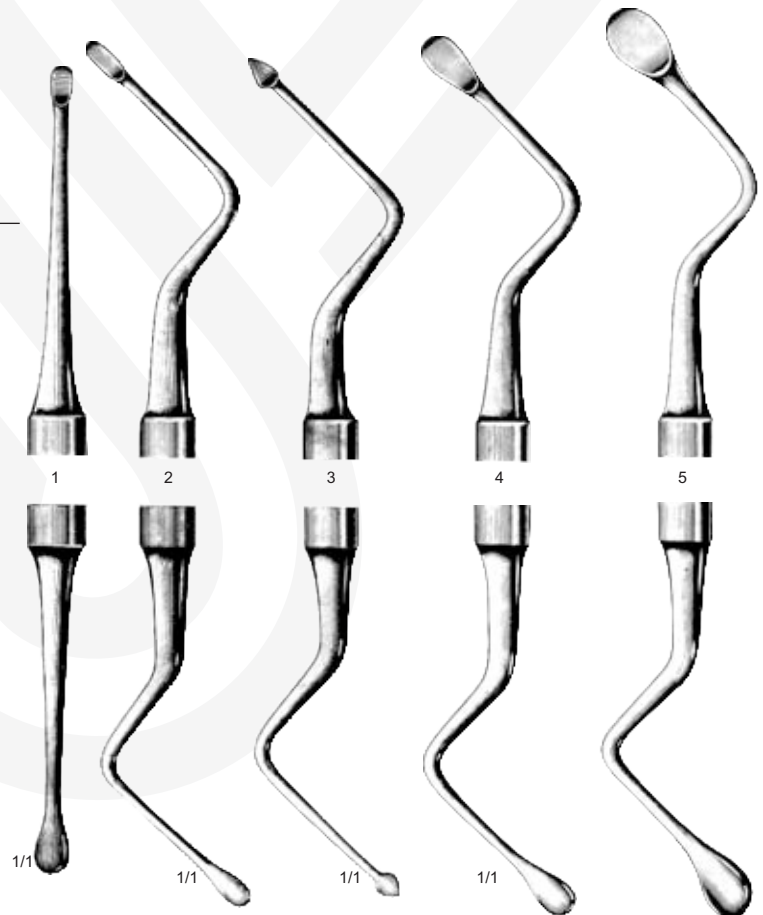

SKL-073-01 SKL-073-02 SKL-073-03 SKL-073-04 SKL-073-05

Mead

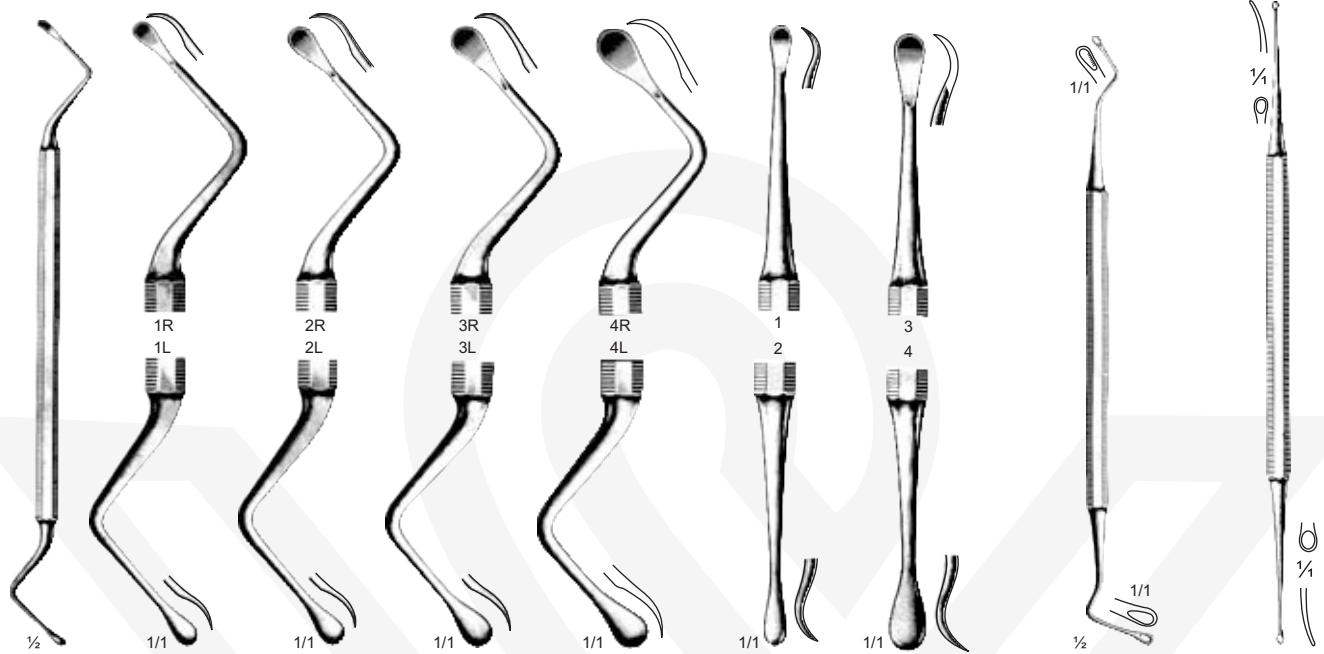
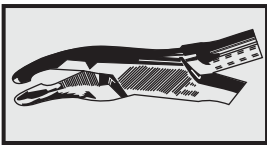

SKL-075-11 SKL-075-22 SKL-075-33 SKL-075-44 SKL-077-12 SKL-077-34 SKL-079-01 SKL-081-01

Lucas



SKL-083-01 SKL-083-02 SKL-083-03 SKL-083-04 SKL-083-05

Miller-Colburn

Williger
17 cm / 6 3/4"
SKL-085-17

Williger
16 cm / 6 1/4"
SKL-087-16

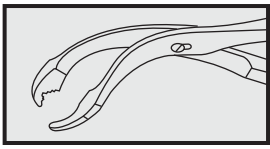

Seldin
SKL-089-01



Seldin
SKL-091-01



Seldin
SKL-093-01



SKL-095-01



SKL-095-02



SKL-095-03



SKL-095-04



SKL-095-05



SKL-095-06



SKL-095-07



Williger
13 cm / 5"
SKL-097-13



Williger
16 cm / 6¼"
SKL-099-16



West 2
19 cm / 7½"
SKL-101-19



Molt 9
19 cm / 7½"
SKL-103-19



Ohl
17 cm / 6¾"
SKL-105-17



Lederer
15 cm / 6"
SKL-107-15



Barr
17 cm / 6¾"
SKL-109-17

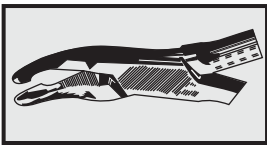

Frazier
13 cm / 5"
SKL-111-13



Kilner
SKL-113-15
15 cm/6"



Gillies
SKL-115-18
18 cm/7"



Knapp-Rollet
13 cm / 5"
SKL-117-02 (2 Teeth)
SKL-117-03 (3 Teeth)
SKL-117-04 (4 Teeth)

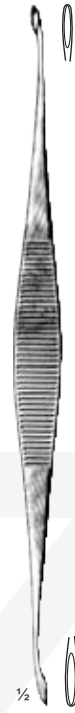

Barth
18 cm / 7"
SKL-119-18



Schwartz
11 cm / 4½"

Chisels	Width mm	Gouges
SKL-121-03	3	SKL-123-03
SKL-121-04	4	SKL-123-04
SKL-121-05	5	SKL-123-05
SKL-121-06	6	SKL-123-06
SKL-121-08	8	SKL-123-08
SKL-121-10	10	SKL-123-10



Schwartz
11 cm / 4½"



Fischer
15 cm / 5"



4 mm
SKL-125-04

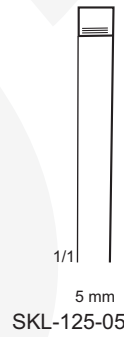

5 mm
SKL-125-05

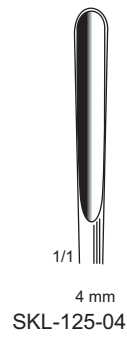

4 mm
SKL-125-04



5 mm
SKL-125-05



9 mm
SKL-125-09

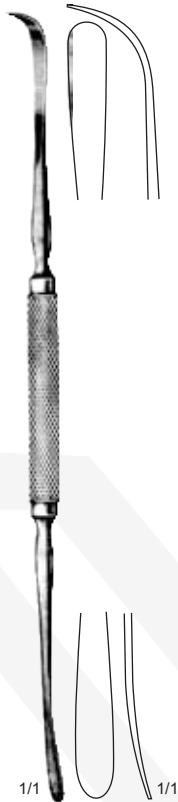
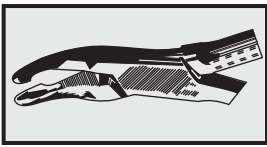

Freer
20 cm / 8"
SKL-129-20



Freer
16 cm / 6 1/4"
SKL-131-16
4 mm



Killian
16 cm / 6 1/4"
SKL-133-16



Hajeki-Calus
SKL-135-20 mm

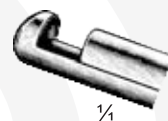

Kerrison
SKL-137-17
SKL-137-05 mm
SKL-137-06 mm
SKL-137-07 mm

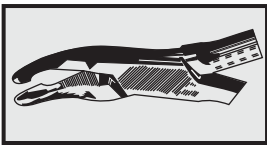

15 cm / 6"
SKL-153-15



Cleveland-Gardener
16 cm / 6¼"
SKL-155-16



Cleveland-Gardener
16 cm / 6¼"
SKL-157-16



18 cm / 7"
SKL-159-18



Luer
SKL-161-15
15 cm/6"



Luer
SKL-163-15
15 cm/6"



SKKYLINE



3

Dressing Forceps



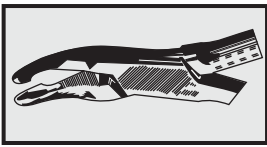

Blumenthal
15.5 cm/6"
SKL-165-15



Blumenthal
15.5 cm/6"
SKL-167-15



Blumenthal
15.5 cm/6"
SKL-169-15



Hartmann
18.5 cm / 7 1/4"
SKL-171-18



Mead
16.5 cm/6 1/2"
SKL-173-16

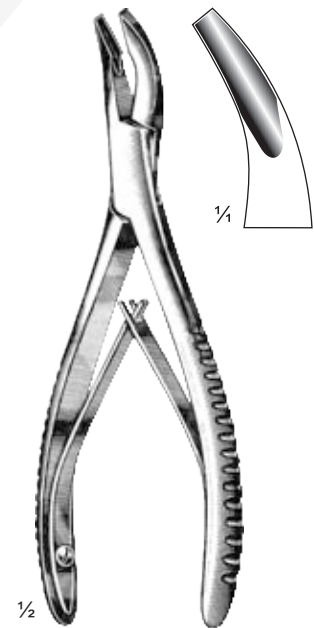

Mead
16.5 cm/6 1/2"
SKL-175-16

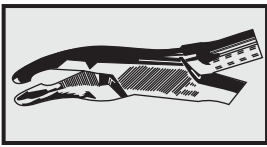

1/2

Heister
13 cm/5"
SKL-177-13



1/2

Doyen-Jansen (Molt)
12 cm/4 3/4"
SKL-179-12 Child



1/2

Doyen-Jansen (Molt)
14 cm/5 1/2"
SKL-181-14 Adult



1/2

Denhart
12 cm/4 3/4"
SKL-183-12



1/2

Rosier-Koeing

cm	in	
16	6 1/4	SKL-185-16
19	7 1/2	SKL-185-19



Jenning

cm	in	
09	3 1/2	SKL-189-09
11	4 1/4	SKL-189-11
13	5	SKL-189-13
15	6	SKL-189-15



Whitehead

cm	in	
11	4 1/4	SKL-191-11
13	5	SKL-191-13
15	6	SKL-191-15

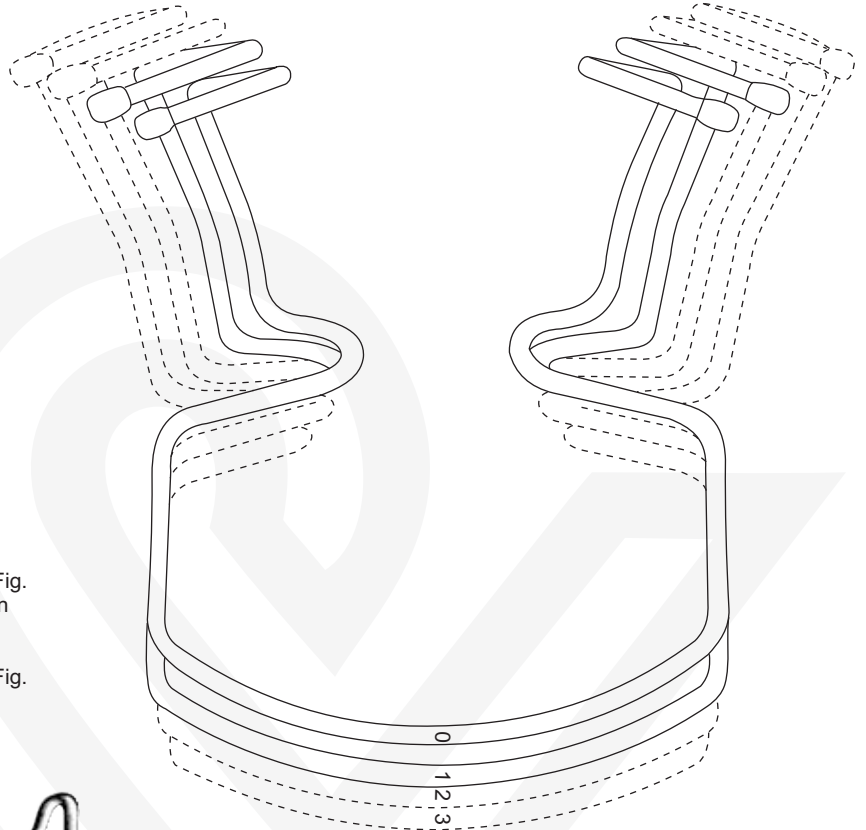
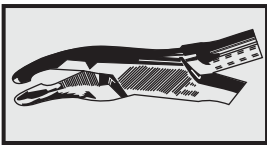

SKL-193-00 Fig. 0, For children
 SKL-193-01
 SKL-193-02
 SKL-193-03 Fig. 1-2-3 Set
 SKL-193-13



1/2
 11 cm/4 1/4"
 SKL-194-11



1/2



1/2

Sternberg

	cm	in	
SKL-195-12	12	4 3/4	SKL-197-12
SKL-195-14	14	5 1/2	SKL-197-14
SKL-195-16	16	6 1/4	SKL-197-16



1/2

19 cm/7 1/2"
 SKL-203-19

SKL-199-12	SKL-201-11	Cheek Retractor
SKL-199-14	SKL-201-12	Lip Retractor
SKL-199-16	SKL-201-14	Lip Retractor
SKL-199-18	SKL-201-16	Lip Retractor
SKL-199-21	SKL-201-18	Lip Retractor
	SKL-201-19	Cheek Retractors

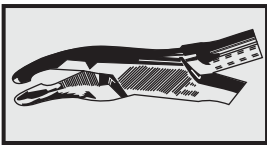

1/2

Hartmann
15 cm/6"
SKL-205-15



1/2

Tobold
14.5 cm / 5 1/2"
SKL-207-14



1/2

Tobold
14.5 cm/5 3/4"
SKL-209-14



1/2

Andrew
11 cm/4 1/4"
SKL-211-11



1/2

Wieder



1/2

14 cm/5 1/2"
SKL-213-14
Fig. 01



1/2

15 cm/6"
SKL-213-15
Fig. 02

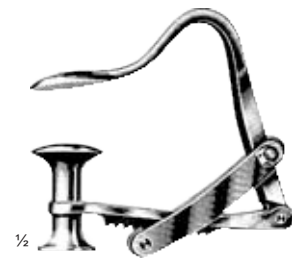

1/2

Rottenstein-Schreite
SKL-215-00

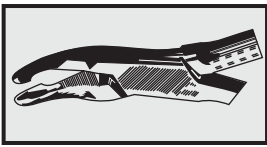

1/2

Doyen

cm in.

13	5	SKL-217-13
16	6 1/4	SKL-217-16



SKL-219-00
SKL-219-00

1/2



Zuwafix
SKL-221-00



1/2

Hartmann
SKL-223-15
15 cm/6"



1/2

Andrew
SKL-229-11
11 cm/4 1/4"

1/2

Tobold
SKL-227-14
14.5 cm/5 3/4"

1/2

Tobold
14.5 cm / 5 1/2"
SKL-225-14

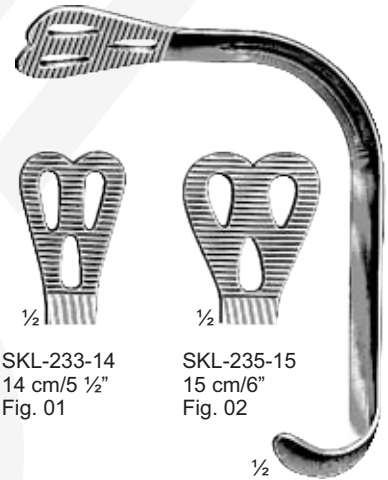

1/2

SKL-233-14
14 cm/5 1/2"
Fig. 01

1/2

SKL-235-15
15 cm/6"
Fig. 02

1/2

Wieder



1/2

Rottenstein-Schreite
SKL-231-00

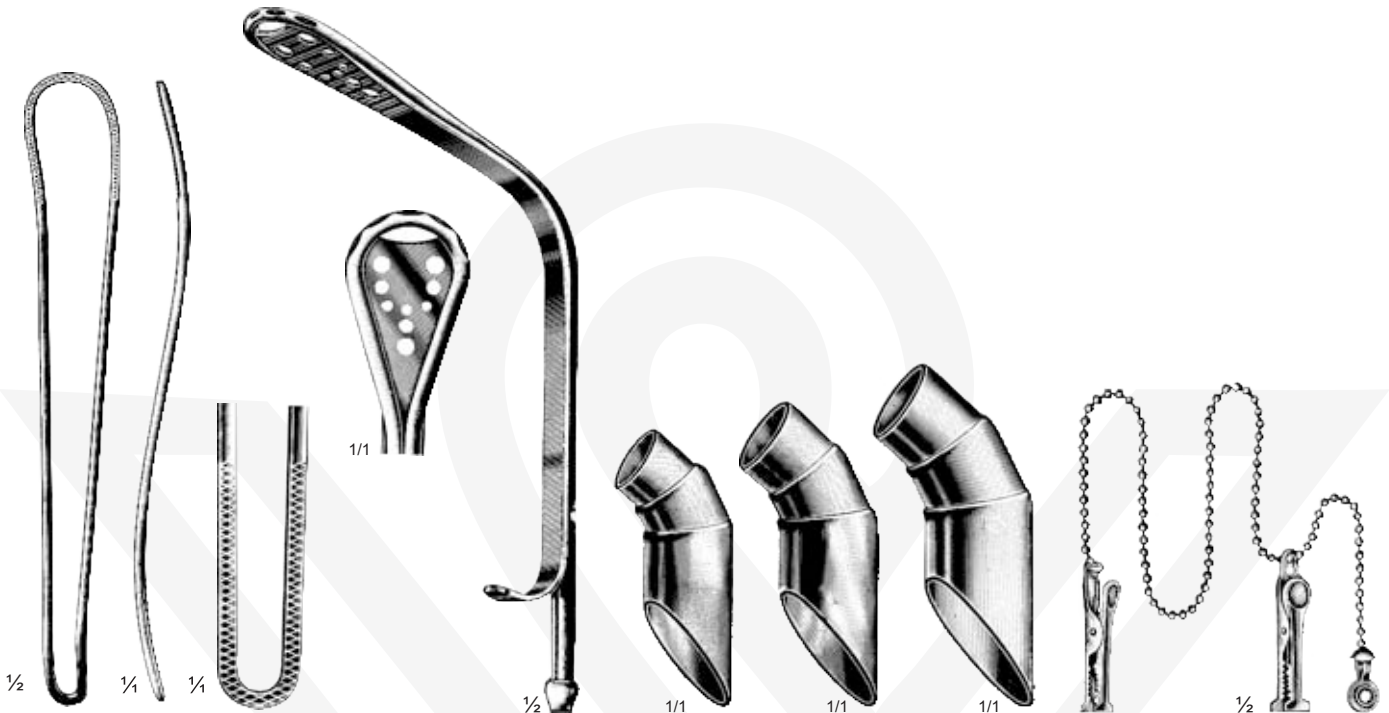
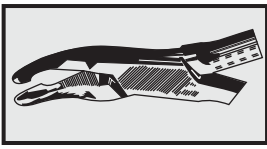

Frenzel
SKL-237-16
16.5 cm/6"

Le Mee
SKL-239-01

SKL-241-01

Langenbeck

SKL-243-02

SKL-245-03

SKL-247-01



Adams
SKL-249-01

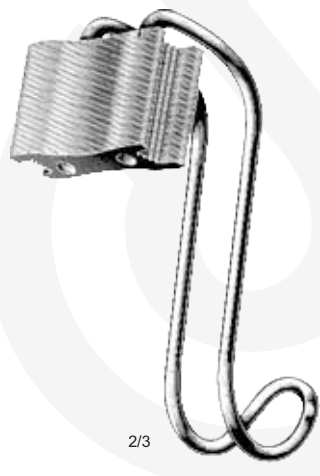

Pitha
SKL-251-00

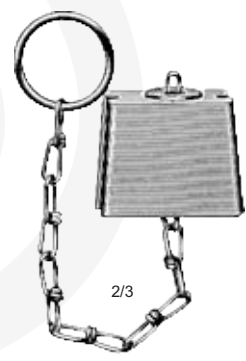

Pitha
SKL-253-00



Baisch
SKL-255-00

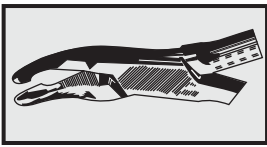

Collin

cm	in	
16	6 ¼	SKL-257-16
18	7	SKL-257-18

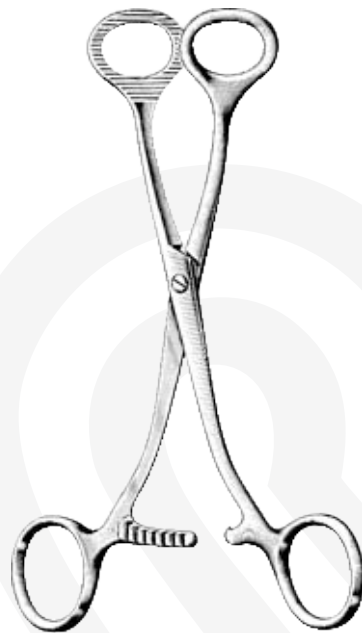

Collin
 SKL-259-17
 17 cm / 6¾"



Young
 16 cm / 6 ¼"
 SKL-261-16



Hartmann
 SKL-263-01
 For children / Women



Hartmann
 SKL-265-01
 Regular Size



Hartmann
 SKL-267-01

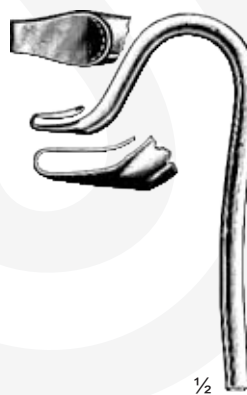

Fluofix



SKL-269-01

SKL-269-02

SKL-269-03

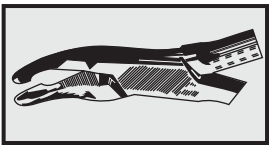

Luniatschek
18.5 cm / 7 1/4"
SKL-271-18



Luniatschek
17 cm / 6 3/4"
SKL-273-17



Claus
23 cm / 9"
SKL-275-23



Durham
25 cm / 10"
SKL-277-25



Durham
25 cm / 10"
SKL-279-25

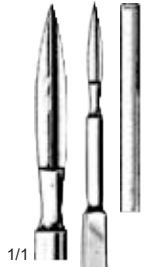
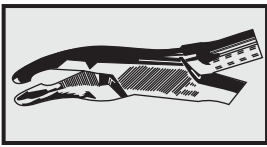

17 cm / 7"
SKL-281-17



Brophy
19 cm / 7½"
SKL-283-19



Whitehead
19 cm / 7½"
SKL-285-19



Whitehead
19 cm / 7½"
SKL-287-19

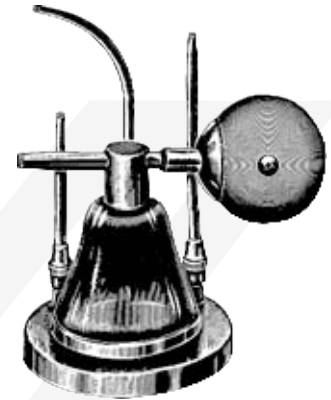

Kabierske
SKL-289-00



8 cm / 3¼"
SKL-291-08

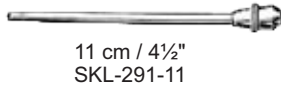

11 cm / 4½"
SKL-291-11

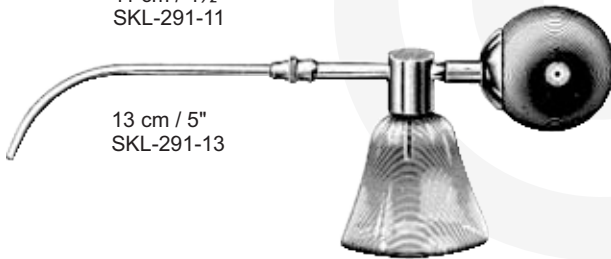

13 cm / 5"
SKL-291-13

Kabierske
SKL-291-00

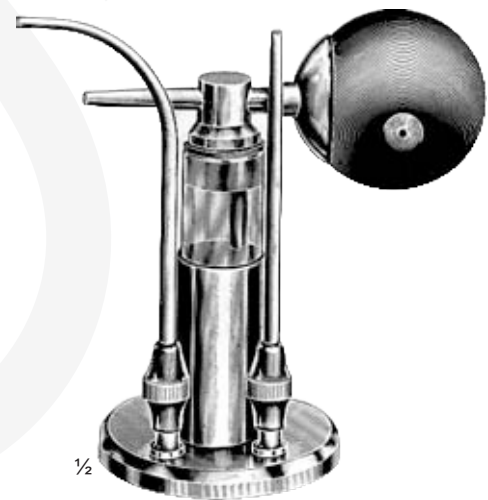

Halle-Hebderich
SKL-293-00

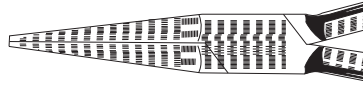

Pliers







cm	in.	Standard	Standard	Standard	Standard	USA. Mod.	USA. Mod.
10.5	4¼	SKL-001-10	SKL-003-10	SKL-005-10	SKL-007-10		
14.5	5½	SKL-001-14	SKL-003-14	SKL-005-14	SKL-007-14	SKL-009-14	SKL-011-14
16	6½	SKL-001-16	SKL-003-16	SKL-005-16	SKL-007-16		
18	7	SKL-001-18	SKL-003-18	SKL-005-18	SKL-007-18	SKL-009-18	SKL-011-18

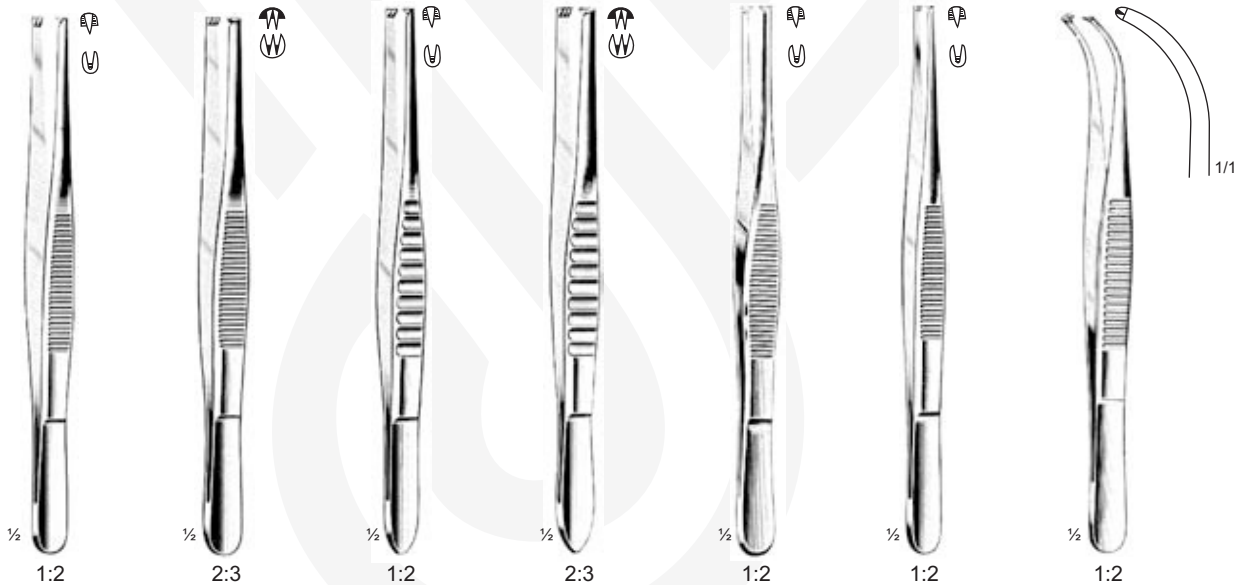

cm	in.							
11	4½	SKL-013-11	SKL-015-11					
14	6	SKL-013-14	SKL-015-14	SKL-017-14	SKL-019-14	SKL-021-14	SKL-023-14	SKL-025-14
16	7	SKL-013-16	SKL-015-16					
18	8	SKL-013-18	SKL-015-18	SKL-017-18	SKL-019-18			

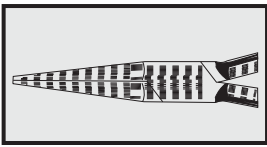

Lodo
15 cm \ 6"
SKL-001-15
Pliers for Removing
Bridges and Crowns.



Furrer
15 cm \ 6"
SKL-003-15
Copper Ring Removing Pliers



Weingart
14 cm \ 5½"
SKL-005-14
Wire Seizing and
Ligature Pliers

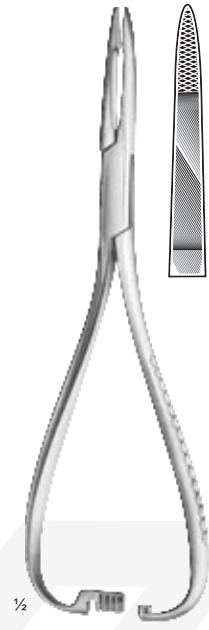

15 cm \ 6"
SKL-007-15
Wire Seizing and
Ligature Pliers

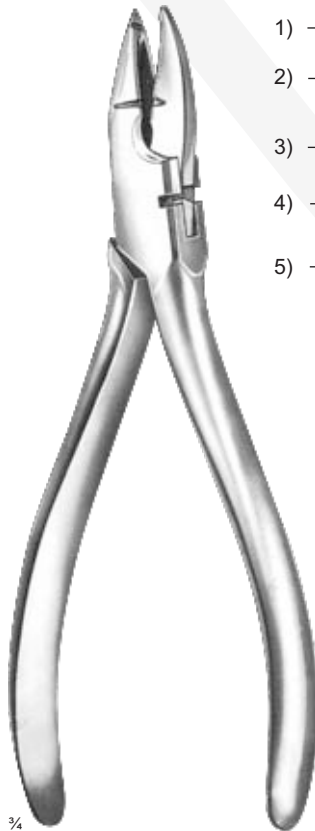

Waldsachs-Universal
15.5 cm \ 6"
SKL-009-15
Universal Pliers

- 1) →
- 2) →
- 3) →
- 4) →
- 5) →



- to be used as:
- 1) Pin and Ligature Pliers
 - 2-3) Clasp Bending Pliers
 - 4) Bar Bending Pliers
 - 5) Cutting Pliers



Universal
15.5 cm \ 6"
SKL-011-15 Universal
Pin Roughening, Cutting and
Bending Forceps



Universal
15.5 cm \ 6"
SKL-011-15

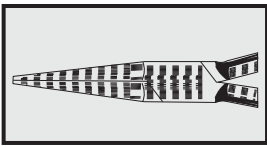

McKellops
16 cm \ 6¼"
SKL-013-16

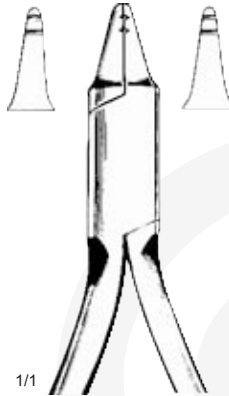

Oliver
12.5 cm \ 5"
SKL-015-12



McKellops
17 cm \ 6¾"
SKL-017-17



Waldron
12.5 cm \ 5"
SKL-019-12



Stadler
15 cm \ 6"
SKL-021-15



SKL-023-14
Smooth



SKL-024-14
Serrated

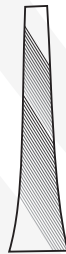

SKL-027-14
Smooth



SKL-029-14
Serrated

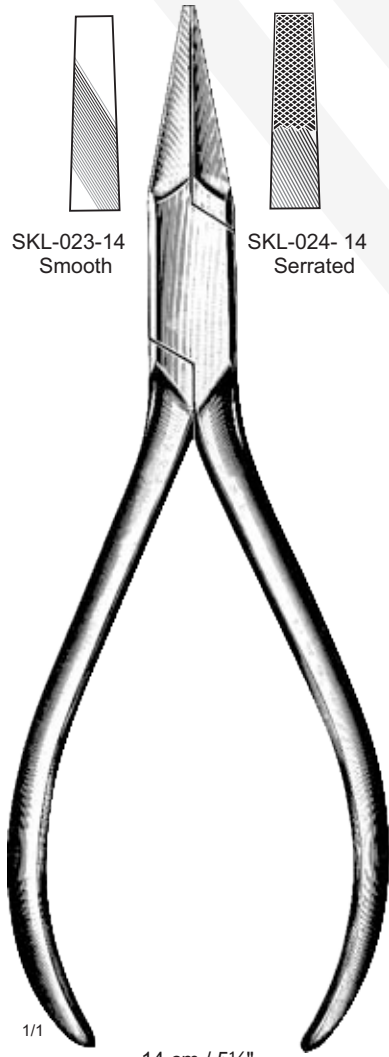

14 cm / 5½"

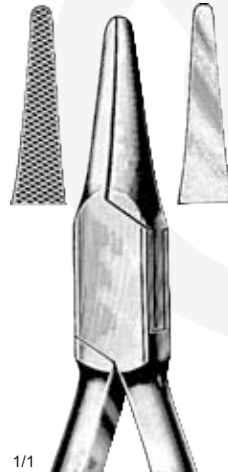

Goslee
14 cm / 5½"
SKL-025-14

Langenbeck
14 cm / 5½"



12.5 cm / 5"



SKL-031-12
Smooth



SKL-033-12
Serrated

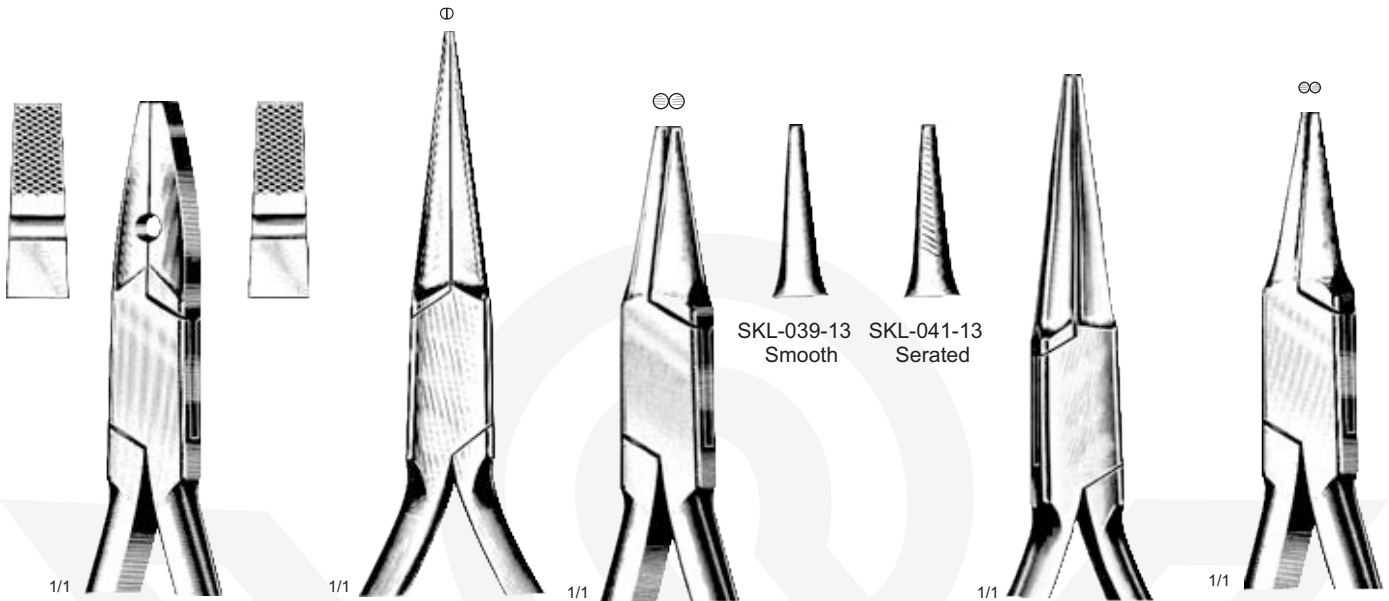
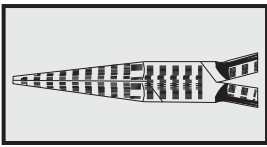

14 cm / 5½"
SKL-035-14

Langenbeck
14 cm / 5½"
SKL-037-14

13 cm / 5"

SKL-039-13 Smooth
SKL-041-13 Serated

Langenbeck
14 cm / 5½"
SKL-043-14

13 cm / 5"
SKL-045-13

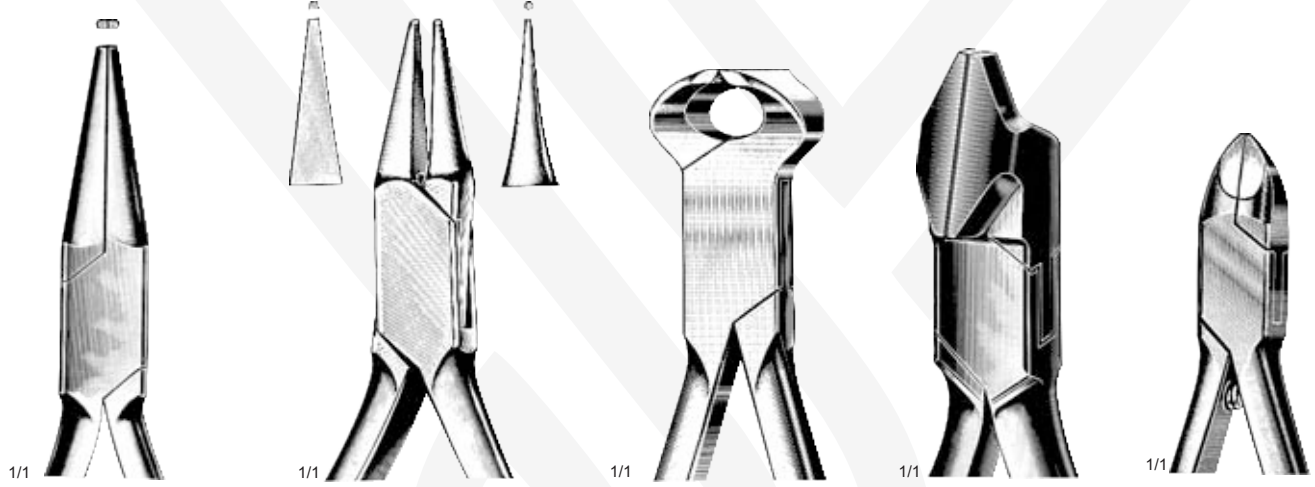

13 cm / 5"
SKL-047-13

15 cm / 6"
SKL-049-15

12.5 cm / 5"
SKL-051-12

13 cm / 5"
SKL-053-13

11 cm / 4½"
SKL-055-11

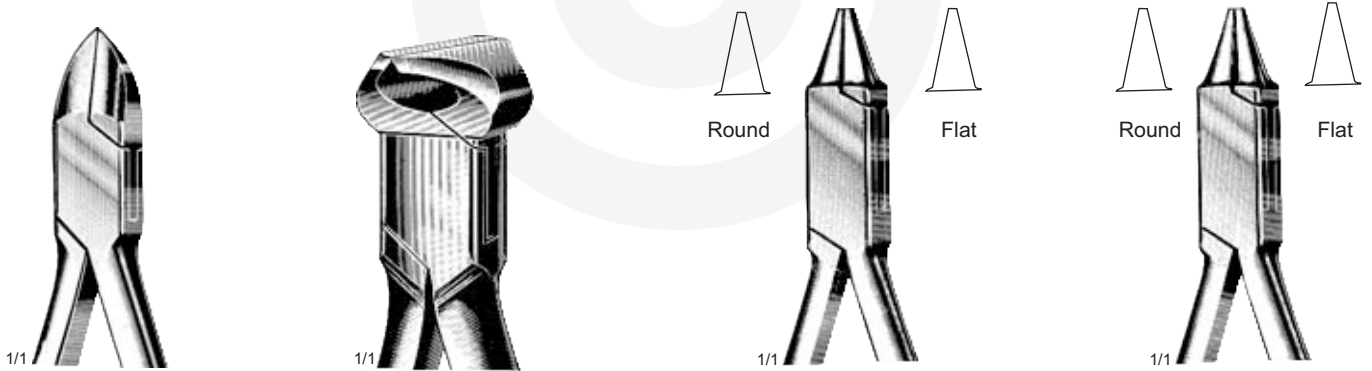

11 cm / 4½"
SKL-057-11

12 cm / 4½"
SKL-059-12

Angle
12 cm / 4¾"
SKL-061-12

12 cm / 4¾"
SKL-063-12

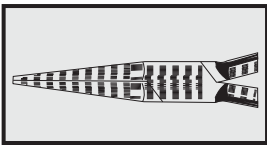

1/1

Dumont
11.5 cm / 4½"

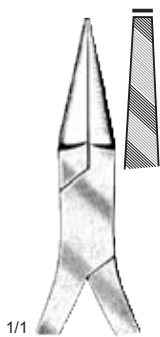

1/1

SKL-065-11

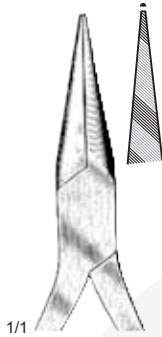

1/1

SKL-067-11



1/1

SKL-069-11



1/1

Dumont
11.5 cm / 4½"



1/1

SKL-071-11



1/1

SKL-073-11

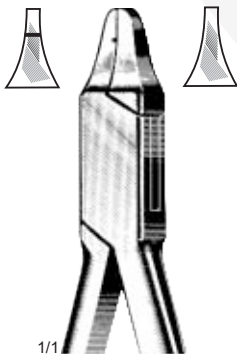

1/1

Angle
13 cm / 5"
SKL-075-13



1/1

Angle
13 cm / 5"
SKL-077-13



1/1

Adams
13 cm / 5"
SKL-079-13



1/1

Aderer
13 cm / 5"
SKL-081-13

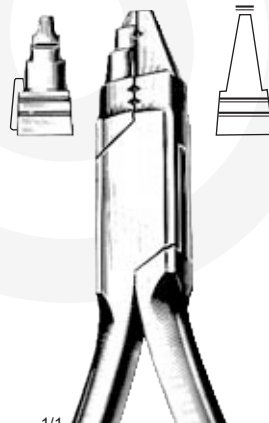

1/1

Young
13 cm / 5"
SKL-083-13



1/1

Aderer
14 cm / 5½"
SKL-085-14

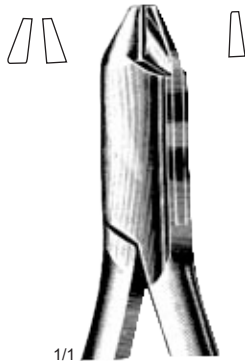
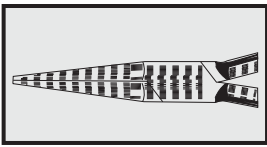

1/1
Aderer
11.5 cm / 4½"
SKL-087-11

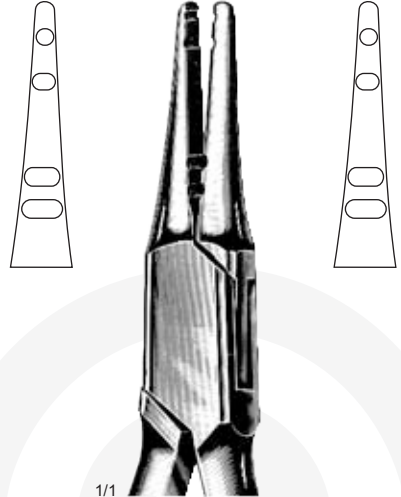

1/1
Aderer
14 cm / 5½"
SKL-089-14

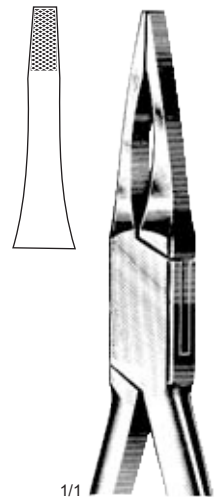

1/1
Fischer
13.5 cm / 5¼"
SKL-091-13



1/1
Diamant
16 cm / 6¼"
SKL-093-16

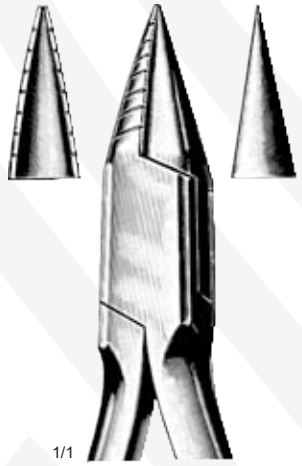

1/1
Schwarz
14.5 cm / 5¾"
SKL-094-14



1/1
Fischer
14 cm / 5½"
SKL-095-14

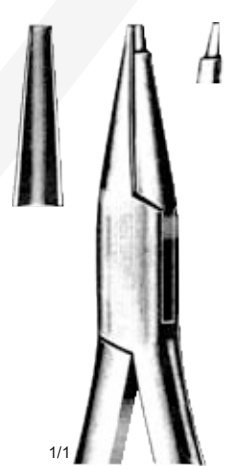

1/1
Andresen
14 cm / 5½"
SKL-097-14



1/1
Schwarz
13 cm / 5"
SKL-099-13



1/1
Schwarz
13 cm / 5"
SKL-101-13



1/1
Schwarz
13 cm / 5"
SKL-103-13

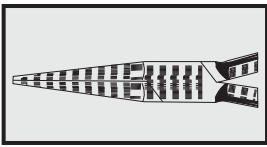

1/1

Tryfus
16.5 cm / 6½"
SKL-105-16



1/1

Peeso
14.5 cm / 5¾"
SKL-107-14

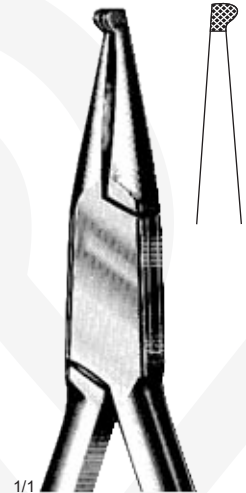

1/1

How
14 cm / 5½"
SKL-109-14

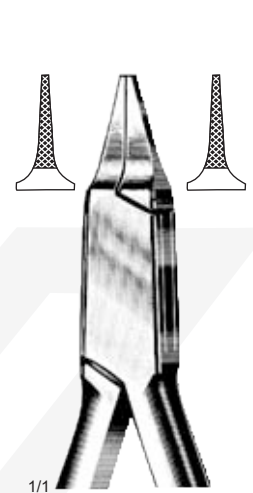

1/1

Frevert
12 cm / 4¾"
SKL-111-12



1/1

Johnson
13 cm / 5"
SKL-113-13

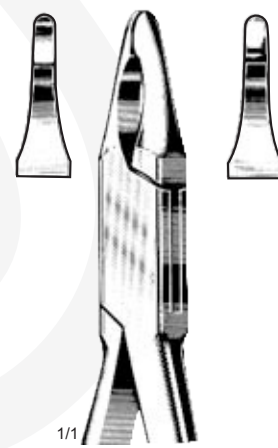

1/1

Johnson
13 cm / 5"
SKL-115-13

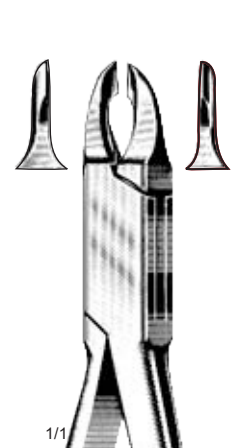

1/1

Angle
13 cm / 5"
SKL-117-13

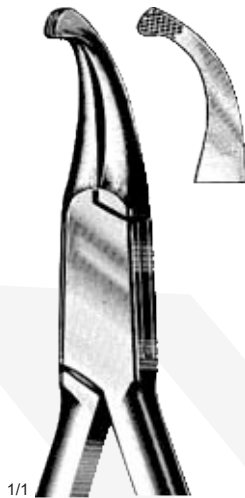
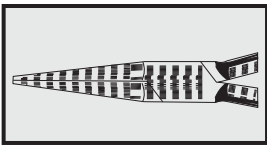

1/1
How
14 cm / 5½"
SKL-119-14



1/1
Ziebe
13 cm / 5"
SKL-121-13

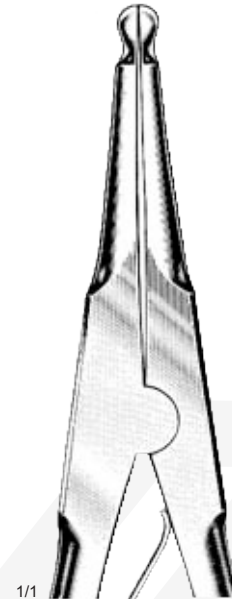

1/1
Herbst
14 cm / 5½"
SKL-123-14

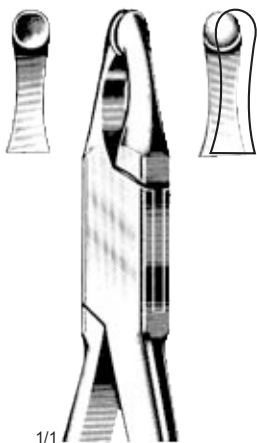

1/1
Abell
13 cm / 5"
SKL-125-13

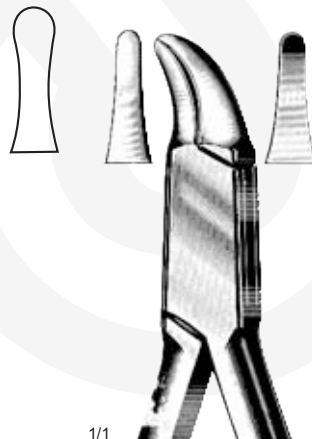

1/1
Reynolds
12.5 cm / 5"
SKL-127-12

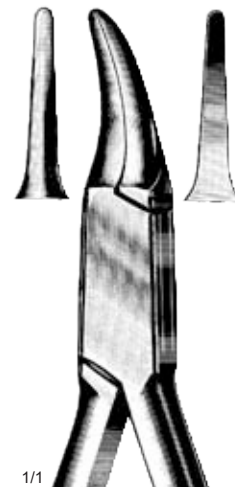

1/1
Gordon
14 cm / 5½"
SKL-129-14

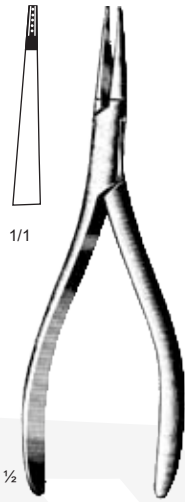
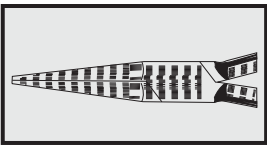

13 cm / 5"
SKL-131-13

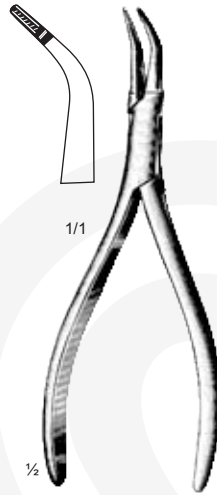

13 cm / 5"
SKL-133-13



16 cm / 6 1/4"
SKL-135-16

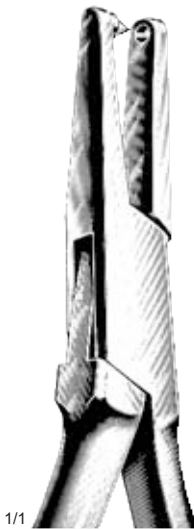

Ainworth
16 cm / 6 1/4"
SKL-137-16



Tuttle
15 cm / 6"
SKL-139-15

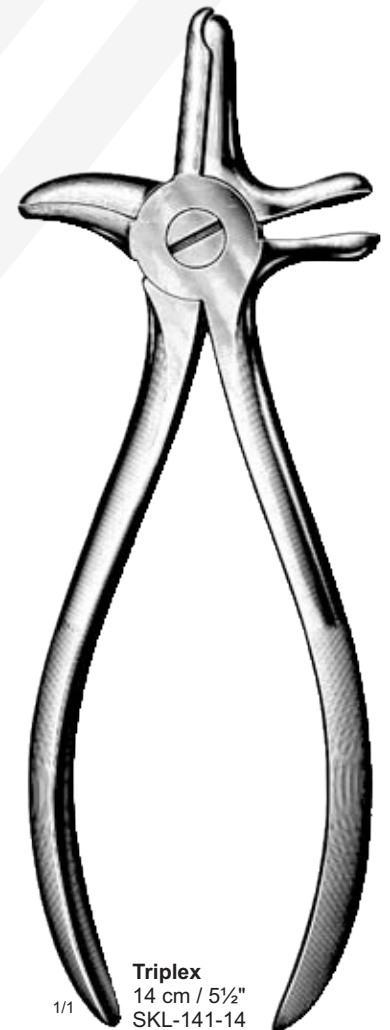

Triplex
14 cm / 5 1/2"
SKL-141-14

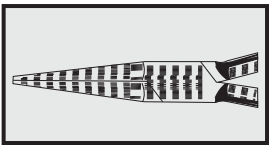

1/2

16 cm/6 1/4" SKL-157-16
18 cm/7" SKL-159-18
23 cm/9" SKL-161-23



14 cm/5 1/2" SKL-163-14



15 cm/6" SKL-165-15



13 cm/5" SKL-167-13



13 cm/5 1/2" SKL-169-13



13 cm/5 1/2" SKL-171-13
Angled at 15°, with or without
spring on the handles.



13 cm/5 1/2" SKL-173-13



13 cm/5 1/2" SKL-175-13



13 cm/5 1/2" SKL-177-13
Angled at 15°



13 cm/5 1/2" SKL-179-13
Angled at 15°

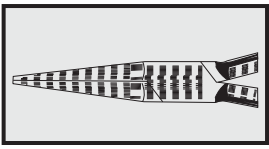

13 cm/5 1/2"
SKL-181-13



13 cm/5 1/2"
DC36183-13



15 cm/6"
SKL-185-15
Hard wire 0.55x0.64
Long handle



13 cm/5 1/2"
SKL-187-13



13 cm/5 1/2"
SKL-189-13

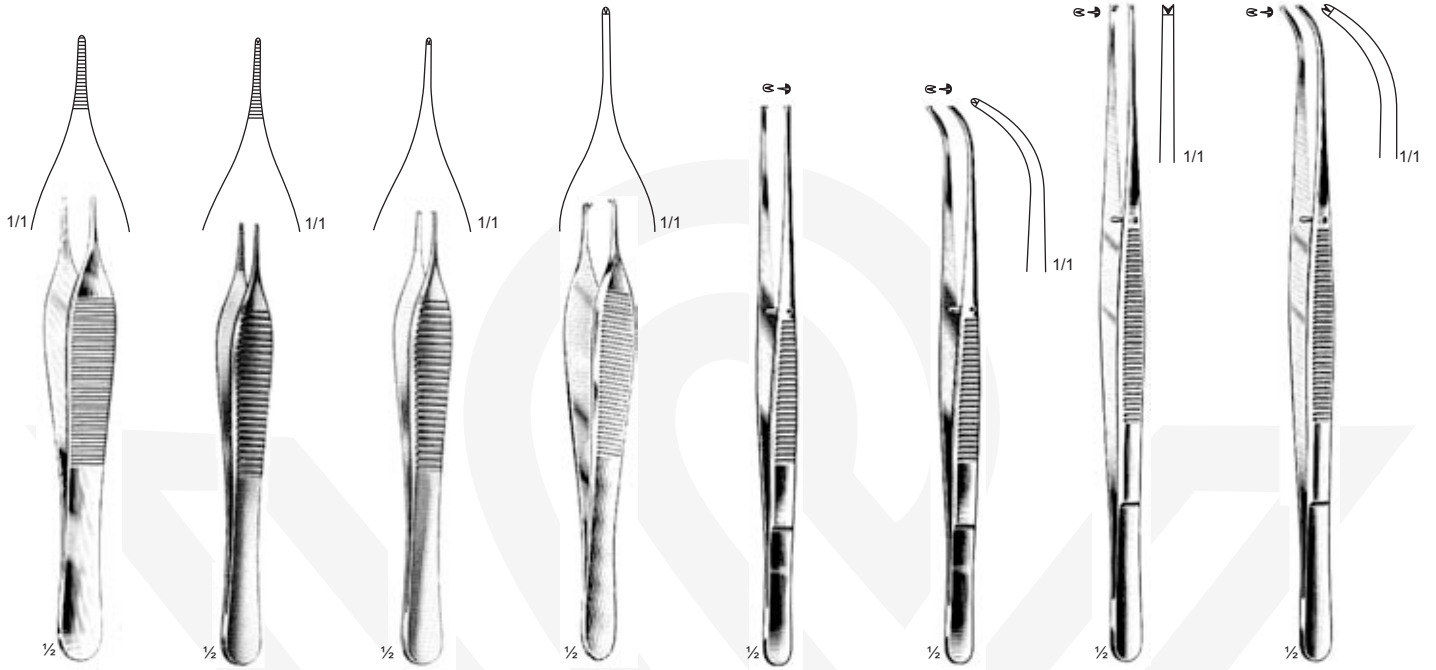

Adson
12 cm / 4¾"
SKL-026-12

Micro-Adson
12 cm / 4¾"
SKL-027-12

Micro-Adson
12 cm / 4¾"
SKL-029-12
1:2

Adson
12 cm / 4¾"
SKL-031-12
15 cm / 6"
SKL-031-15
1:2

Semken
12.5 cm / 5"
SKL-033-12
15 cm / 6"
SKL-033-15
1:2

Semken
12.5 cm / 5"
SKL-035-12
15 cm / 6"
SKL-035-15
1:2

Taylor
17.5 cm / 7"
SKL-037-17
1:2

Taylor
17.5 cm / 7"
SKL-039-17
1:2



Taylor
17.5 cm / 7"
SKL-041-17
1:2

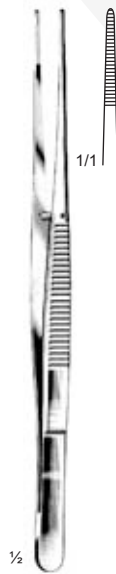

Semken
12.5 cm / 5"
SKL-043-12
15.5 cm / 6"
SKL-043-15



Semken
12.5 cm / 5"
SKL-045-12
15.5 cm / 6"
SKL-045-15



Potts-smith
18 cm / 7"
SKL-047-18
21 cm / 8¼"
SKL-047-21



Potts-smith
18 cm / 7"
SKL-049-18
21 cm / 8¼"
SKL-049-21



Adson-Brown
12 cm / 4¾"
SKL-051-12

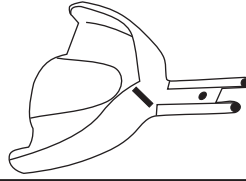

13

Articulators & Impression Trays

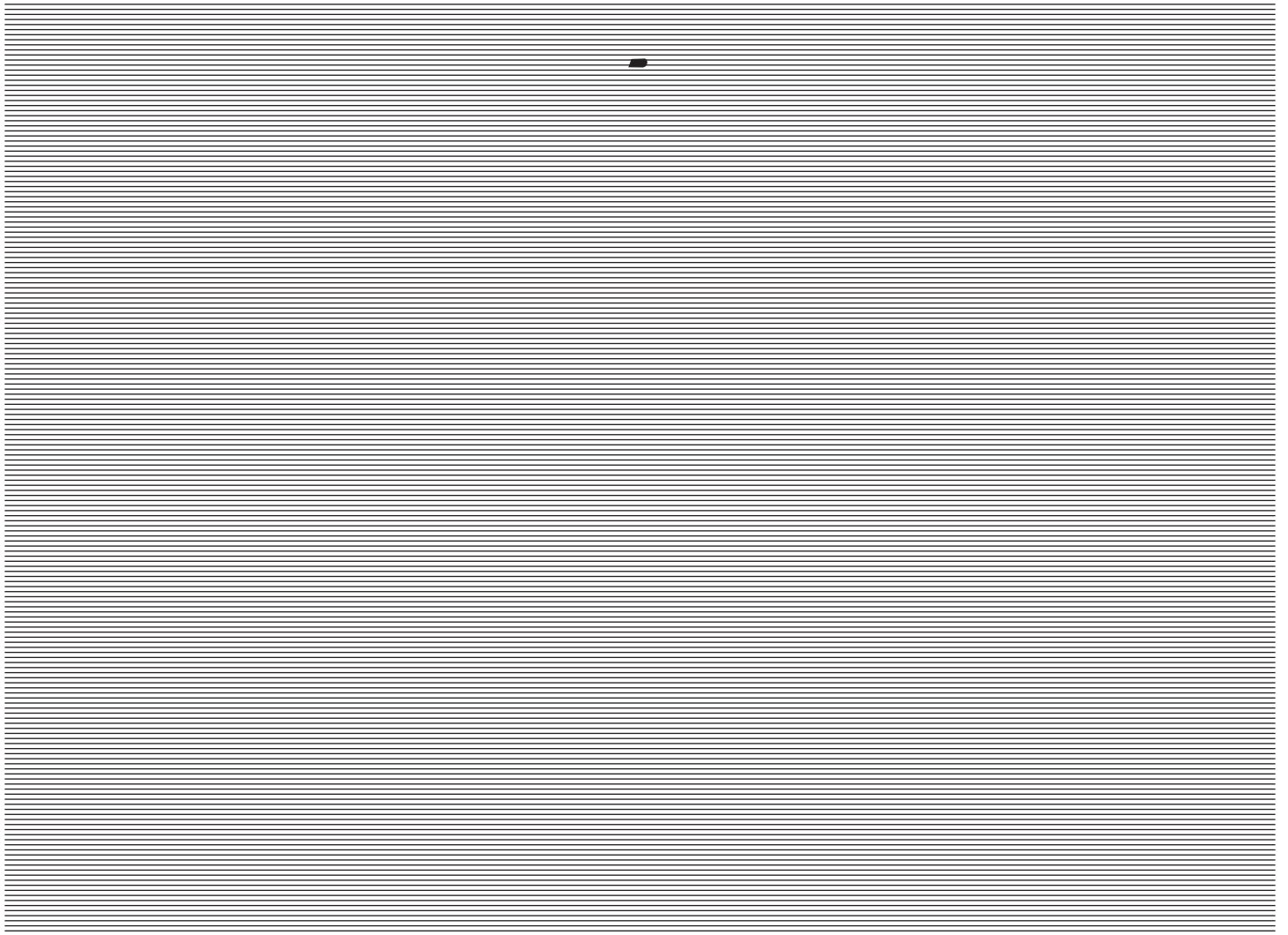

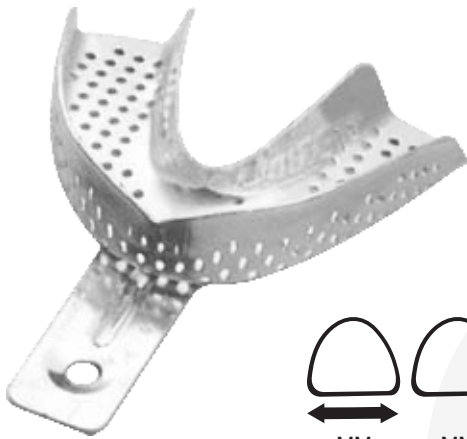
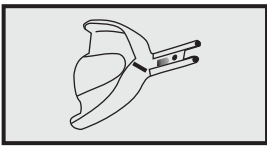

		MM	MM
SKL-019-U1	XXS	63	48
SKL-019-U2	XS	66	51
SKL-019-U3	S	68	54
SKL-019-U4	M	71	58
SKL-019-U5	L	74	62
SKL-019-U6	XL	76	63

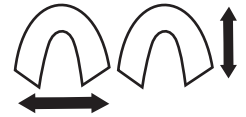
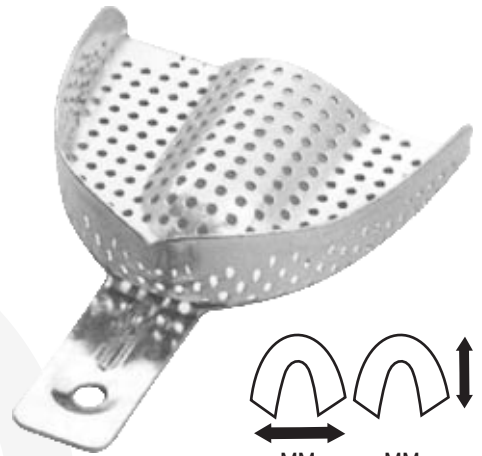

		MM	MM
SKL-021-L1	XXS	56	48
SKL-021-L2	XS	59	50
SKL-021-L3	S	72	52
SKL-021-L4	M	76	57
SKL-021-L5	L	77	56
SKL-021-L6	XL	78	59

Set of Twelve SKL-022-12

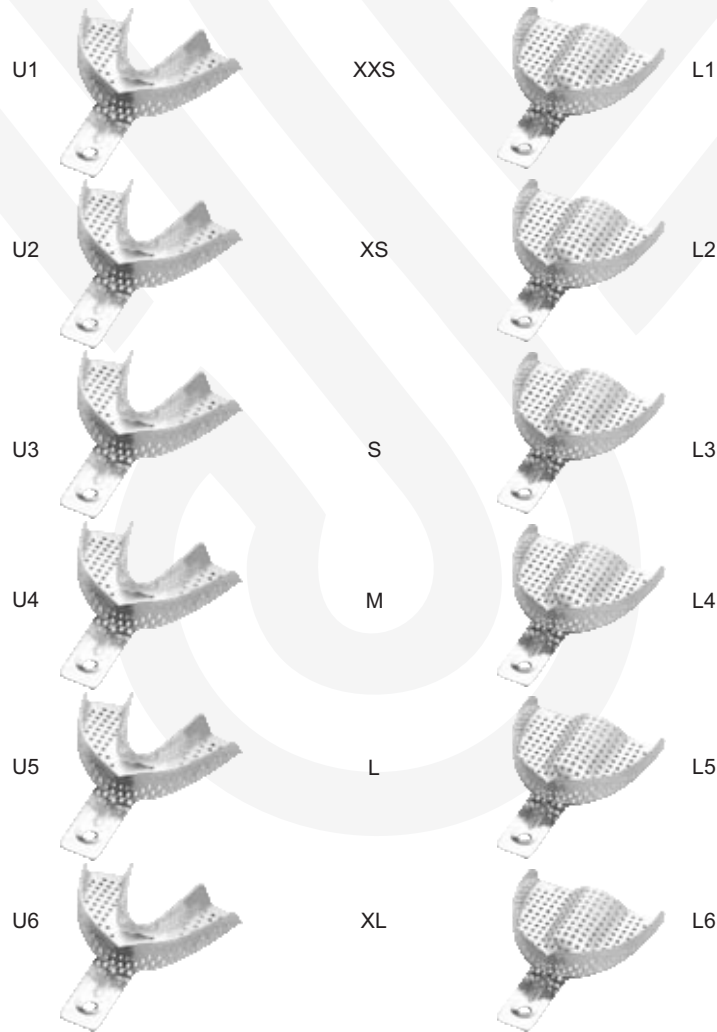

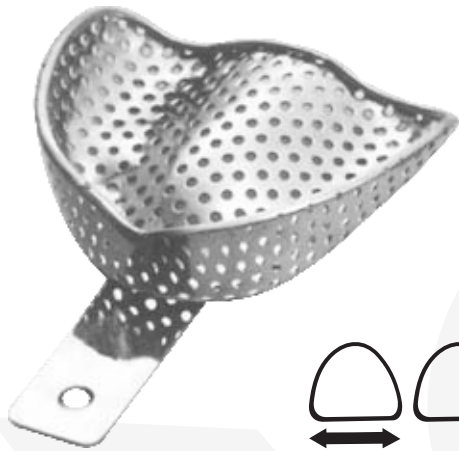
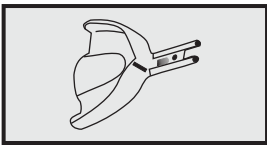

		MM	MM
SKL-023-U1	L	81	67
SKL-023-U4	M	71	64
SKL-023-U7	S	70	57



		MM	MM
SKL-025-L20	L	81	60
SKL-025-L21	M	79	57
SKL-025-L22	S	76	54

Set of Six SKL-027-06

U1



L



L20

U4



M



L21

U7



S

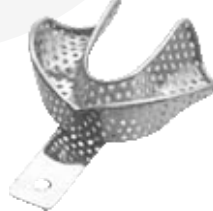

L22

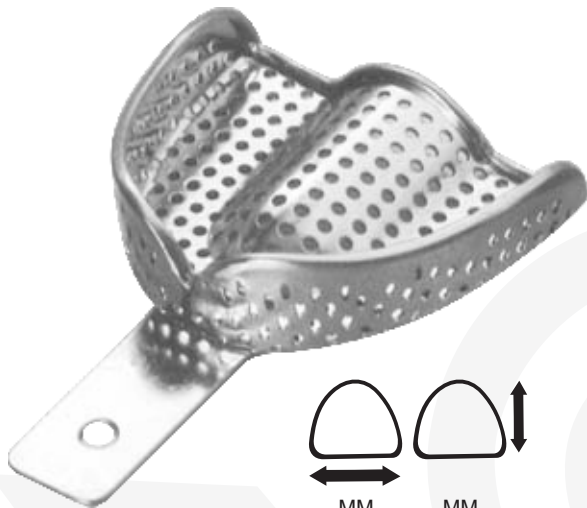
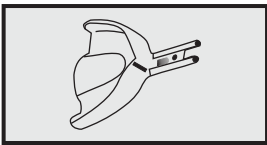

		MM	MM
SKL-029-U1	XXS	63	47
SKL-029-U2	XS	64	51
SKL-029-U3	S	66	53
SKL-029-U4	M	69	57
SKL-029-U5	L	71	60
SKL-029-U6	XL	73	62



		MM	MM
SKL-031-L1	XXS	55	47
SKL-031-L2	XS	60	49
SKL-031-L3	S	72	54
SKL-031-L4	M	74	57
SKL-031-L5	L	76	59
SKL-031-L6	XL	78	61

Set of Twelve SKL-033-12

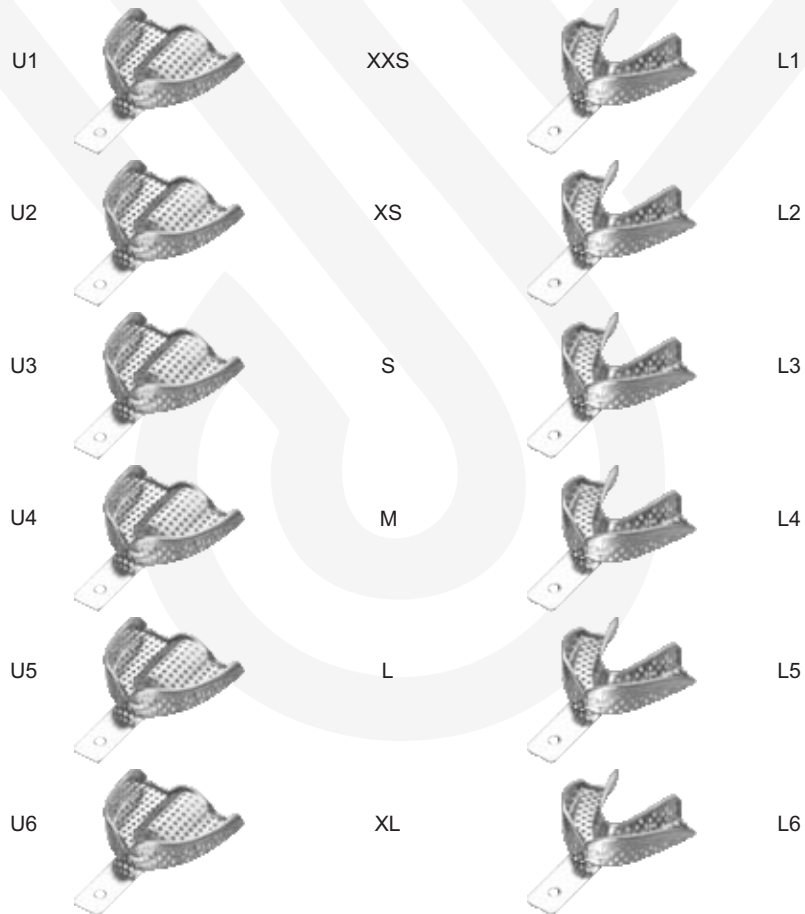

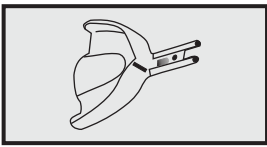

		MM	MM
SKL-035-U1	L	81	67
SKL-035-U4	M	71	64
SKL-035-U7	S	70	57



		MM	MM
SKL-037-L20	L	81	60
SKL-037-L21	M	79	57
SKL-037-L22	S	76	54

Set of Six SKL-039-06

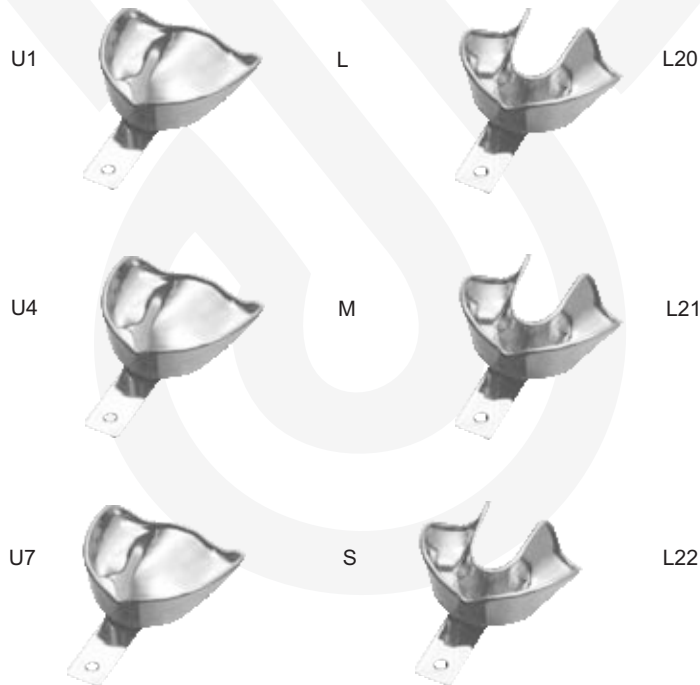

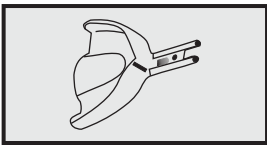

		MM	MM
SKL-041-U1	L	81	67
SKL-041-U4	M	71	64
SKL-041-U7	S	70	57



		MM	MM
SKL-043-L20	L	81	60
SKL-043-L21	M	79	57
SKL-043-L22	S	76	54

Set of Six SKL-045-06

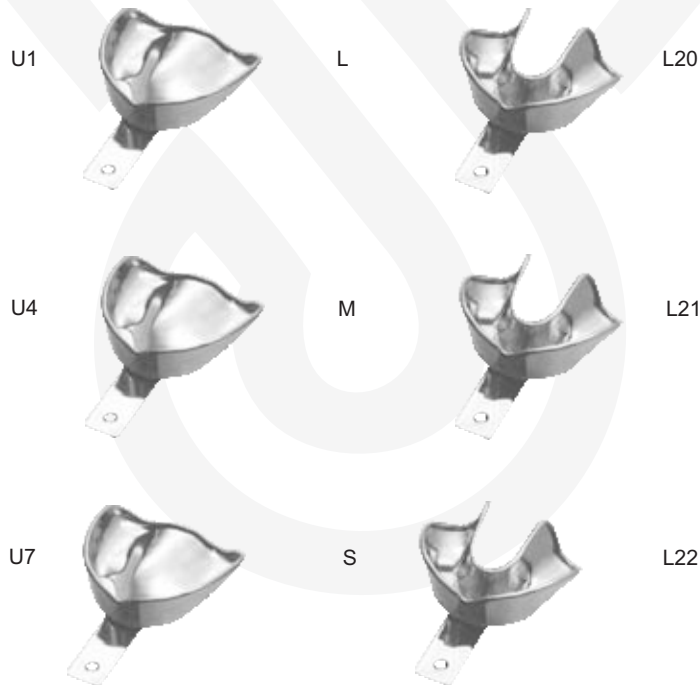

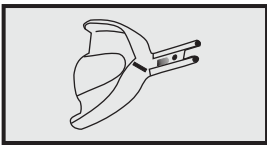

		MM	MM
SKL-047-U1	XL	73	62
SKL-047-U2	L	71	60
SKL-047-U3	M	69	57
SKL-047-U4	S	66	53
SKL-047-U5	XS	64	51
SKL-047-U6	XXS	61	47

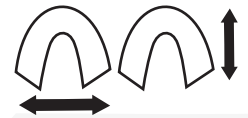

		MM	MM
SKL-049-L1	XL	78	61
SKL-049-L2	L	76	59
SKL-049-L3	M	75	57
SKL-049-L4	S	72	54
SKL-049-L5	XS	60	49
SKL-049-L6	XXS	55	47

Set of Ten SKL-051-12

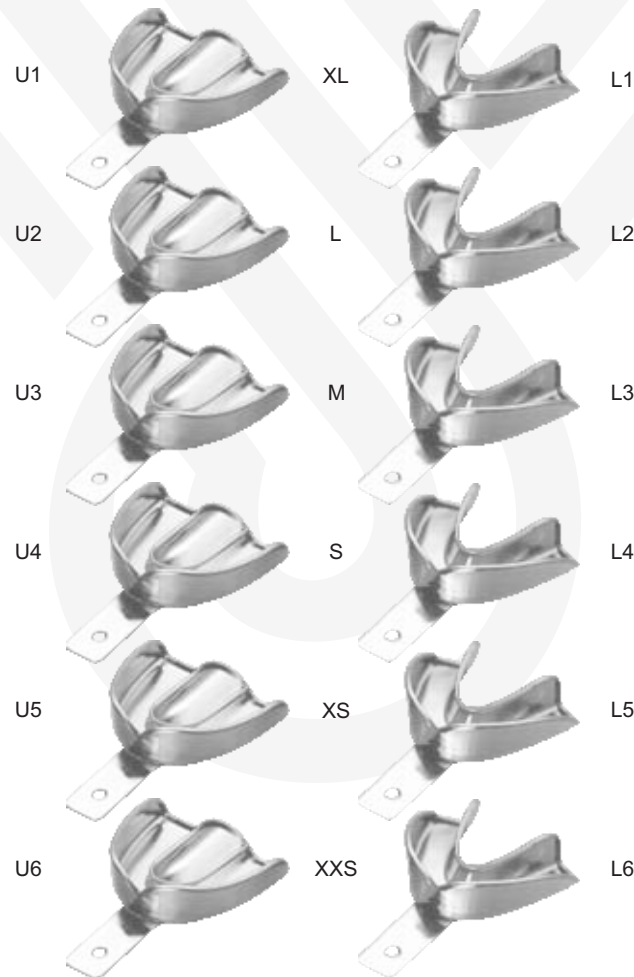

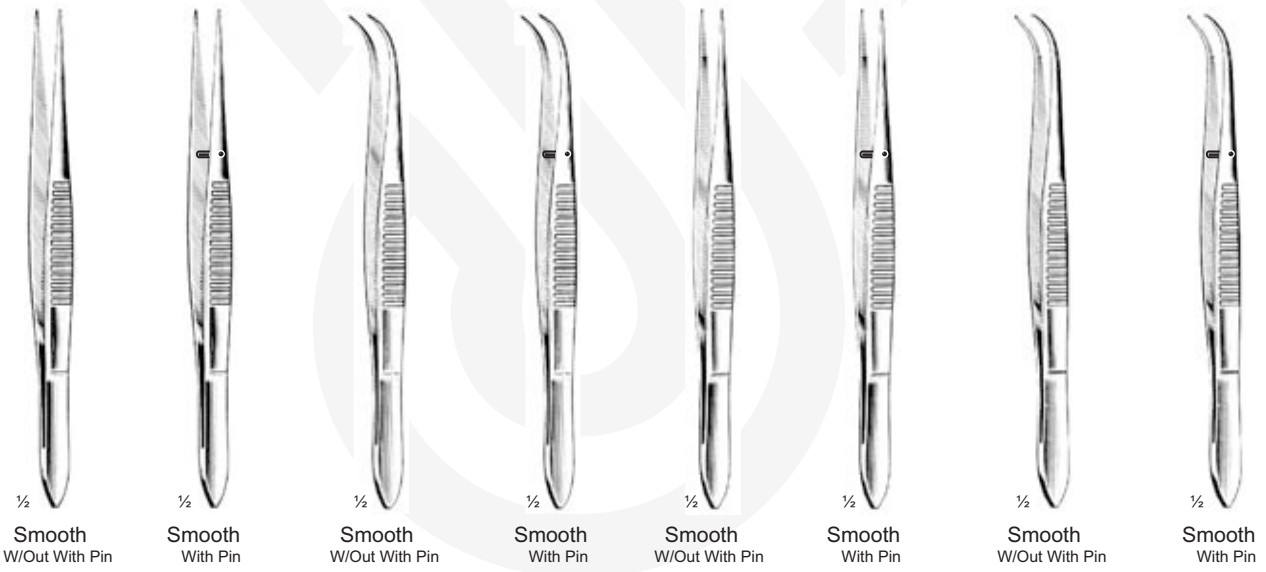
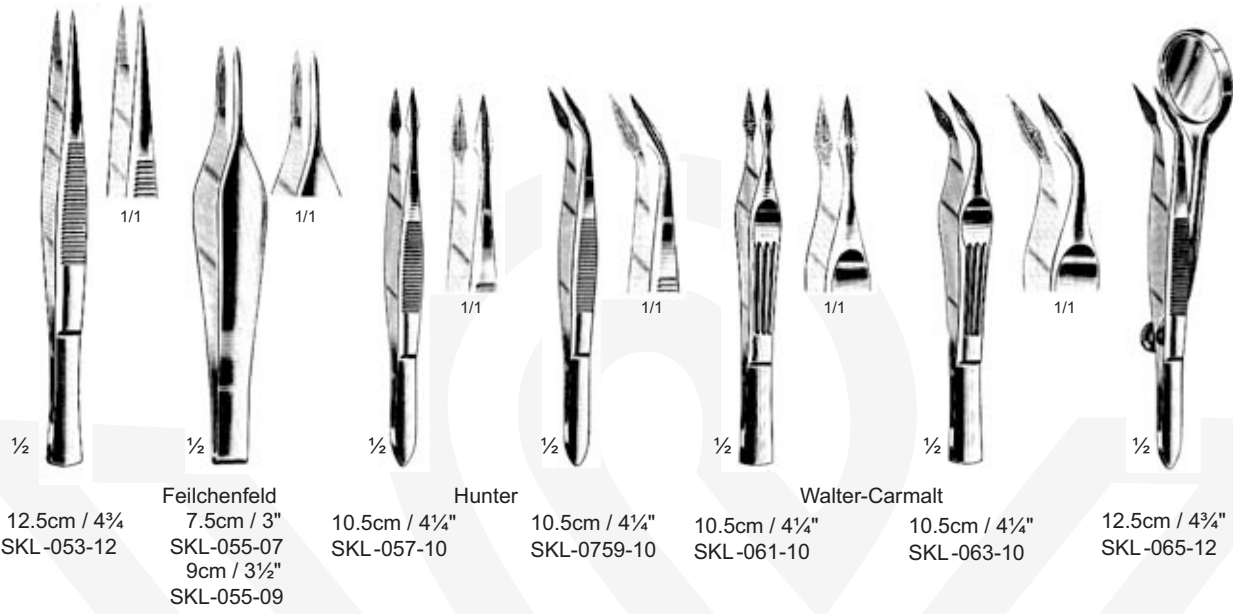

cm	in	SKL-067-08	SKL-069-08	SKL-071-08	SKL-073-08	SKL-075-08	SKL-077-08	SKL-079-08	SKL-081-08
8	3¼	SKL-067-08	SKL-069-08	SKL-071-08	SKL-073-08	SKL-075-08	SKL-077-08	SKL-079-08	SKL-081-08
9	3½	SKL-067-09	SKL-069-09	SKL-071-09	SKL-073-09	SKL-075-09	SKL-077-09	SKL-079-09	SKL-081-09
10.5	4¼	SKL-067-10	SKL-069-10	SKL-071-10	SKL-073-10	SKL-075-11	SKL-077-10	SKL-079-10	SKL-081-10
11.5	4½	SKL-067-11	SKL-069-11	SKL-071-11	SKL-073-11	SKL-075-12	SKL-077-11	SKL-079-11	SKL-081-11
12.5	5	SKL-067-12	SKL-069-12	SKL-071-12	SKL-073-12		SKL-077-12	SKL-079-12	SKL-081-12

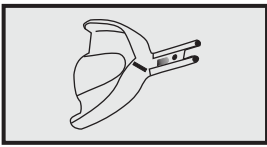

		MM	MM
SKL-053-U1	XL	81	63
SKL-053-U2	L	74	60
SKL-053-U3	M	71	55
SKL-053-U4	NM	67	53
SKL-053-U5	S	65	51



		MM	MM
SKL-055-L1	XL	80	63
SKL-055-L2	L	78	59
SKL-055-L3	M	76	57
SKL-055-L4	NM	72	57
SKL-055-L5	S	69	50

Set of Ten SKL-057-10

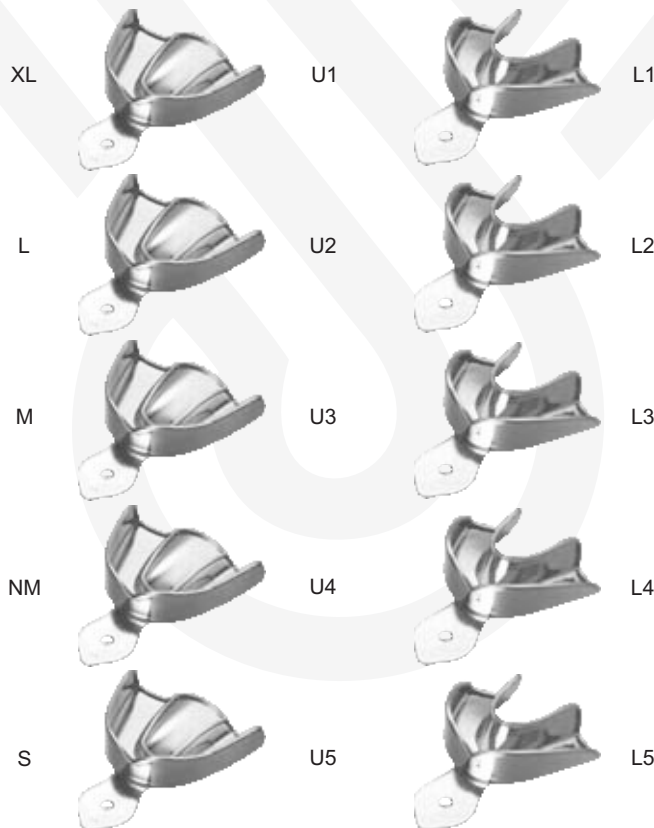

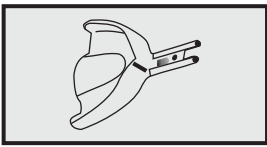

		MM	MM
SKL-059-U1	XL	68	62
SKL-059-U2	L	75	60
SKL-059-U3	M	73	53
SKL-059-U4	NM	69	54
SKL-059-U5	S	68	52



		MM	MM
SKL-061-L1	XL	82	63
SKL-061-L2	L	81	61
SKL-061-L3	M	78	57
SKL-061-L4	NM	74	60
SKL-061-L5	S	71	53

Set of Ten SKL-063-10

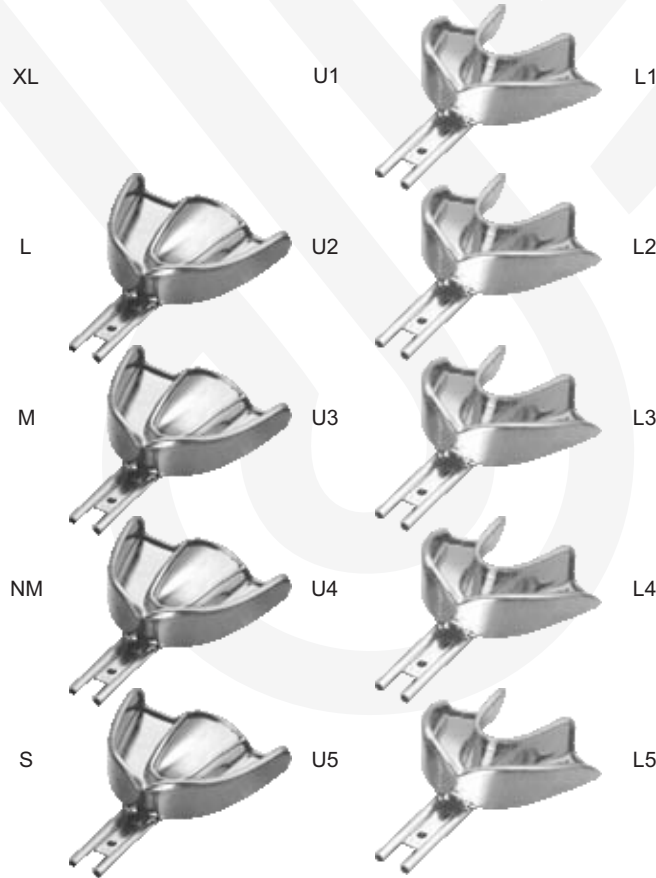

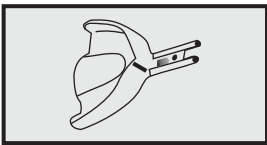

Form C 1/2 R

Form C 1/2 R

fig.	perforated	unperforated
1	SKL-065-01	SKL-067-11
2	SKL-065-02	SKL-067-12
3	SKL-065-03	SKL-067-13
4	SKL-065-04	SKL-067-14



Form C 1/2 L

Form C 1/2 L

fig.	perforated	unperforated
1	SKL-069-01	SKL-071-11
2	SKL-069-02	SKL-071-12
3	SKL-069-03	SKL-071-13
4	SKL-069-04	SKL-071-14



Universal
SKL-073-01

with swivel handle and fixing screw



Universal
SKL-075-11



SKL-077-01

with swivel handle



SKL-079-11

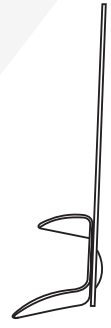

Stolley
SKL-081-01

with swivel handle and slide



Stolley
SKL-083-11



Melotte
SKL-085-11

for crown work

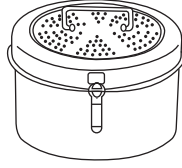

14

STERILIZING BOXES



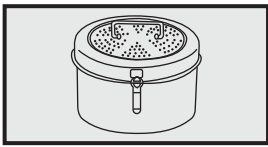

∅ mm	h mm	
80	80	SKL-001-01
120	120	SKL-001-02
160	120	SKL-001-03
160	150	SKL-001-04
190	140	SKL-001-05
190	200	SKL-001-06
240	120	SKL-001-07
240	160	SKL-001-08
240	240	SKL-001-09
290	120	SKL-001-10
290	160	SKL-001-11
290	240	SKL-001-12
340	160	SKL-001-13
340	240	SKL-001-14
390	145	SKL-001-15
390	200	SKL-001-16
390	290	SKL-001-17



135 mm x 100 x 25 mm
SKL-003-25



Proper
78 mm∅x 63 mm
SKL-005-63



65 mm∅ x 15 mm
SKL-007-15



150 mm x 95 X 13 mm
SKL-009-13



150 mm x 95 X 13 mm
SKL-011-13

SKL-001-01	SKL-001-17	Dressing Sterilizing Drum
	SKL-003-25	Case for Impression Trays
	SKL-005-63	Bur-Cleaning and Storing Box
	SKL-007-15	Needle Case
SKL-009-13	SKL-011-13	Boxes and Trays for Burs

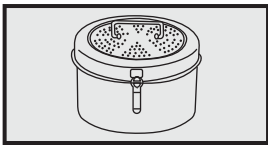

150 mm x 95 X 13 mm
SKL-013-13



150 mm x 95 X 13 mm
SKL-015-13



150 mm x 95 X 13 mm
SKL-017-13

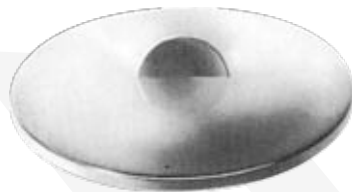

SKL-019-13



∅ 110 X 27 mm SKL-021-27
∅ 110 x 40 mm SKL-023-40



150 mm x 95 X 13 mm
SKL-025-13



150 mm x 95 X 13 mm
SKL-027-13



∅ X h	Capacity	Satin Finish	Highly Polished
116 x 50	0.35	SKL-029-50	SKL-031-50
128 x 55	0.45	SKL-029-55	SKL-031-55
147 x 65	0.7	SKL-029-65	SKL-031-65
167 x 75	1.1	SKL-029-75	SKL-031-75
187 x 85	1.6	SKL-029-85	SKL-031-85



∅ X h	Capacity	Satin Finish	Highly Polished
116 x 35	0.3	SKL-033-35	SKL-035-35
128 x 38	0.4	SKL-033-38	SKL-035-38
147 x 40	0.5	SKL-033-40	SKL-035-40
167 x 45	0.75	SKL-033-45	SKL-035-45
187 x 45	1.0	SKL-033-54	SKL-035-54

SKL-013-13	SKL-027-13	Boxes and Trays for Burs
SKL-021-27	AE 21-023-40	Multipurpose Dish
SKL-029-50	SKL-035-54	Multipurpose Bowls

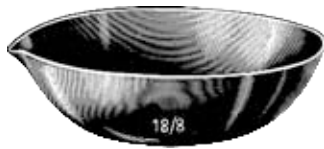
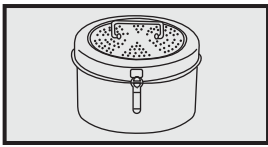

∅ x h
110 x 128 SKL-037-12



∅
100 SKL-039-10
120 SKL-039-12
150 SKL-039-15



100 cc
SKL-041-01



l x b x h	Satin Finish	Highly Polished
230 x 155 x 30	SKL-043-01	SKL-045-01
300 x 175 x 30	SKL-043-02	SKL-045-02
300 x 175 x 40	SKL-043-03	SKL-045-03
350 x 240 x 36	SKL-043-04	
400 x 300 x 50	SKL-043-05	



0.5L SKL-047-05
1.0L SKL-049-10
2.0L SKL-051-20



Dish + Lid	100 x 20 mm	SKL-053-01
Dish only	96 x 20 mm	SKL-055-09
Lid only	100 x 16 mm	SKL-057-10

Dish + Lid	100 x 20 mm	SKL-059-01
Dish only	96 x 20 mm	SKL-061-09
Lid only	100 x 16 mm	SKL-063-10



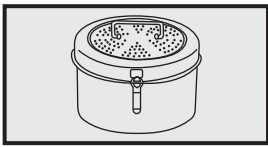

235 x 190 x 40 mm
SKL-065-40



Ø 220 x 70 mm
SKL-067-70



l x b x h	Satin Finish
210 x 160 x 10	SKL-069-01
240 x 180 x 10	SKL-069-02
310 x 150 x 10	SKL-069-03
310 x 210 x 10	SKL-069-04
350 x 240 x 10	SKL-069-05
350 x 240 x 20	SKL-069-06
400 x 270 x 20	SKL-069-07
420 x 280 x 10	SKL-069-08



Ø x h	Lid only	Jar without lid
30 x 90	SKL-071-01	SKL-073-01
50 x 100	SKL-071-02	SKL-073-02
50 x 130	SKL-071-03	SKL-073-03
50 x 175	SKL-071-04	SKL-073-04
75 x 100	SKL-071-05	SKL-073-05
75 x 130	SKL-071-06	SKL-073-06
75 x 175	SKL-071-07	SKL-073-07
100 x 175	SKL-071-08	SKL-073-08
100 x 200	SKL-071-09	SKL-073-09

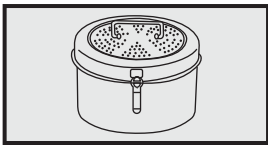

Ø x h	With lid without knob	Lid with knob
75 x 60	SKL-075-01	SKL-077-01
75 x 75	SKL-075-02	SKL-077-02
100 x 60	SKL-075-03	SKL-077-03
100 x 100	SKL-075-04	SKL-077-04
125 x 80	SKL-075-05	SKL-077-05
125 x 125	SKL-075-06	SKL-077-06
135 x 20	SKL-075-07	SKL-077-07
135 x 35	SKL-075-08	SKL-077-08
135 x 50	SKL-075-09	SKL-077-09
135 x 100	SKL-075-10	SKL-077-10
150 x 100	SKL-075-11	SKL-077-11
150 x 150	SKL-075-12	SKL-077-12
200 x 100	SKL-075-13	SKL-077-13
200 x 150	SKL-075-14	SKL-077-14
200 x 200	SKL-075-15	SKL-077-15



205 x 105 x 40 mm
SKL-079-40



20 cc
SKL-081-20
Medicine Cup



50 cc
SKL-083-50
Medicine Cup



25 cc
SKL-085-25
Medicine Cup



l x b x h	With lid without knob	Lid with knob
165 x 85 x 35	SKL-087-01	SKL-089-01
200 x 100 x 35	SKL-087-02	SKL-089-02
200 x 100 x 50	SKL-087-03	SKL-089-03
230 x 130 x 50	SKL-087-04	SKL-089-04
260 x 150 x 50	SKL-087-05	SKL-089-05
270 x 235 x 50	SKL-087-06	SKL-089-06
300 x 200 x 50	SKL-087-07	SKL-089-07
325 x 275 x 30	SKL-087-08	SKL-089-08

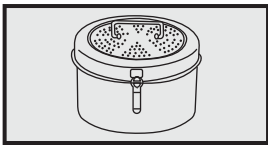

Ø 90 x 90 mm
SKL-091-90



Ø 75 x 50 mm
SKL-093-75



Ø 75 x 12 mm
SKL-095-75



250 x 115 x 15 mm
SKL-097-15



250 x 115 x 15 mm
SKL-099-25



250 x 115 x 15 mm
SKL-101-52

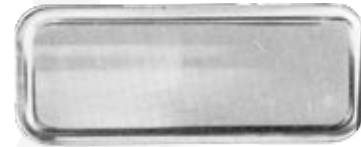

l x b x h	Perforated	Not Perforated
55 x 29 x 6	SKL-103-55	SKL-105-55
75 x 29 x 6	SKL-103-75	SKL-105-75
90 x 37 x 6	SKL-103-90	SKL-105-90

SKL-091-90	Tumblers
SKL-093-75	Container for Dentures
SKL-095-75	Trays for Tablets
SKL-097-15	SKL-105-90
	Trays



2/3

London Collage
15 cm / 6"

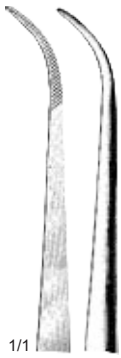

1/1

1

SKL-083-01



1/1

2

SKL-083-02



1/1

3

SKL-083-03



1/1

4

SKL-085-04



1/1

5

SKL-085-05



1/1

6

SKL-085-06



1/1

7

SKL-085-07



2/3

London Collage
15 cm / 6"



1/1

1

SKL-087-01



1/1

2

SKL-087-02



1/1

3

SKL-087-03



1/1

4

SKL-087-04



1/1

5

SKL-089-05



1/1

6

SKL-089-06



1/1

7

SKL-089-07

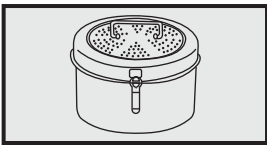

Ø 75 x 80 mm
SKL-107-75



Ø 75 x 80 mm
SKL-109-75



Methot
Ø 50 x 75 mm
SKL-111-50



Ø 75 x 90 mm SKL-113-75
100 x 30 mm SKL-113-10



Ø 75 x 90 mm
SKL-115-57



l x b x h
170 x 100 x 35
250 x 140 x 40
275 x 150 x 45

Lid only

SKL-117-40

Bowl only

SKL-119-35
SKL-119-40
SKL-119-45

SKL-107-75	SKL-109-75	Sputum Cups
	SKL-111-50	Cotton Wool Holders
SKL-113-75	SKL-113-10	Cotton Wool Dispenser
	SKL-115-57	Waste Receptacle
SKL-119-35	SKL-119-45	Instrument Tray, Kidney Shaped



Flagg
15 cm / 6"

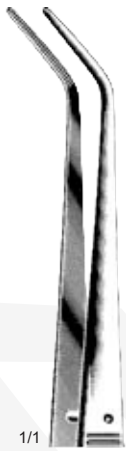

1
SKL-091-01



2
SKL-091-02



3
SKL-091-03



4
SKL-091-04



5
SKL-091-05



6
SKL-091-06



1
SKL-093-01

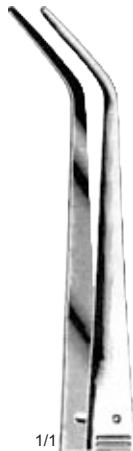

2
SKL-093-02



3
SKL-093-03



4
SKL-093-04



5
SKL-093-05



6
SKL-093-06



Meriam
15 cm / 6"



Landgraf
15 cm / 6"



1/1
1
SKL-095-01



1/1
2
SKL-095-02



1/1
3
SKL-095-03



1/1
4
SKL-095-04

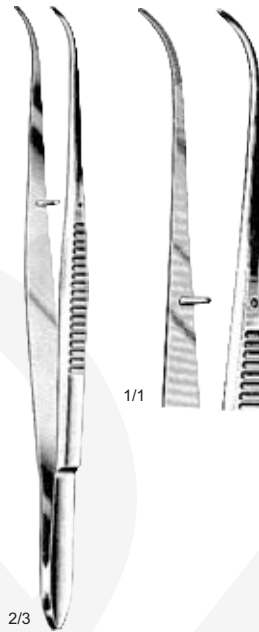

2/3
Perry
12.5 cm / 5"
SKL-097-12



2/3
Perry
12.5 cm / 5"
SKL-099-12



2/3
Zeibe
12.5 cm / 5"
SKL-101-12



1/2
Mod Martin
Suture & Membrane Forceps

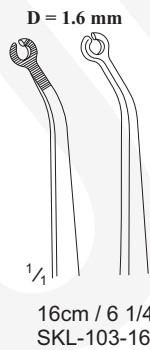

1/2
Mod Martin
Suture & Membrane Forceps

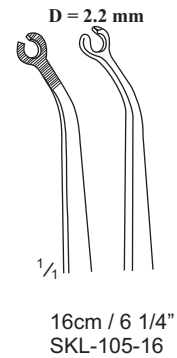



$\frac{2}{3}$
13.5cm/5¼"
SKL-109-01



$\frac{2}{3}$
13.5cm/5¼"
SKL-111-01



$\frac{2}{3}$
14cm/5½"
SKL-113-01



1/1
Miller
15 cm / 6"
SKL-121-16
Practicing Paper
Forcep



Brom-Allen
16.5 cm/6 ½"
SKL-115-16



$\frac{2}{3}$
Albrecht
16 cm/6 ¼"
SKL-117-16



$\frac{2}{3}$
Albrecht
16 cm/6 ¼"
SKL-119-16



2/3
16cm/6 1/4"
SKL-123-16



2/3
16cm/6 1/4"
SKL-125-16



2/3
12.5cm/5"
SKL-127-12



2/3
13cm/4 3/4"
SKL-129-13



2/3
12cm/4 1/2"
SKL-131-12



2/3
11.5cm/4 1/2"
SKL-133-11



2/3
11.5cm/4 1/2"
SKL-135-16



1/2
17 cm / 6 3/4"
SKL-137-17



1/2
17 cm / 6 3/4"
SKL-139-17



1/2
12 cm / 4 3/4" SKL-141-12
14 cm / 5 1/2" SKL-141-14
16 cm / 6 1/4" SKL-141-16



1/2
13 cm / 5 1/2"
SKL-143-13



1/1
9 cm / 3 1/2"
SKL-145-09



1/1
9 cm / 3 1/2"
SKL-147-09

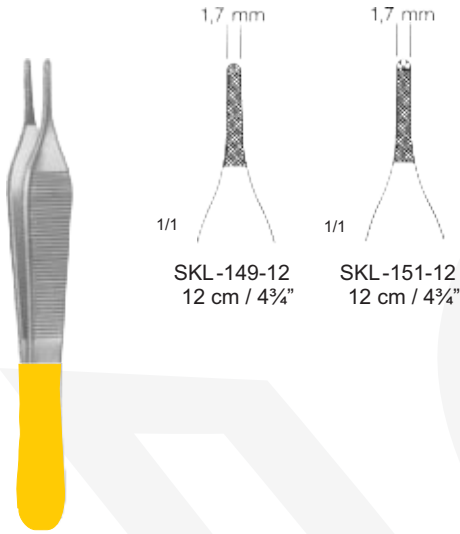

1,7 mm
1/1
SKL-149-12
12 cm / 4¾"

1,7 mm
1/1
SKL-151-12
12 cm / 4¾"

Adson



1,6 mm
1/1
SKL-153-16
16 cm / 6¼"

Meriam

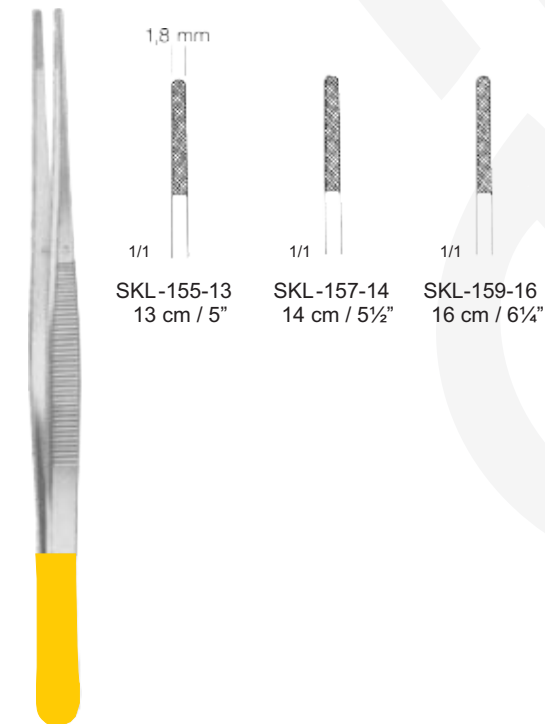

1,8 mm
1/1
SKL-155-13
13 cm / 5"

1,8 mm
1/1
SKL-157-14
14 cm / 5½"

1,8 mm
1/1
SKL-159-16
16 cm / 6¼"

Standard

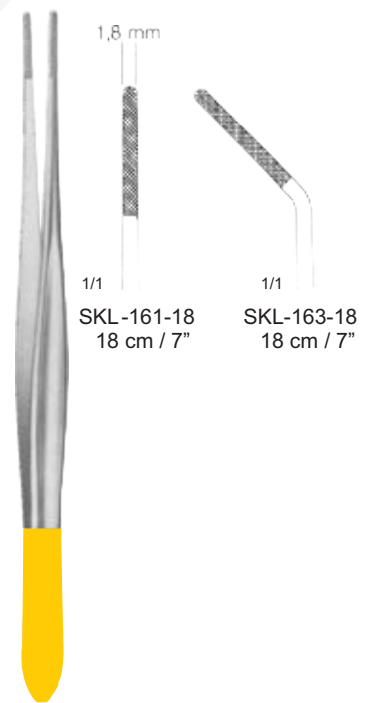

1,8 mm
1/1
SKL-161-18
18 cm / 7"

1,8 mm
1/1
SKL-163-18
18 cm / 7"

Cushing

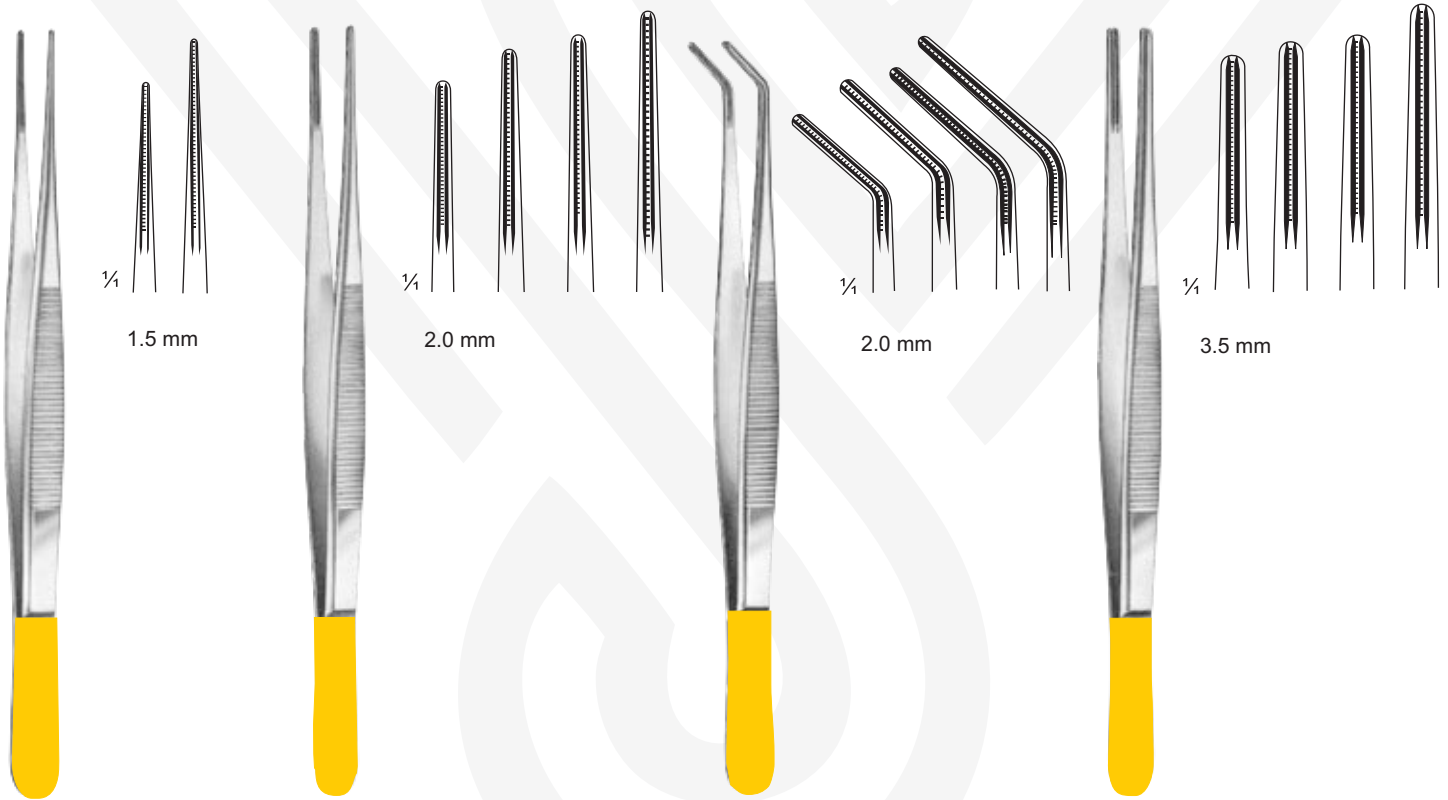

DeBakey

SKL-165-16 = 16 cm/6 1/4"
SKL-165-20 = 20 cm/8"

SKL-167-16 = 16 cm/6 1/4"
SKL-167-20 = 20 cm/8"
SKL-167-24 = 24 cm/9 1/4"
SKL-167-30 = 30 cm/12"

SKL-169-16 = 16 cm/6 1/4"
SKL-169-20 = 20 cm/8"
SKL-169-24 = 24 cm/9 1/4"
SKL-169-30 = 30 cm/12"

De Bakey

SKL-171-16 = 16 cm/6 1/4"
SKL-171-20 = 20 cm/8"
SKL-171-24 = 24 cm/9 1/4"
SKL-171-30 = 30 cm/12"

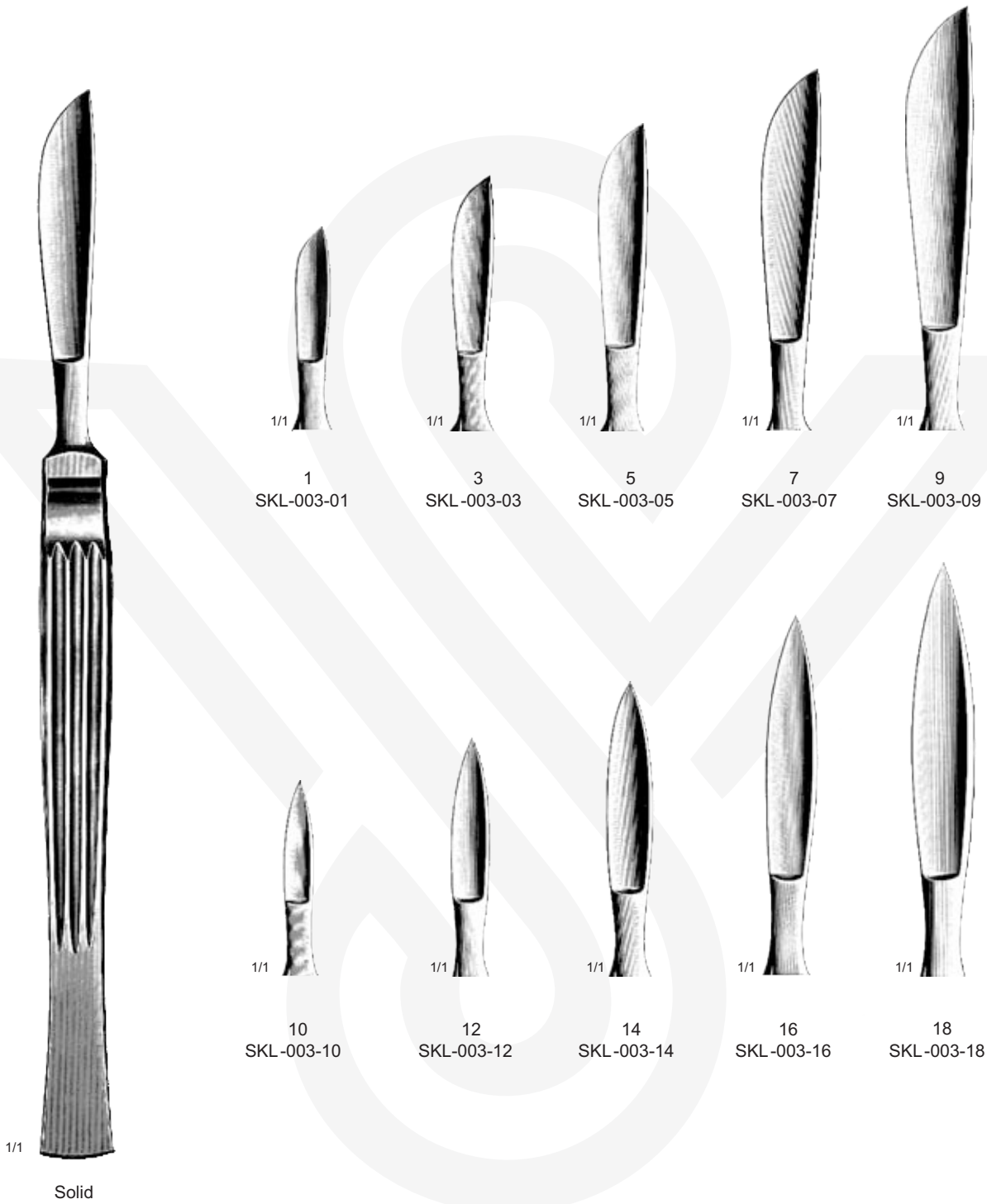

SKL-003-01 SKL-003-03 SKL-003-05 SKL-003-07 SKL-003-09
SKL-003-10 SKL-003-12 SKL-003-14 SKL-003-16 SKL-003-18
Knives with Solid Handle



Periodontal pocket makers

15cm / 6"
SKL-173-30
(Crane-Kaplan)
Goldman-fox

15cm / 6"
SKL-175-30
(Crane-Kaplan)
Goldman-fox

16cm / 6½"
SKL-177-30
Fig-18L
Locking

15cm / 6"
SKL-179-30
Fig-1
Self Locking

15cm / 6"
SKL-181-30
Fig-2
Self Locking



14 cm/5 1/2"
SKL-193-30
self-retaining,
round ends



14 cm/5 1/2"
SKL-195-30
self retaining,
flat ends



	cm	inches	
SKL-197-30	12	4 3/4	SKL-199 -12
SKL-197-14	14	5 1/2	SKL-199-14
SKL-197-16	16	6 1/4	SKL-199-16



13 cm/5 1/8"
SKL-201-13



SKL-205-00
pair

13 cm/5 1/8"
SKL-203-13
SKL-205-00



16 cm/6 1/4"
SKL-207-19
SKL-209-00



16 cm/6 1/4"
SKL-211-16
SKL-213-00

SKL-213-00
pair



16 cm/6 1/4"
SKL-215-16 - SKL-221-02



SKL-215-16
Spare tips, in pairs



SKL-217-16

SKL-219-02

SKL-221-02

insulated handle

SKKYLINE

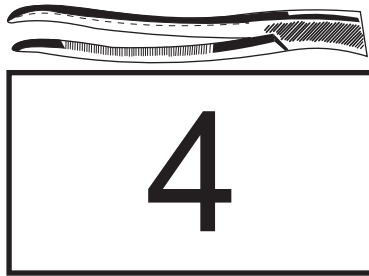

HEMOSTATIC FORCEPS





cm	in	Pean Straight	Curved
13	5	SKL-001-13	SKL-003-13
14	5½	SKL-001-14	SKL-003-14
16	6¼	SKL-001-16	SKL-003-16

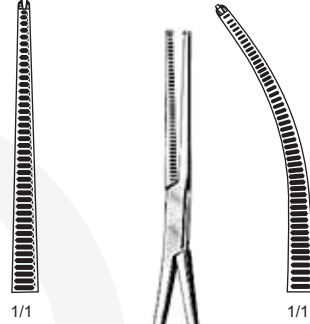

cm	in	Straight	Curved
13	5	SKL-005-13	SKL-007-13
14	5½	SKL-005-14	SKL-007-14
16	6¼	SKL-005-16	SKL-007-16



Kocher

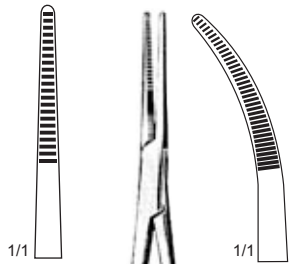

cm	in	Straight	Curved
14	5½	SKL-009-14	SKL-011-14



Kelly
14 cm / 5½"

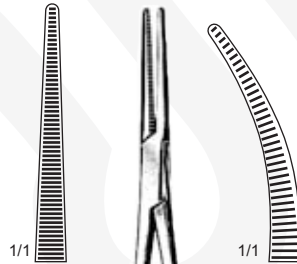

cm	in	Straight	Curved
14	5½	SKL-013-14	SKL-015-14

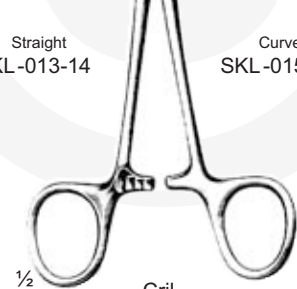

Cril
14 cm / 5½"

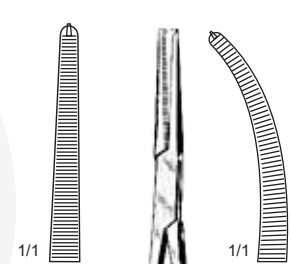

cm	in	Straight	Curved
14	5½	SKL-017-14	SKL-019-14



Cril
14 cm / 5½"

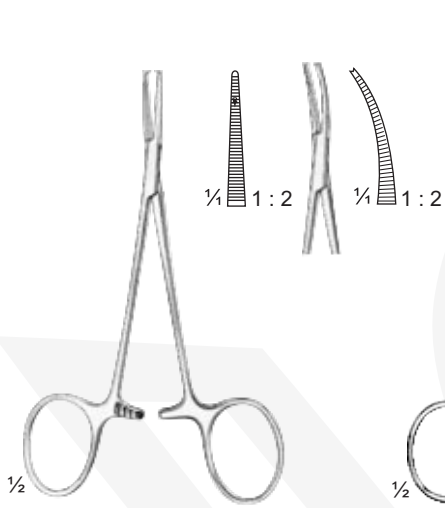

Halstead-Mosquito (Micro)

cm	in	Straight	Curved
12.5	5	SKL-021-12	SKL-023-12



Halstead-Mosquito

cm	in	Straight	Curved
13	5	SKL-025-13	SKL-027-18
18	7	SKL-025-13	SKL-027-18

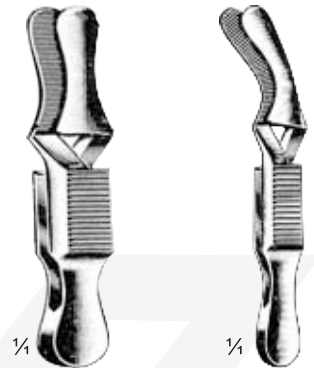

Dieffenbach
3.5 cm / 1 1/2"
SKL-029-03
5 cm / 2"
SKL-029-05

Dieffenbach
3.5 cm / 1 1/2"
SKL-031-04
5 cm / 2"
SKL-031-05

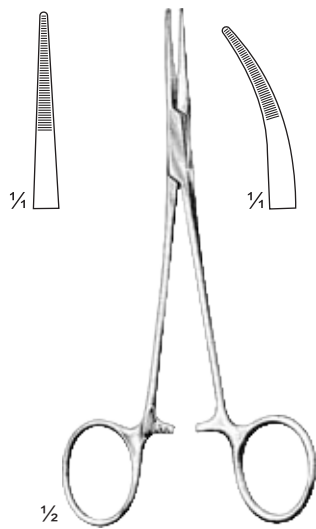

Providence-Hospital

cm	in	Straight	Curved
14	5 1/2	SKL-033-14	SKL-035-14

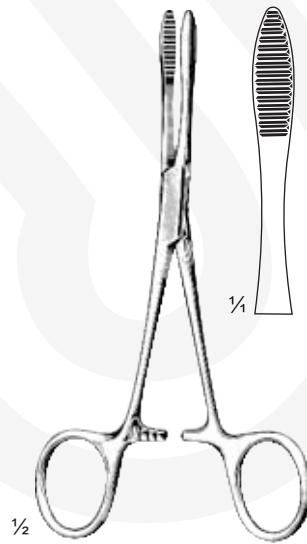

Pean

cm	in	
14	5 1/2	SKL-037-14
16	6 1/4	SKL-037-16

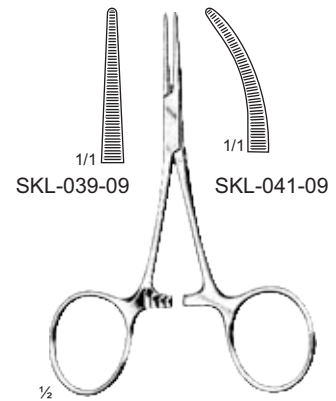

Hartmann
10 cm / 4"

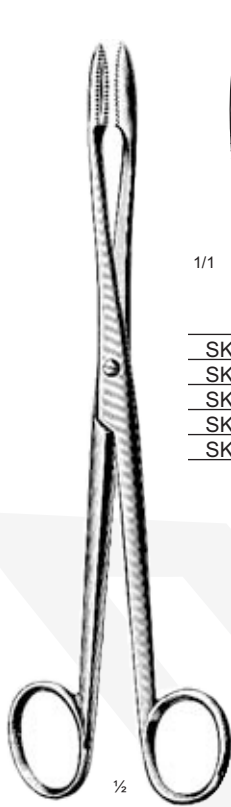

Gross-Maier



		cm	in		
SKL-043-14	SKL-045-14	14.5	5 1/2	SKL-047-14	SKL-049-14
SKL-043-16	SKL-045-16	16	6 1/4	SKL-047-16	SKL-049-16
SKL-043-18	SKL-045-18	18	7	SKL-047-18	SKL-049-18
SKL-043-20	SKL-045-20	20	8	SKL-047-20	SKL-049-20
SKL-043-25	SKL-045-25	25	10	SKL-047-25	SKL-049-25

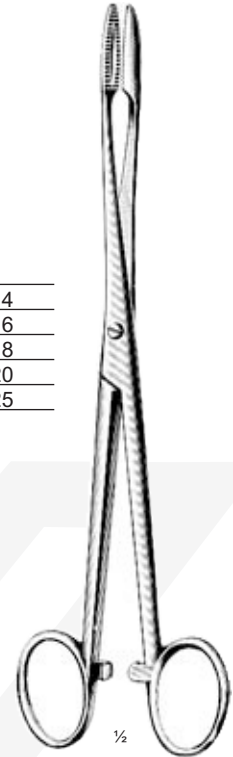

Gross-Maier

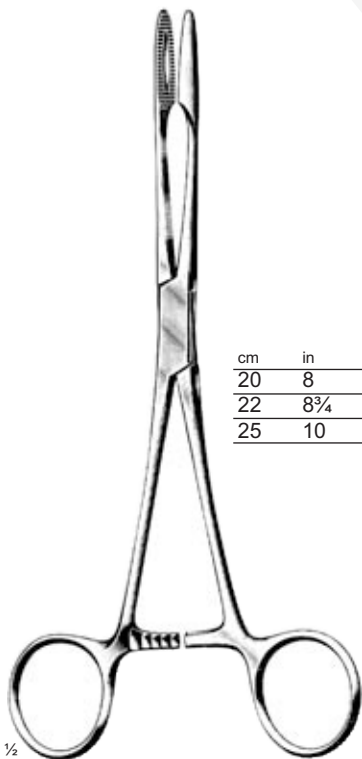

Gross-Maier

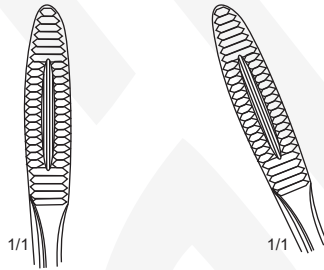

cm	in		
20	8	SKL-051-20	SKL-053-20
22	8 3/4	SKL-051-22	SKL-053-22
25	10	SKL-051-25	SKL-053-25



Backhaus

cm	in	
8	3 1/4	SKL-055-08
11	4 1/2	SKL-055-11
13	5	SKL-055-13
15	6	SKL-055-15



SchZBdel
9 cm / 3 1/2"
SKL-057-09



Jones
5 cm / 2"
SKL-059-05
9 cm / 3 1/2"
SKL-059-09



(4x5 Teeth)
SKL-063-15

(5x6 Teeth)
SKL-065-15

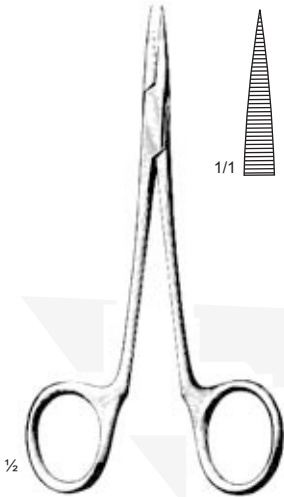

Physician
13 cm / 5"
SKL-061-13



Allis
15 cm / 6"



Babcock
16 cm / 6 1/4"
SKL-067-16

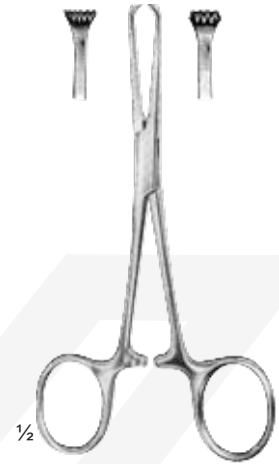

Allis-Baby
14.5 cm / 5 3/4"
SKL-069-14



Cheate
27 cm / 10 1/2"
SKL-071-27

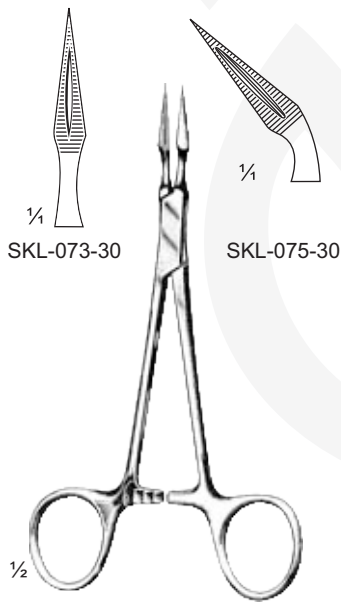

Stieglitz
13.5 cm / 5 1/2"

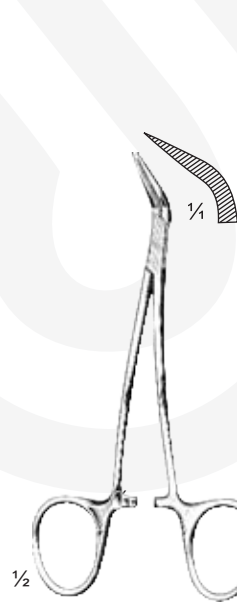

Peet
11.5 cm / 4 1/2"
SKL-077-30

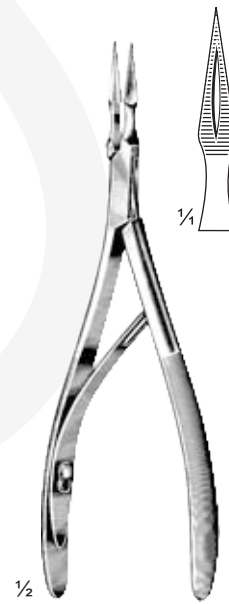

Ralk
15 cm / 6"
SKL-079-30



Ralk
15 cm / 6"
SKL-081-30

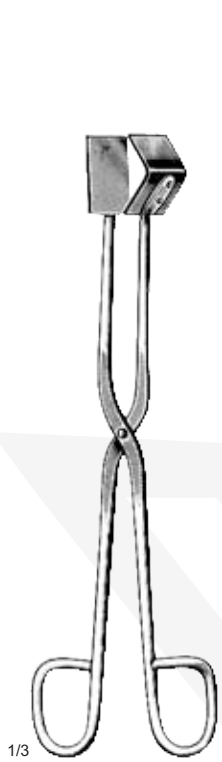

24 cm / 9½"
SKL-083-24



1/2
Universal
20 cm / 8" SKL-085-20
28 cm / 11" SKL-085-28



1/2
Universal
20 cm / 8" SKL-087-20
28 cm / 11" SKL-087-28



1/6
58 cm / 22¾"
SKL-089-58



1/6
Sauerbruch
55 cm / 21½"
SKL-091-55



1/3
22 cm / 8" SKL-093-22
32 cm / 12½" SKL-093-32
50 cm / 20" SKL-093-50



1/3
22 cm / 8" SKL-095-22
25 cm / 10" SKL-095-25
32 cm / 12½" SKL-095-32
50 cm / 20" SKL-095-50



1/3
20 cm / 8" SKL-097-20
30 cm / 12" SKL-097-30



1/3
Rogge
23 cm / 9"
SKL-099-23



1/3
24.5 cm / 9¾"
SKL-101-24

SKKYLINE



ROOT ELEVATORS



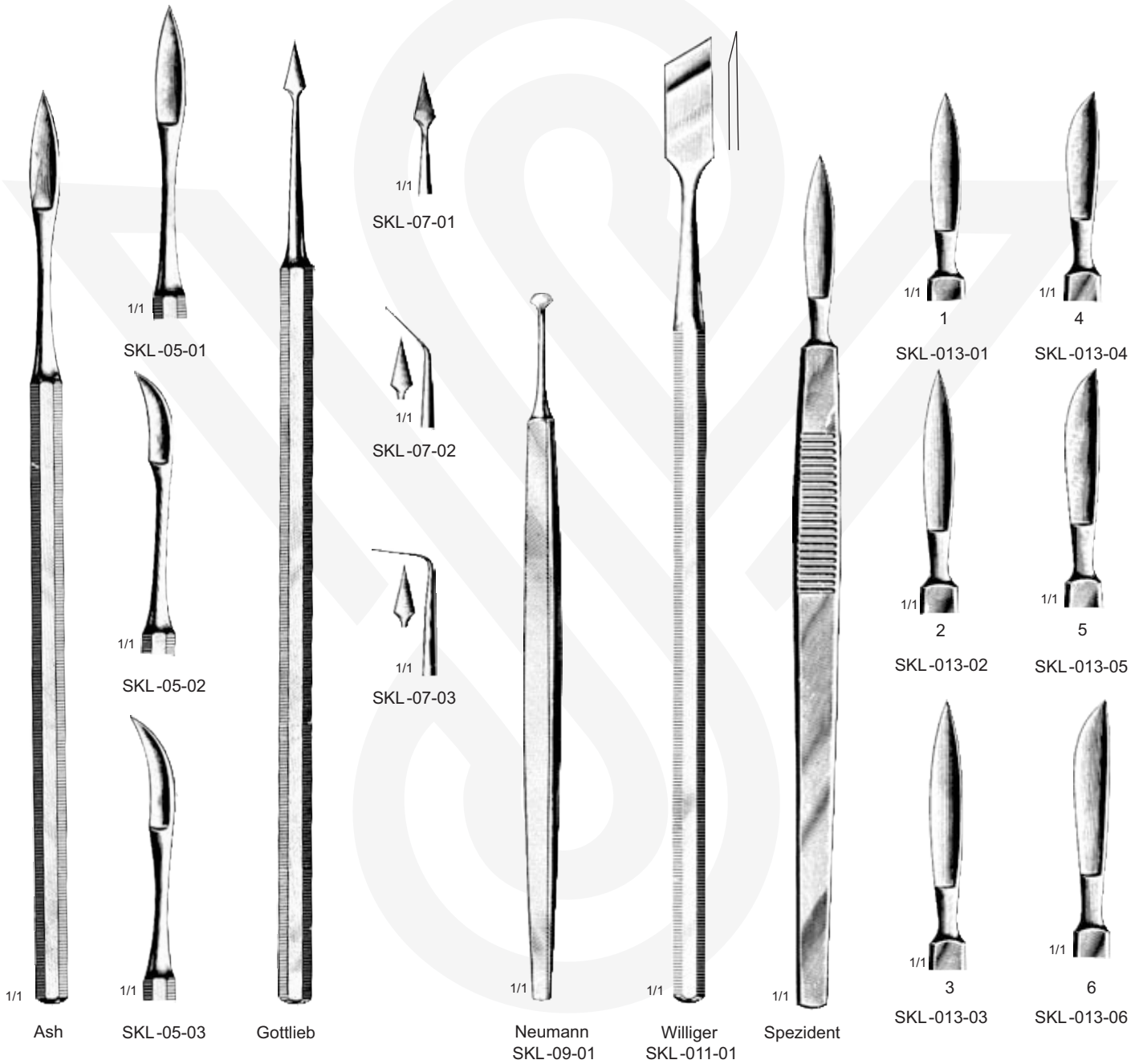



Flohr

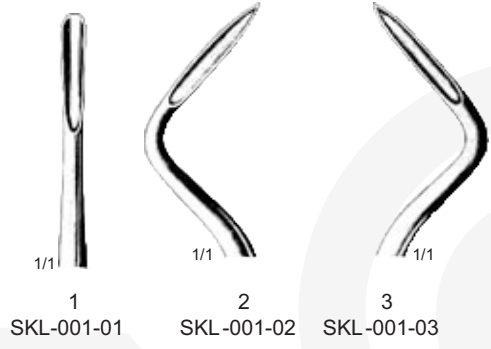

1 SKL-001-01
2 SKL-001-02
3 SKL-001-03



Friedman



1 SKL-003-01
2 SKL-003-02
3 SKL-003-03



Hylin



1 4.5 mm SKL-005-01
2 3 mm SKL-005-02
3 3 mm SKL-005-03
4 3 mm SKL-005-04



1/1
1
3 mm
SKL-007-01

1/1
2
4 mm
SKL-007-02

1/1
1
3 mm
SKL-009-01

1/1
2
4 mm
SKL-009-02

1/1
1
3 mm
SKL-011-01

1/1
2
4 mm
SKL-011-02

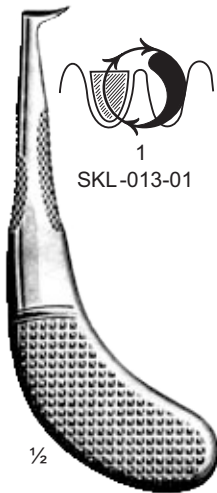

1
SKL-013-01

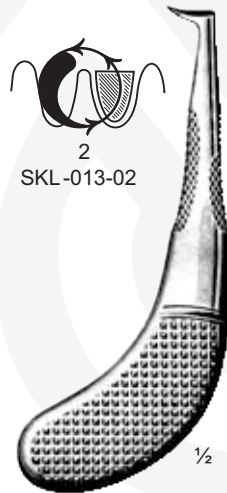

2
SKL-013-02

Krallenheber
SKL-013-00



1
Krallenheber
SKL-015-01

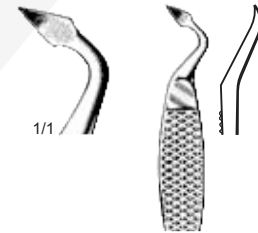

2
SKL-015-02

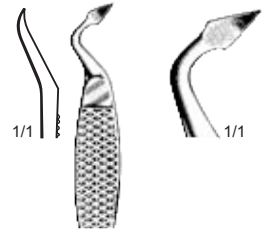

3
SKL-015-03

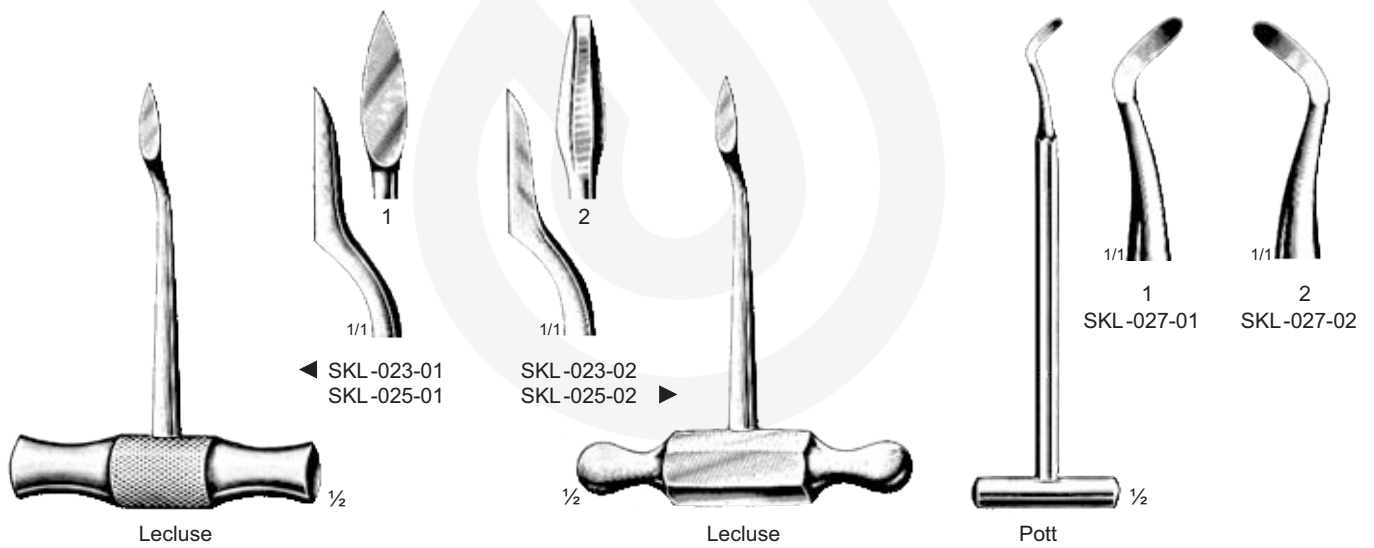
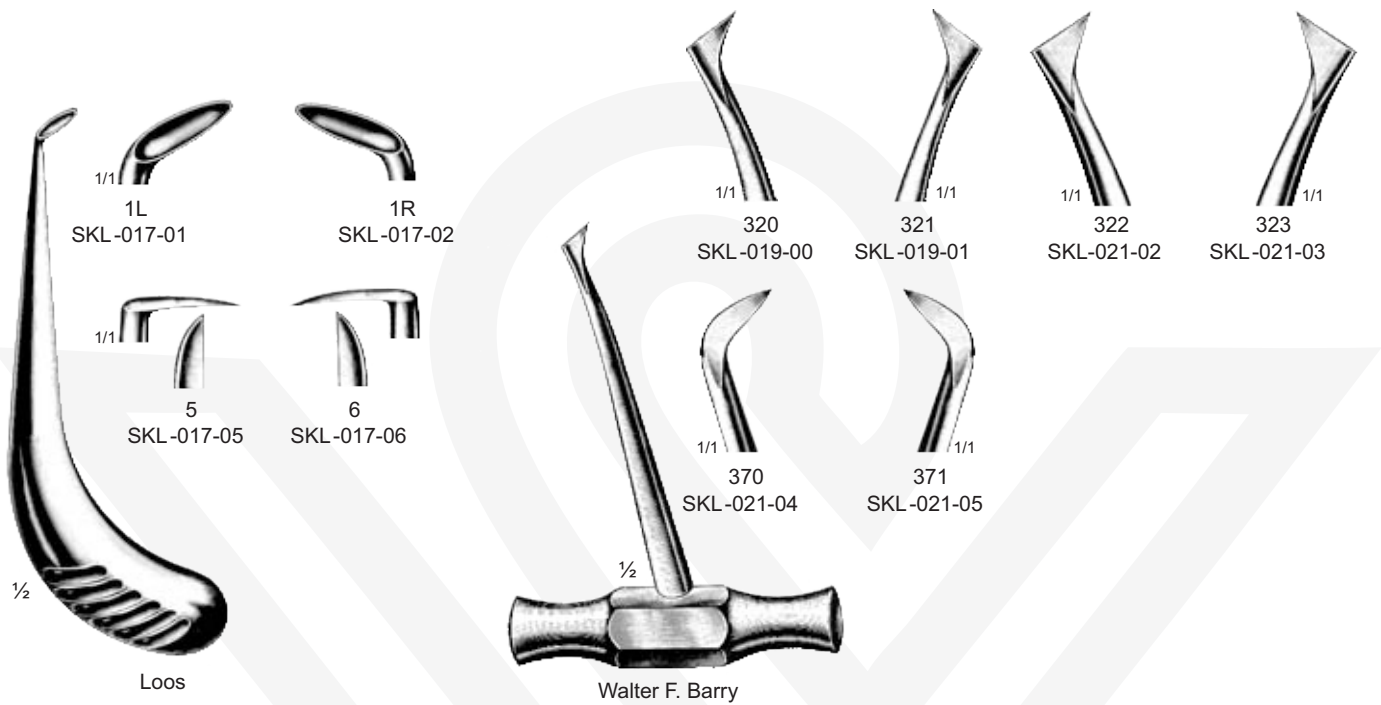

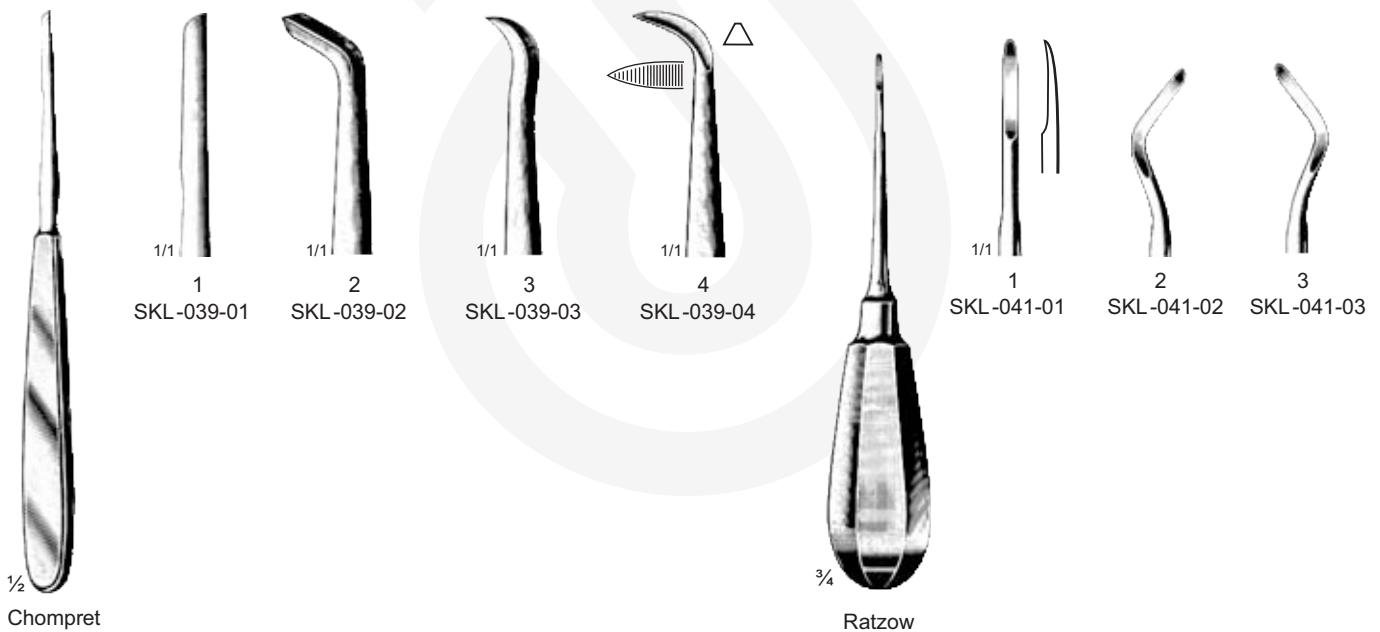
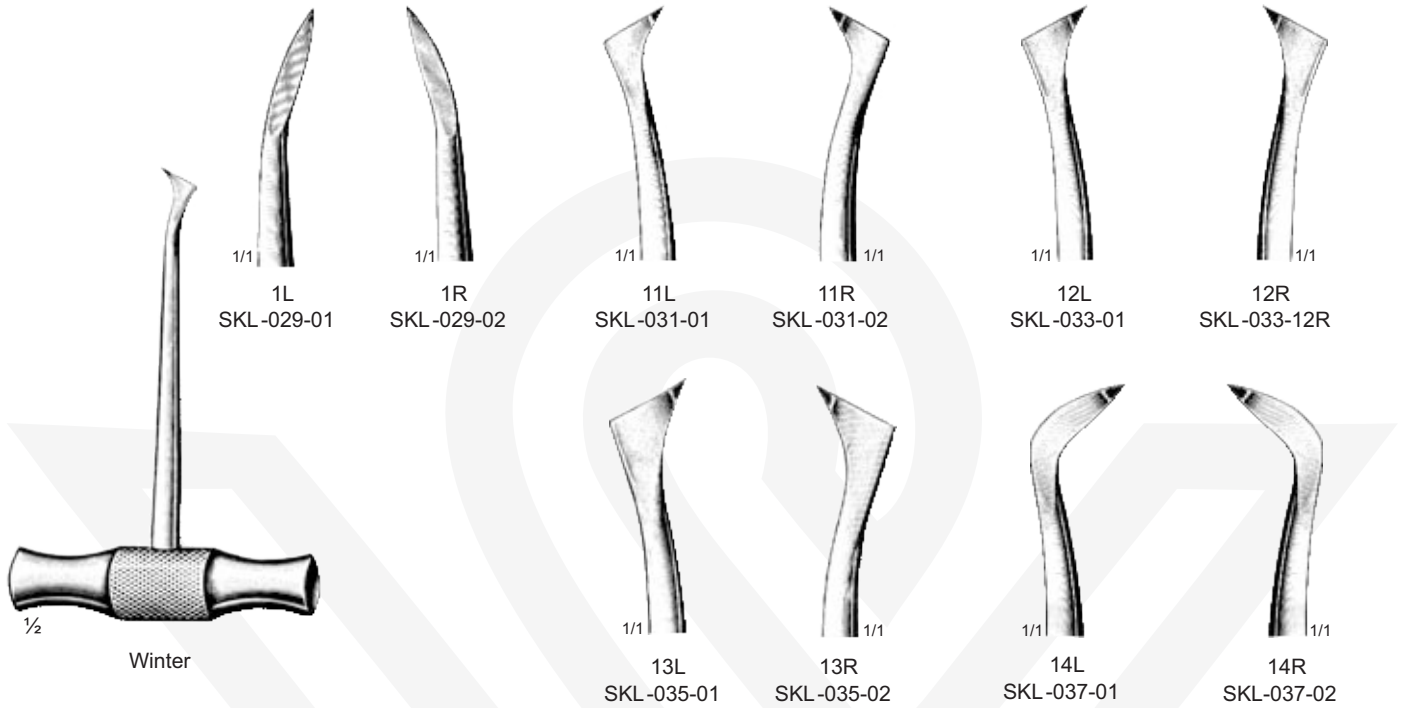



Heidebrink

1/2



Heidebrink
SKL-043-01

1/1



Heidebrink
SKL-045-02

1/1



Heidebrink
SKL-047-03

1/1



Heidebrink
SKL-049-00

1/2



SKL-049-01
SKL-051-01

1/1

1



SKL-049-02
SKL-051-02

1/1

2



SKL-049-03
SKL-051-03

1/1

3



Heidebrink
SKL-051-00

1/2

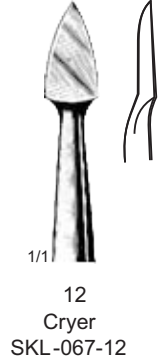
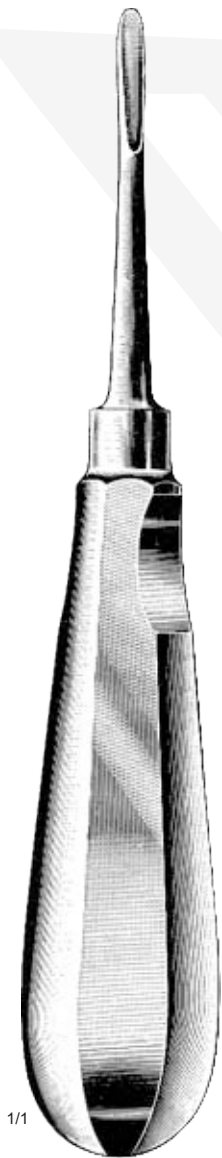
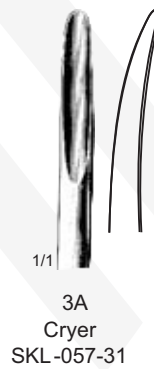
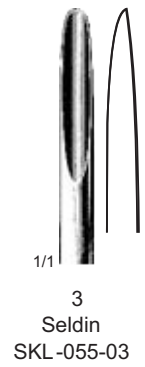
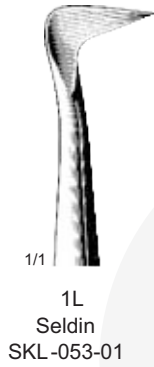

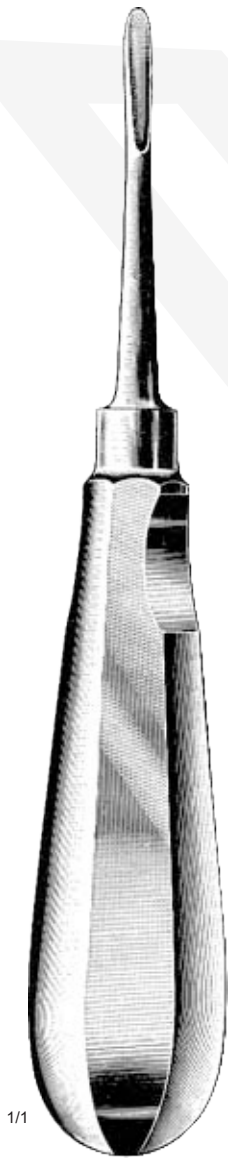

1/1

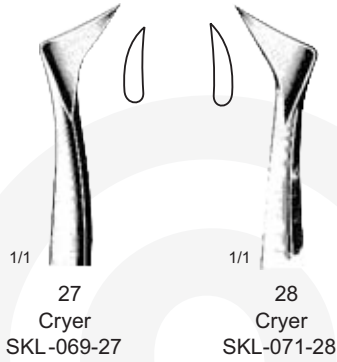

1/1
27
Cryer
SKL-069-27

1/1
28
Cryer
SKL-071-28

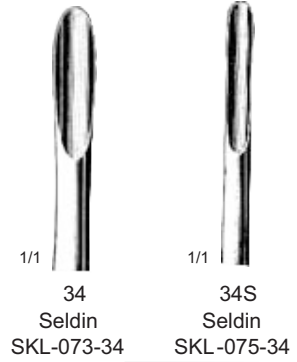

1/1
34
Seldin
SKL-073-34

1/1
34S
Seldin
SKL-075-34



1/1
39
Cryer
SKL-077-39



1/1
40
Cryer
SKL-079-40



1/1
46
SKL-081-46

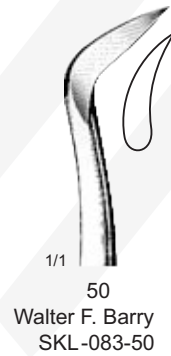

1/1
50
Walter F. Barry
SKL-083-50



1/1
51
Walter F. Barry
SKL-085-51



1/1
301
Apical
SKL-087-01



1/1
302
Apical
SKL-089-02



1/1
303
Apical
SKL-091-03



1/1
304
Apical
SKL-093-04

SKKYLINE

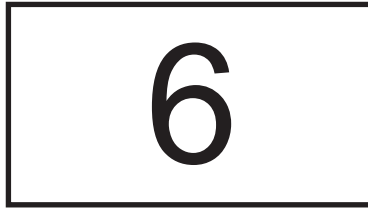
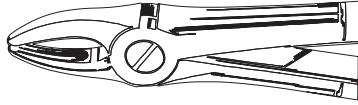

EXTRACTING FORCEPS



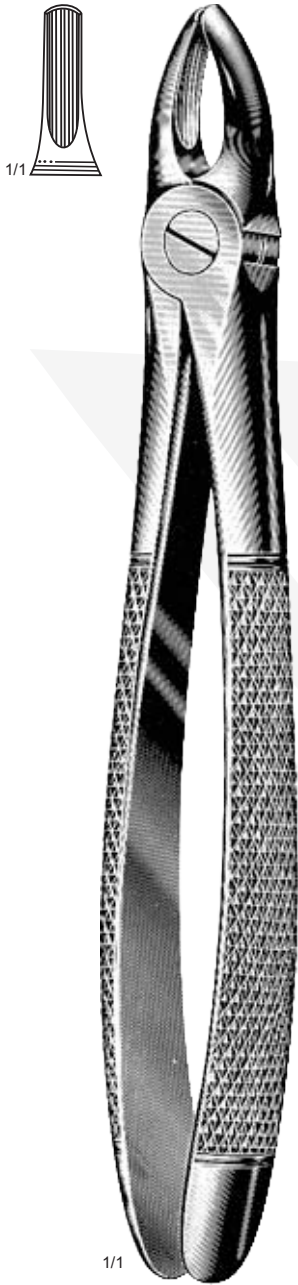

1
SKL-001-01
For Upper Centrals and Canines

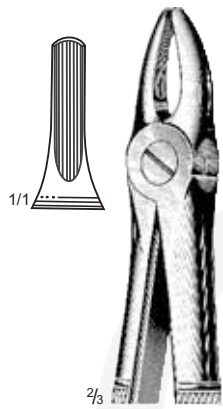

2
SKL-003-02
For Upper Laterals and Bicuspids

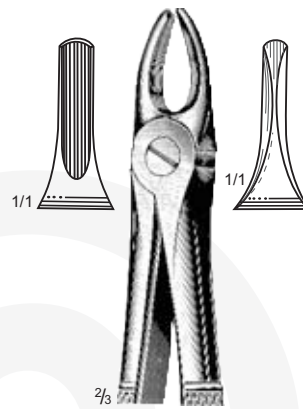

3
SKL-005-03
For Upper Incisors and Canines
Crowned Internally & Externally

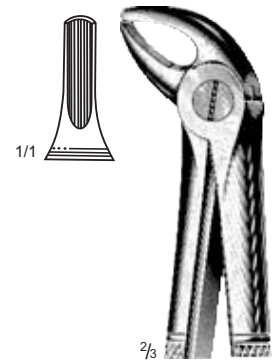

4
SKL-007-04
For Lower Incisors and Canines

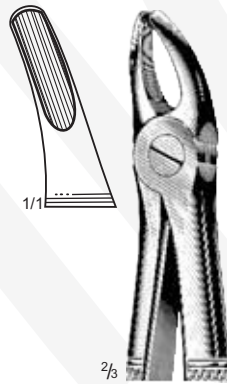

7
SKL-009-07
For Upper Bicuspids, either side

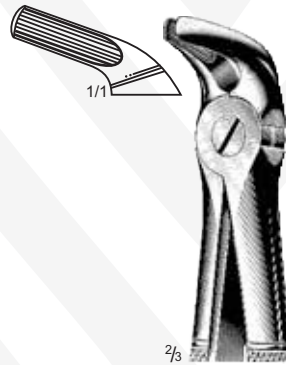

8
SKL-011-08
For Lower Bicuspids, either side

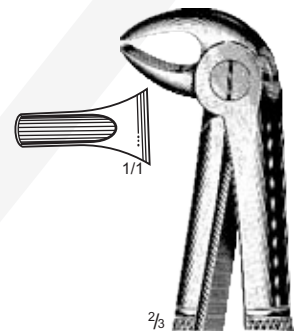

13
SKL-013-13
For Lower Bicuspids, either side

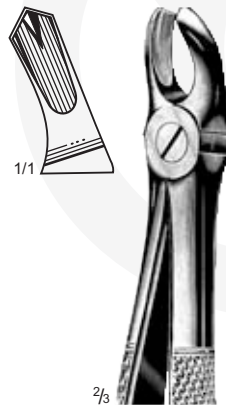

17
SKL-015-17
For Right Upper Molars

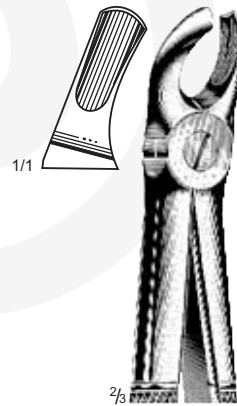

18
SKL-017-18
For Left Upper Molars

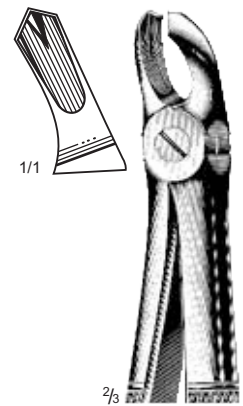

18A
SKL-019-18
For Upper Molars-either side

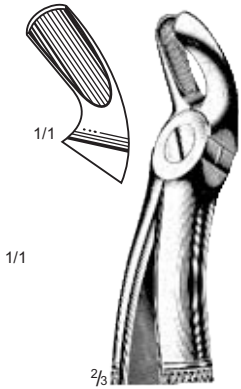

19
SKL-021-19
For Upper Wisdoms-either side

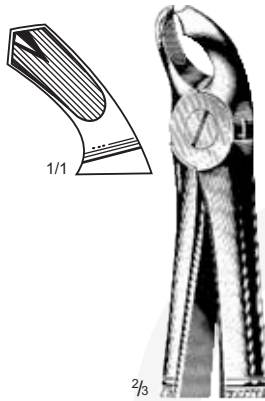

20
SKL-023-20
For Lower Wisdoms-either side

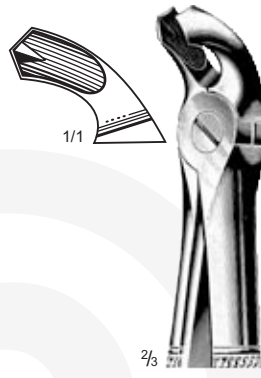

21
SKL-025-21
For Lower Molars-either side

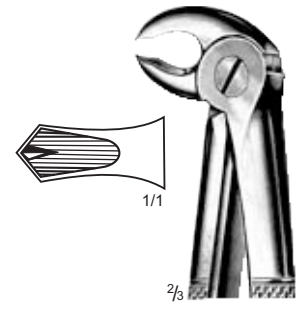

22
SKL-027-22
For Lower Molars-either side

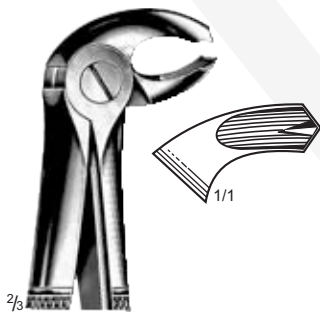

23
SKL-029-23
For Right Lower Molars

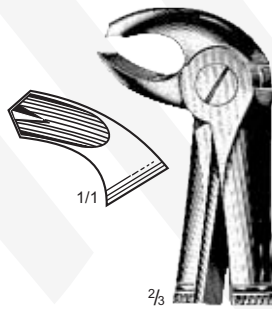

24
SKL-031-24
For Left Lower Molars

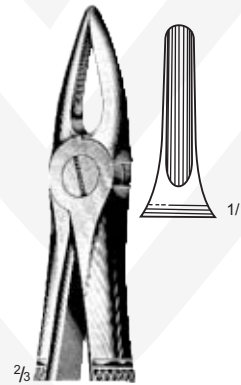

29
SKL-033-29
For Upper Roots and Incisors-either side

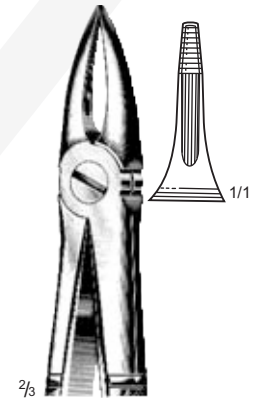

29N
SKL-035-29 For
Roots of Upper Incisors

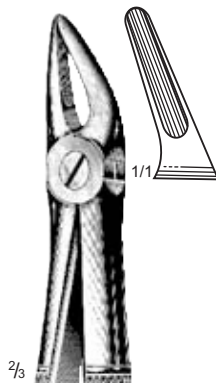

30
SKL-037-30
For Upper Roots and Incisors-either side

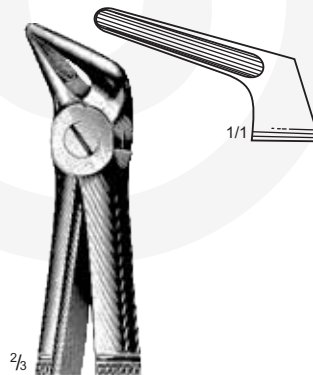

31
SKL-039-31 For
Lower Roots-either side

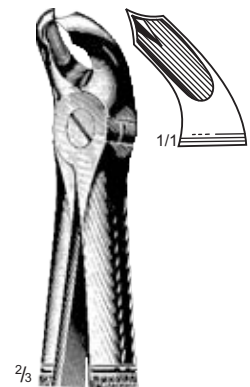

32
SKL-041-32



1/1

Solid No.3
SKL-015-03



1/1

Solid No.3
SKL-017-03



1/1

Solid No.4
SKL-019-04



1/1

Solid No.4-3
SKL-021-43



1/1

Solid No.7
SKL-023-07



1/1

Solid No.7K
SKL-025-07

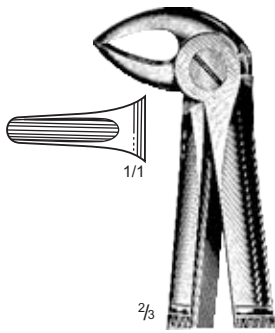

33
SKL-043-33

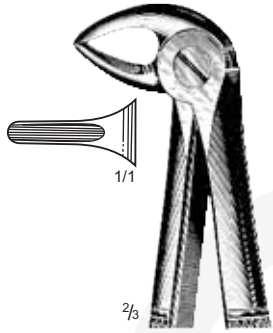

33A
SKL-045-33

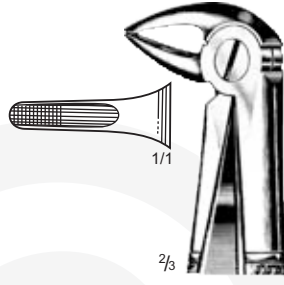

33C
SKL-047-33

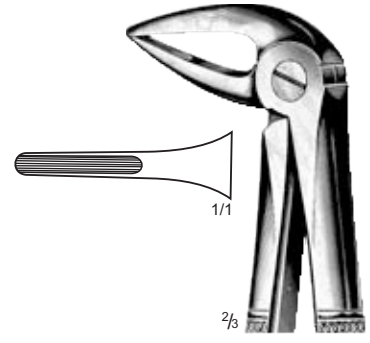

33M
SKL-049-33

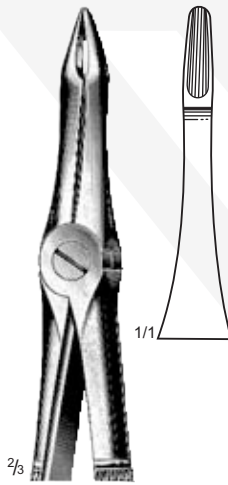

41
SKL-051-41

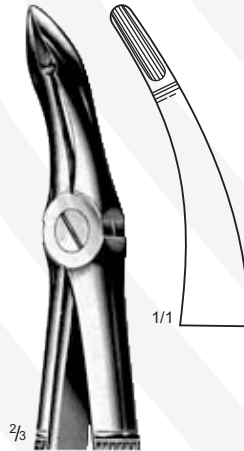

44
SKL-053-44

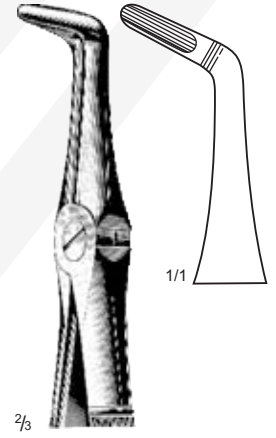

45
SKL-059-45

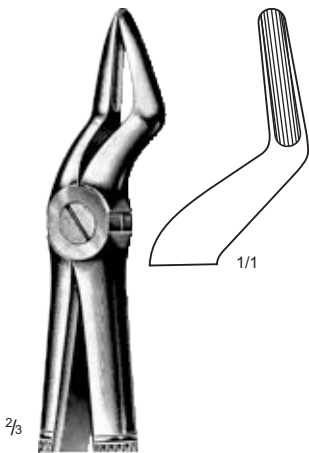

51
SKL-055-51

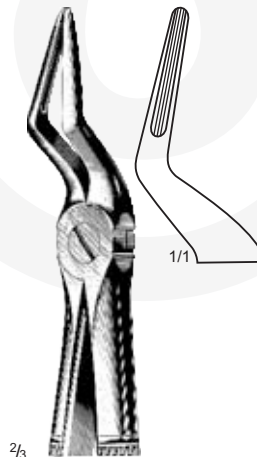

51A
SKL-061-51

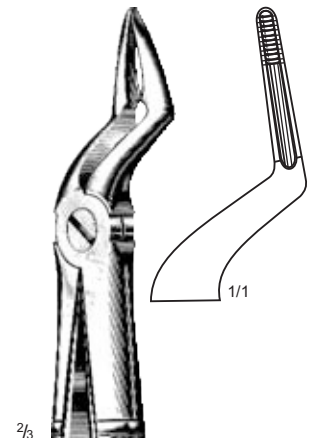

51C
SKL-057-51

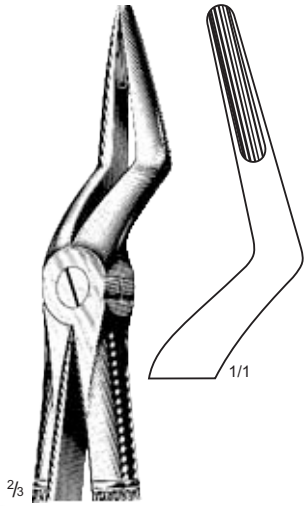

51M
SKL-063-51
For Deep Upper Roots

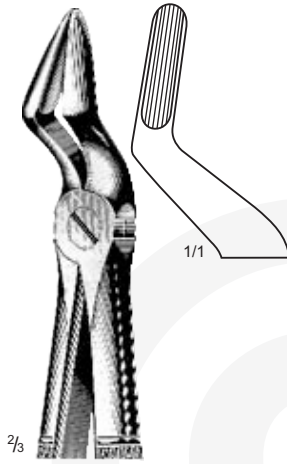

52
SKL-069-52
For Upper Roots and Canines

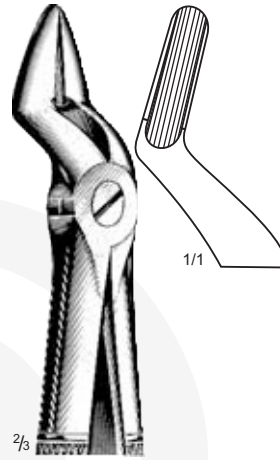

52A
SKL-065-52
For Upper Teeth and Resection-either side

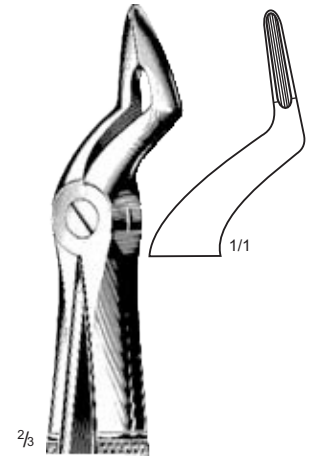

53 Witzel
SKL-071-53
For Upper Roots

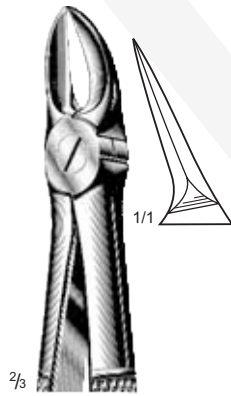

55
SKL-067-55
For Separating Upper Molar Roots

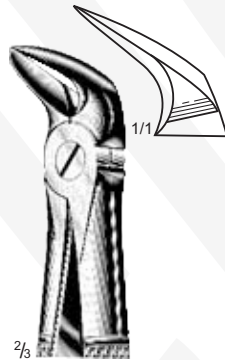

56
SKL-073-56
For Separating Lower Molar Roots

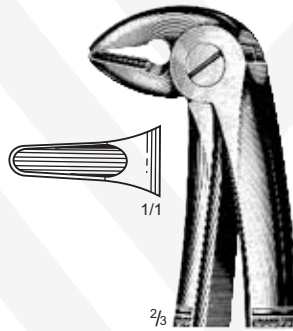

59
Busch
SKL-075-59
Resection Forceps for Lower Roots

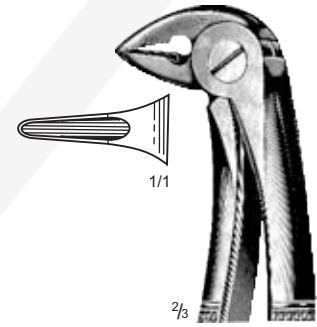

60
Busch
SKL-077-60
Resection Forceps for Lower Roots

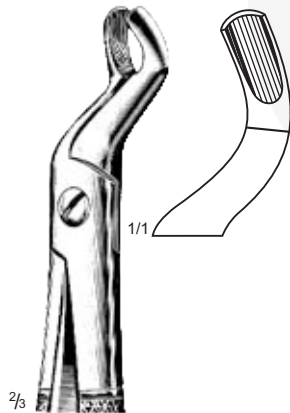

67
SKL-079-67
For Upper Wisdoms, either side

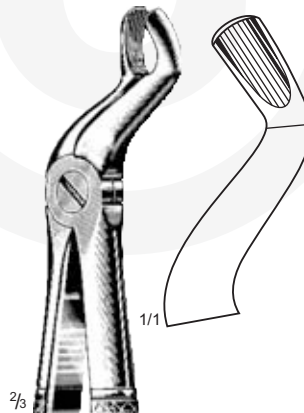

67A
SKL-081-67
For Upper Wisdoms, either side

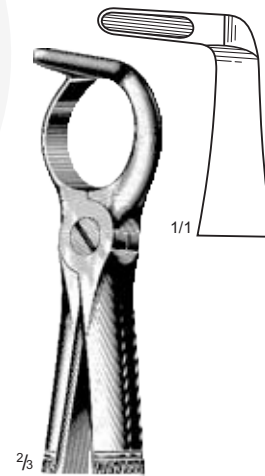

68
SKL-083-68 For
Lower Roots, either side



73
SKL-085-73



74
SKL-087-74



74M
SKL-089-74

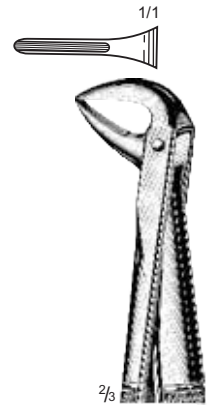

74N
SKL-091-74

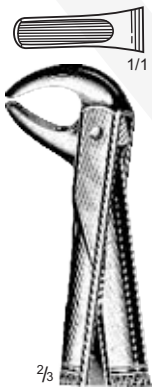

75
SKL-093-75

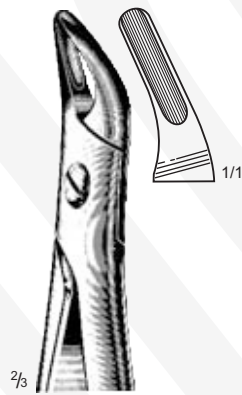

76
Lawrence read
SKL-095-76



76N
Lawrence read
SKL-097-76

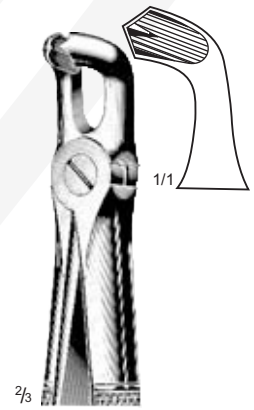

79
SKL-099-79

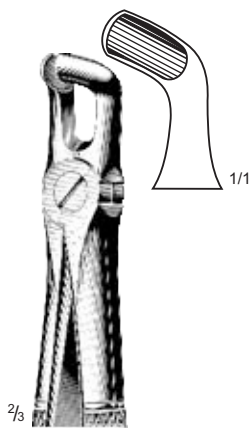

79A
SKL-103-79
For Lower Wisdoms
either side



86A
SKL-105-86
For Lower Molar with decayed or
broken-down crown, either side



86B
SKL-107-86
For Lower Molar with decayed or
broken-down crown, either side



86C
SKL-109-86
For Lower Molar with decayed or
broken-down crown, either side

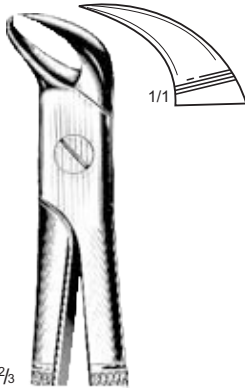

87
SKL-111-87
For Lower Molar with decayed or broken-down crown, either side

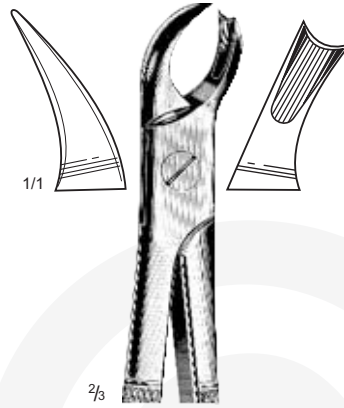

89
SKL-113-89
For Right Upper Molar

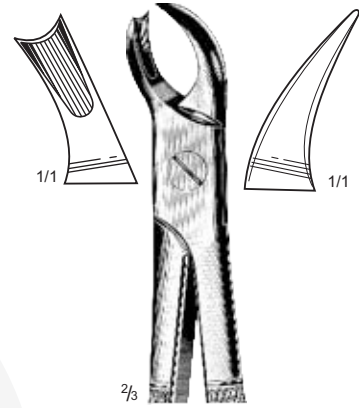

90
SKL-115-90
For Left Upper Molar

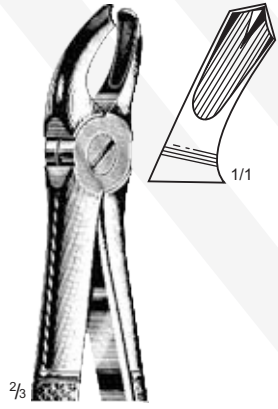

94
SKL-117-94
For Right Upper Molar

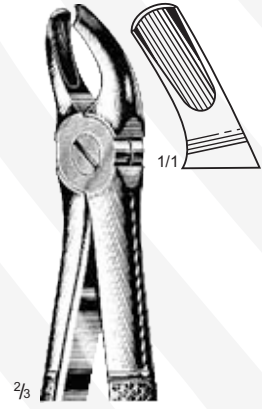

95
SKL-119-95
For Left Upper Molar



99
Wood
SKL-121-99
For Broken-Down Lower Molar either side



99¼
Passow
SKL-123-99
For Broken-Down Lower Molar either side

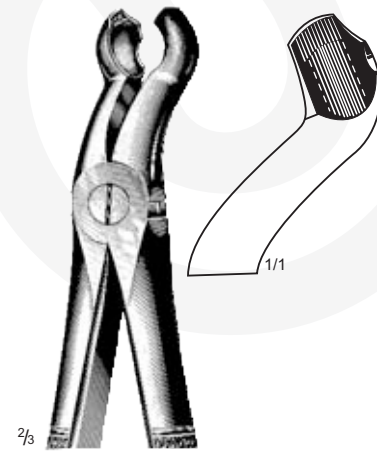

121
Ogden-Felsch
SKL-125-21
For Upper Wisdoms

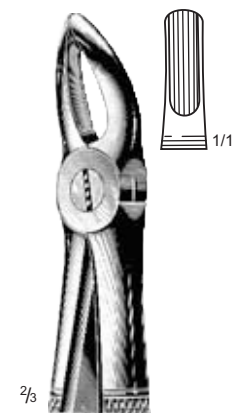

136
Guy
SKL-127-36
For Upper Centrals and Roots



137
Guy
SKL-129-37
For Lower Centrals and Roots

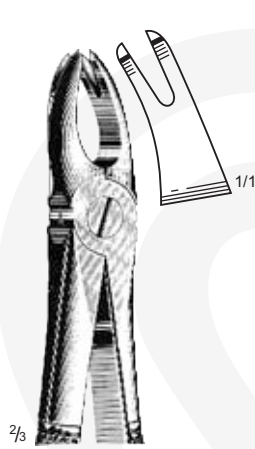

166
Trotter
SKL-131-66 For
Upper Teeth, Bicuspids



167
Trotter
SKL-133-67 For
Lower Teeth, Bicuspids

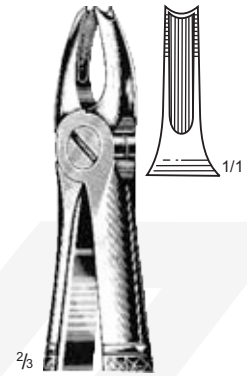

168
Trotter
SKL-135-68
For Upper Canines



169
Trotter
SKL-137-69
For Lower Canines and, Bicuspids



233
SKL-139-33
For Lower Roots

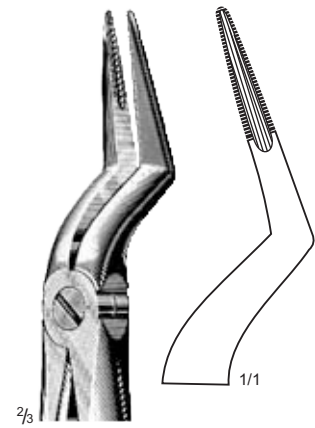

235
SKL-141-35
For Upper Roots



1
SKL-149-01
For Upper Central and Canines

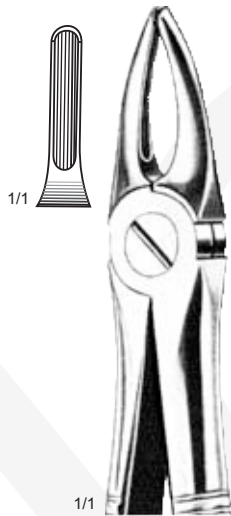

2
SKL-143-02
For Upper Laterals
and Bicuspids

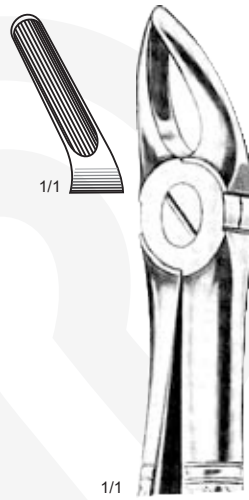

7
SKL-145-07
For Upper Bicuspid
either side

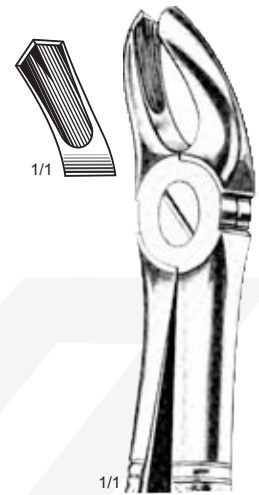

17
SKL-147-17
For Right Upper Molars

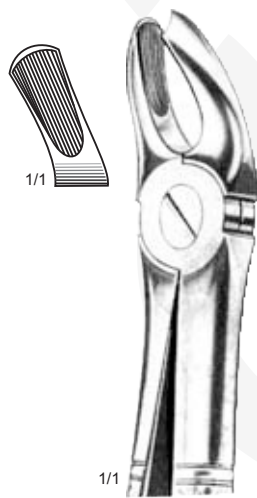

18
SKL-151-18
For Left Upper Molars

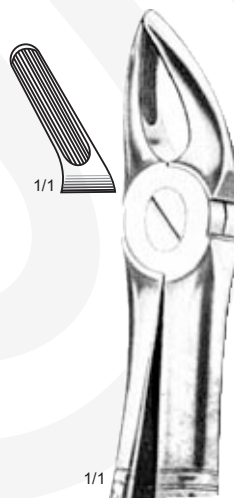

30
SKL-153-30
For Upper Incisors and Roots
either side

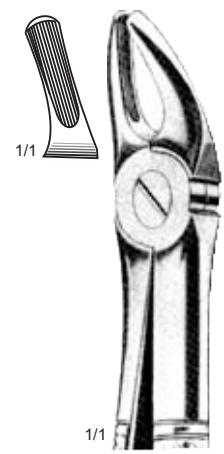

39
SKL-155-39
For Upper Molars
either side

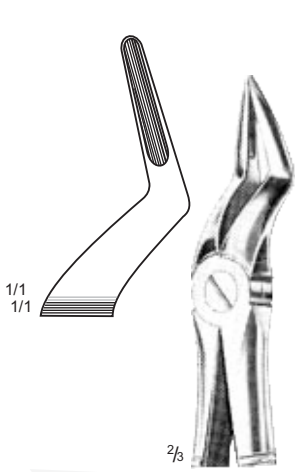

51
SKL-157-51
For Upper Roots

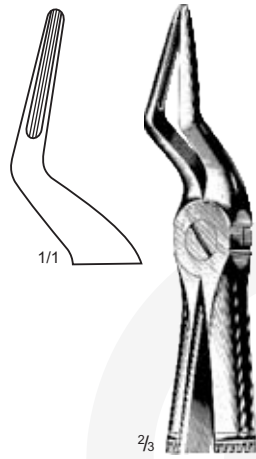

51A
SKL-159-51
For Upper Roots

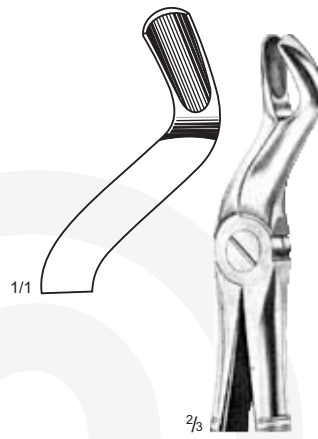

67A
SKL-161-67
For Upper Wisdoms, either side

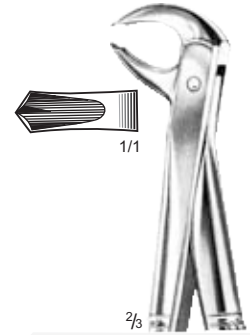

73
SKL-163-73
For Lower Molars-either side

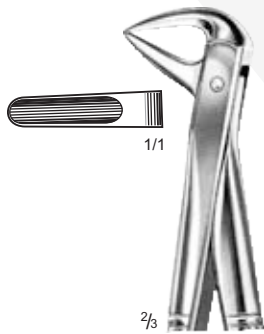

74
SKL-165-74
For Lower Incisors and Roots-either side

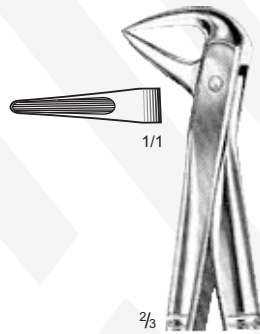

74N
SKL-167-74
For Lower Incisors and Roots

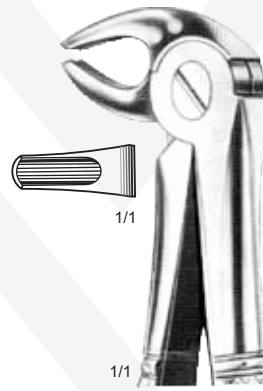

13
SKL-169-13
For Lower Bicuspid-either side

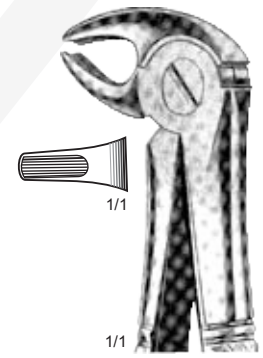

13S
SKL-171-13
For Lower Bicuspid-either side

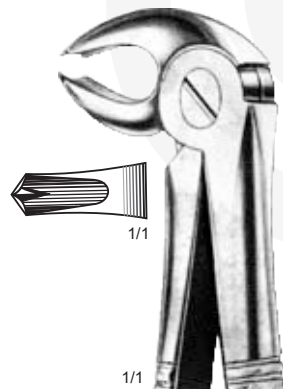

22
SKL-175-22
For Lower Molars-either side

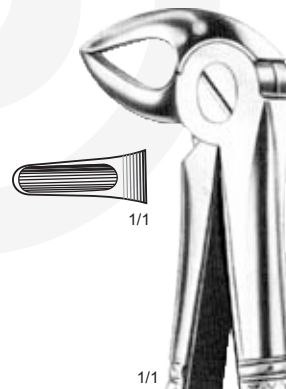

33
SKL-177-33 For
Lower Roots-either side

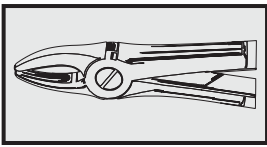

37
SKL-179-37
For Upper Incisors and Canines



13S
SKL-173-13
For Lower Bicuspids

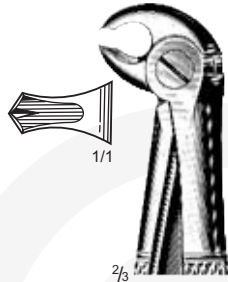

22S
SKL-181-22
For Lower Molars-either side

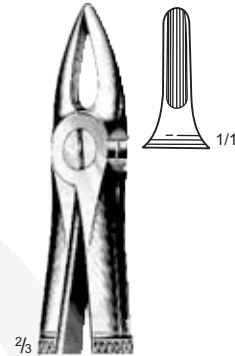

29S
SKL-183-29
For Upper Incisors and roots-either side

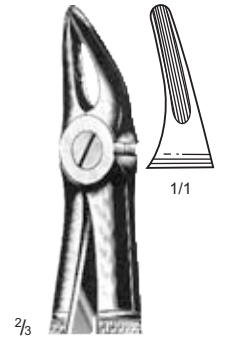

30S
SKL-185-30
For Upper Incisors and roots-either side



33S
SKL-187-33
For Lower roots-either side

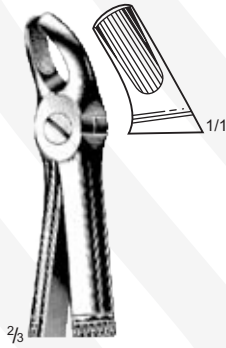

39
SKL-189-39
For Upper Molars-either side

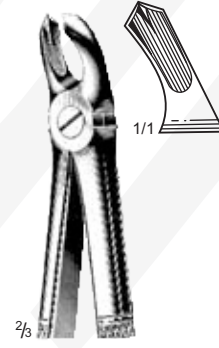

39A
SKL-191-39
For Upper Molars-either side

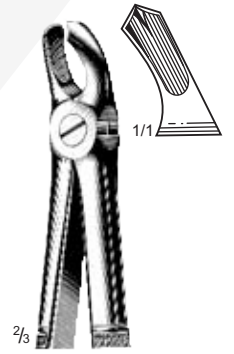

39L
SKL-193-39
For Left Upper Molars

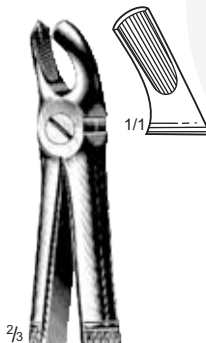

39R
SKL-195-39
For Right Upper Molars

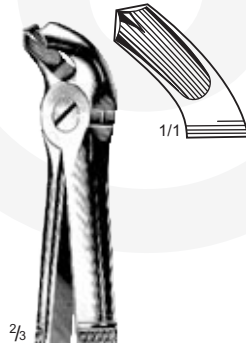

40
SKL-197-40
For Lower Molars-either side

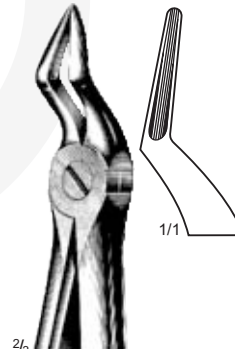

51S
SKL-199-51
For Upper Roots

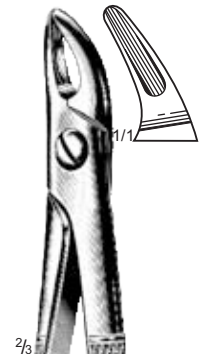

76S
SKL-201-76
For Upper Roots-either side

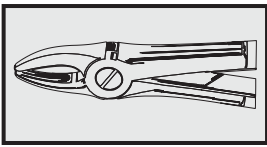

MD1
SKL-203-01
For Upper Wisdoms and Bicuspid
and upper Roots
Mead



MD2
SKL-205-02
For Upper Molars
Mead

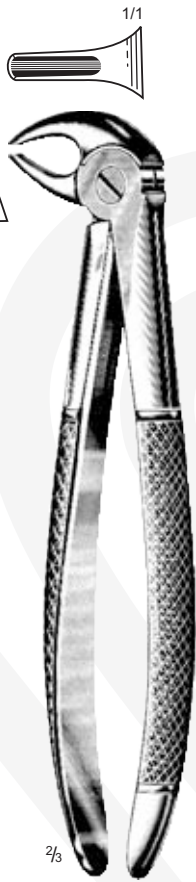

MD3
SKL-207-03 For
Lower Incisors Bicuspid and
Roots

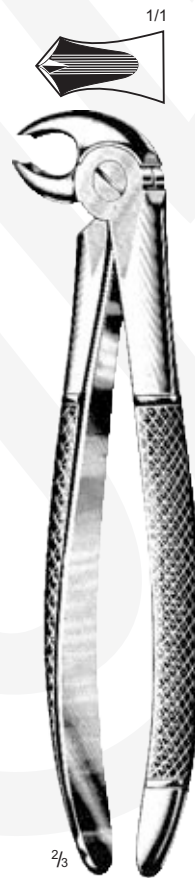

MD4
SKL-209-04
For Lower Molars

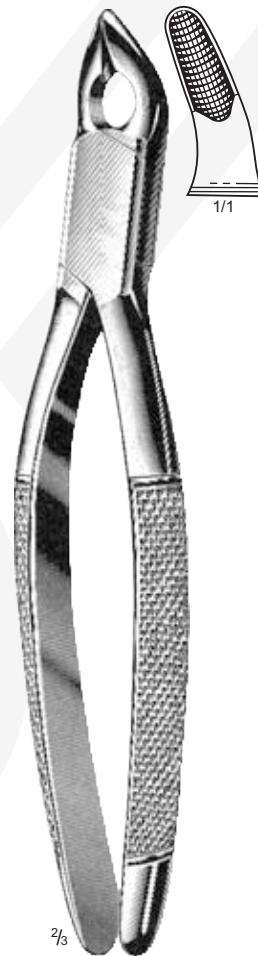

Cohen
SKL-211-00
Universal Forceps
American Pattern

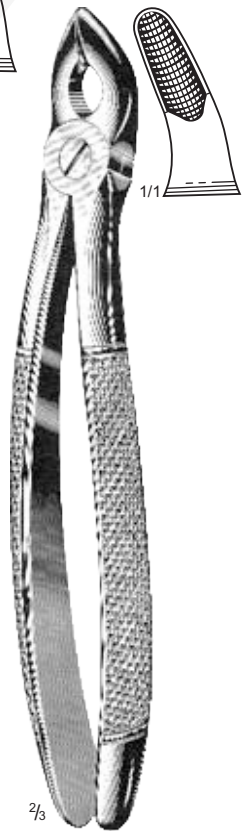

Cohen
SKL-213-00
Universal Forceps
English Pattern

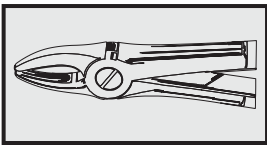

1/1
Stiksa
SKL-215-00
For Lower Wisdoms and Molars-either side

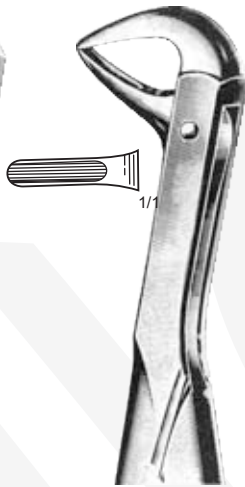

1/1
Stiksa
SKL-217-00
For Roots of Lower Molars and Wisdoms
either side

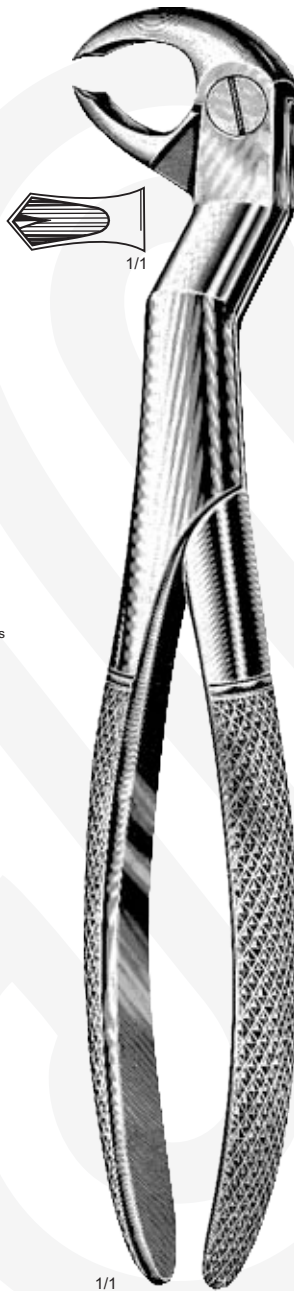

1/1
22 1/2 L
Wisdom-Routurier
SKL-219-22
For Left Lower Wisdoms and Molars



1/1
22 1/2 R
Wisdom-Routurier
SKL-221-22
For Right Lower Wisdoms and Molars

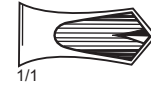



1/1

Lancette
13 cm / 5"
SKL-027-13



2/1



1/1

Collin
No. 8
SKL-029-08
Hollow



1/1

Collin
No. 9
SKL-031-09
Hollow



1/1

No. 10
SKL-033-10
Hollow



1/1

Williger
3.5 cm / 1½" (Blad size)
SKL-035-35

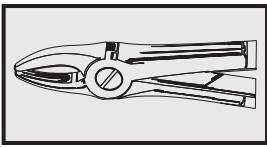

5
Klein
SKL-225-05
For Lower Incisors

6
Klein
SKL-227-06
For Lower Molars

7
Klein
SKL-229-07
For Lower Roots



3
Klein
SKL-223-03
For Upper Molars



137
Klein
SKL-231-37
For Upper Incisors and Canines



139
Klein
SKL-233-39
For Upper Bicuspids

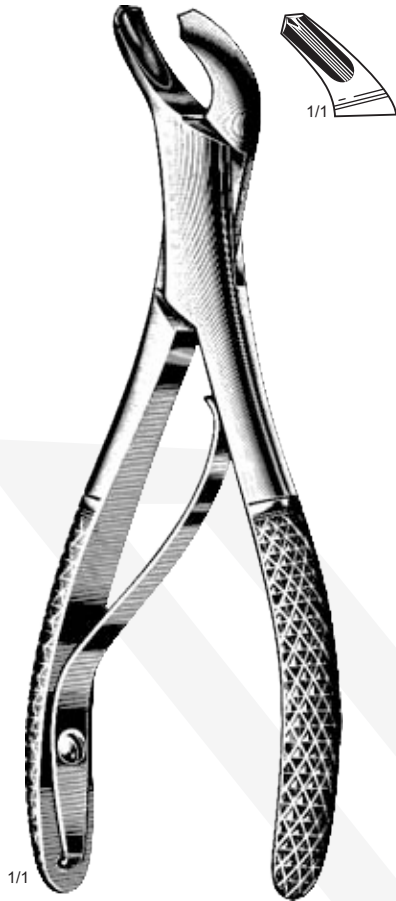
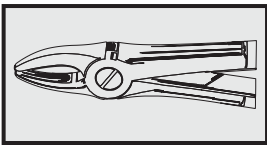

17SK
SKL-235-17
For Lower Molars-either side



23SK
SKL-237-23
For Lower Molars-either side

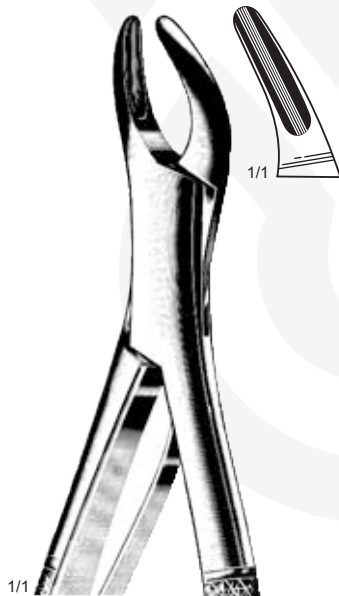

150SK
SKL-239-50 For
Upper Teeth and Roots

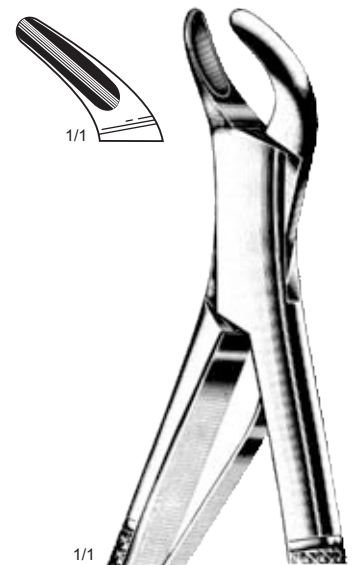

151SK
SKL-241-51 For
Lower Teeth and Roots

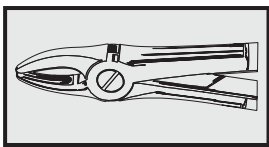

1
Standard
SKL-243-01
For Upper Central, Laterals and Cuspid

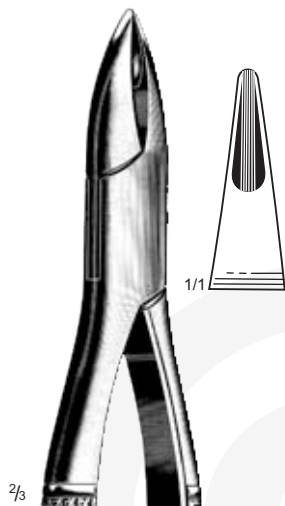

1A
Henahan
SKL-245-11
For Upper Incisors

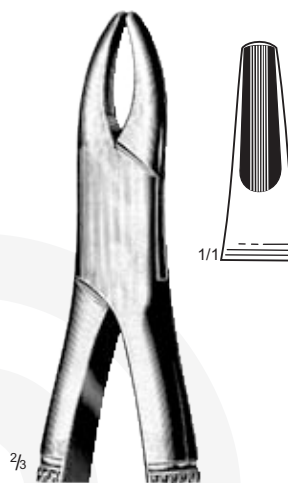

1B
Normal
SKL-249-12
For Upper Front Roots

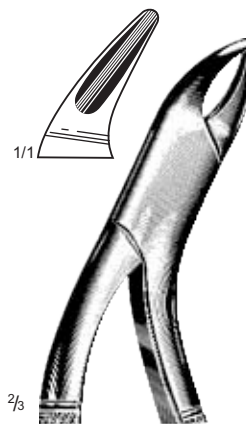

3
Milwaukee
SKL-247-03
For Lower Bicuspids

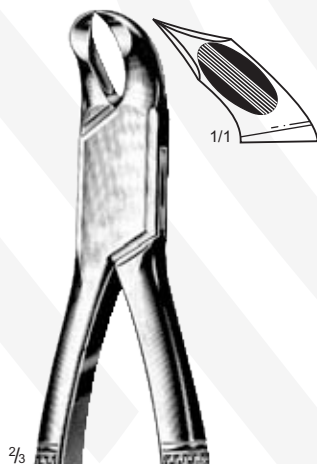

3FS
Woodward
SKL-251-03
For Lower Molars for
straight handles



3FH
Woodward
SKL-253-03
For Lower Molars with
hooked handles

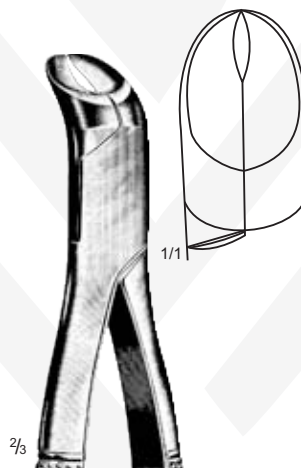

5
Physick
SKL-255-05
For Lower Third
Molars-either side

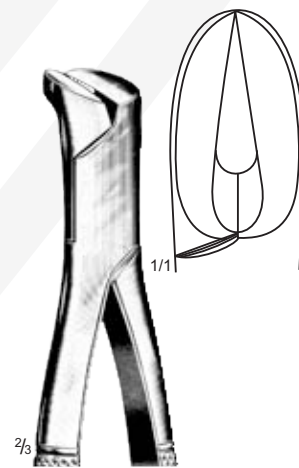

6
SKL-257-06 Splitting
or Separating Forceps

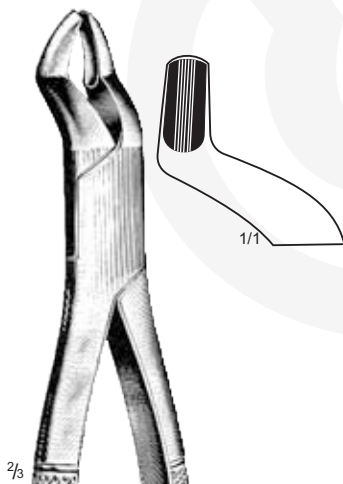

10H
SKL-259-10
For Upper Molars with
hooked handles



10S
SKL-261-10
For Upper Molars with
straight handles

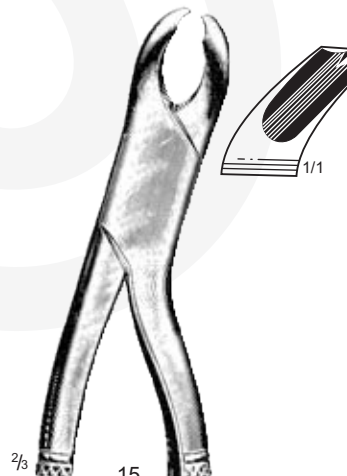

15
Harris
SKL-263-15
For Lower Molars for either-side
with hooked handles

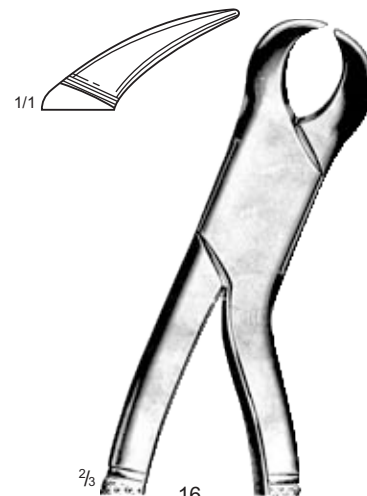

16
SKL-265-16
For Lower Molars

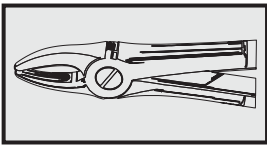

16S
SKL-267-16
For Lower Molars-either side, for children
with hooked handle



17
SKL-269-17
For Lower Molars-either side
with straight handle

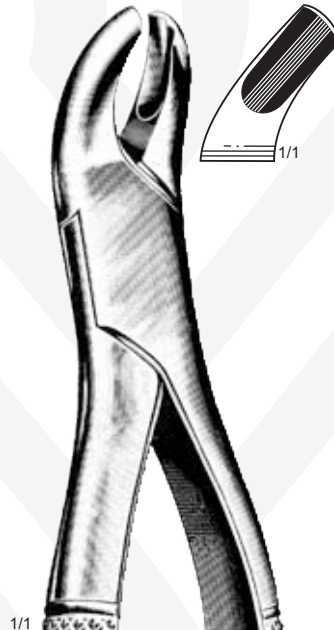

18L
SKL-271-18 For
Upper Molars, Left Side,
with hooked handle

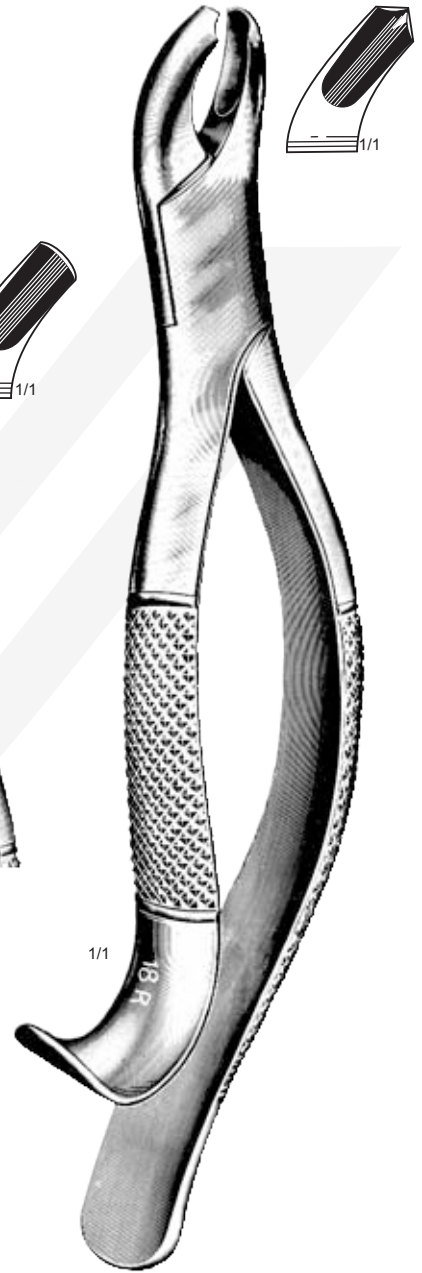

18R
SKL-273-18 For
Upper Molars, right side
with hooked handle

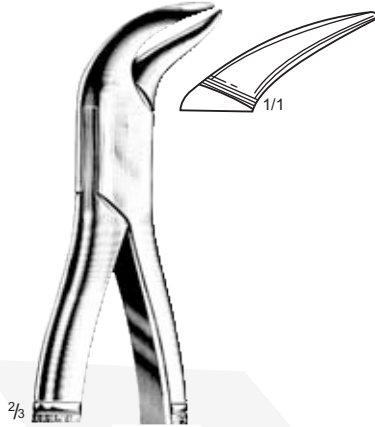
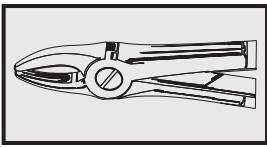

23
SKL-275-23
For Lower Molars-either side
with straight handle

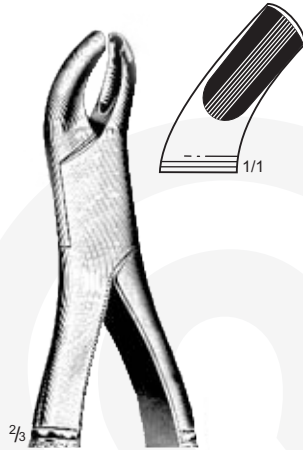

24
SKL-277-24
For Upper Molars-either side
hooked handle

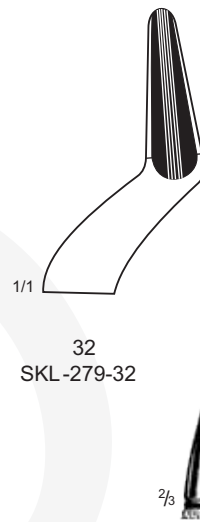

32
SKL-279-32
For Upper Molars and Bicuspid
with straight handle



32A
SKL-281-32
Parmlly
For Upper Molars and Bicuspid
with straight handle

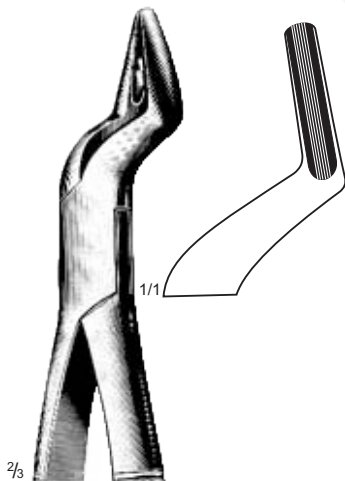

35
SKL-283-35 For
Upper Roots-either side
with straight handle

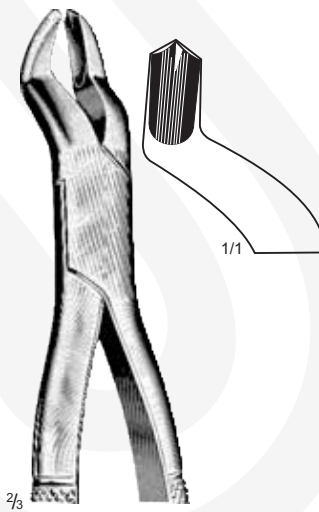

53L
SKL-285-53
For Upper Molars, Left side, with
straight handle

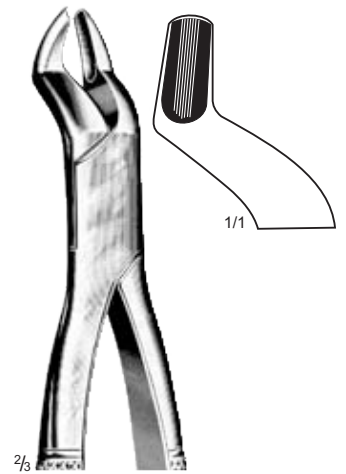

53R
SKL-287-53
For Upper Molars, right side, with
straight handle

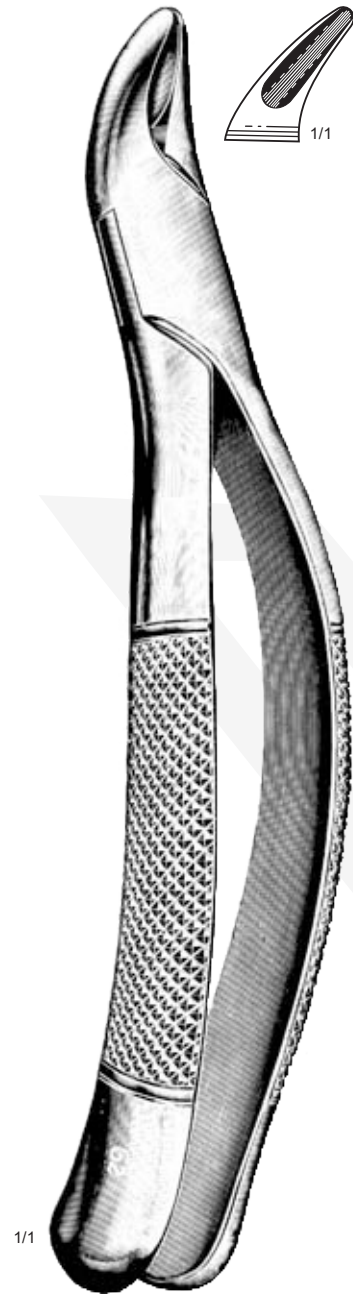
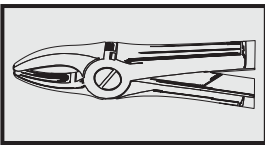

62
SKL-289-62
Universal Forceps, For Upper Teeth and Roots,
For Children, straight handle

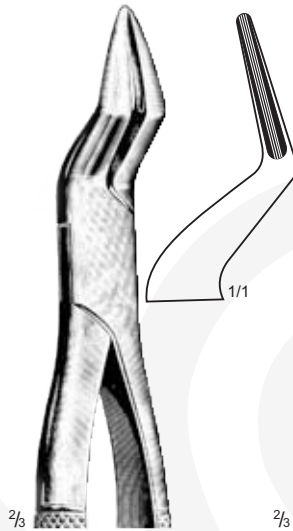
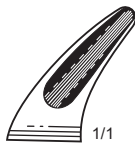

65
SKL-291-65
For Upper Incisors and Roots
Straight handle

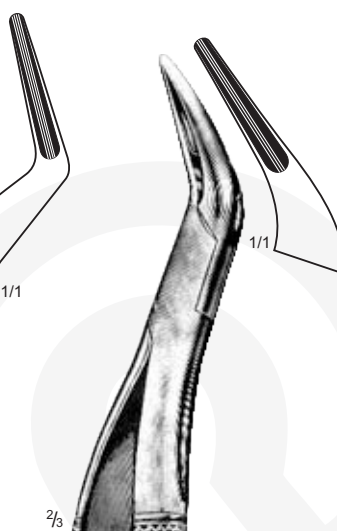

69
SKL-293-69
For Fragments and Small Roots, upper
and lower straight handle

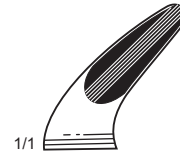

85
SKL-295-85
For Lower Molars, Cuspids
and Bicuspids
with hooked handle

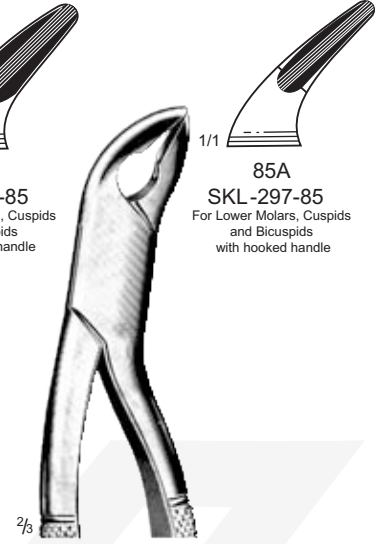

Thomas



85A
SKL-297-85
For Lower Molars, Cuspids
and Bicuspids
with hooked handle

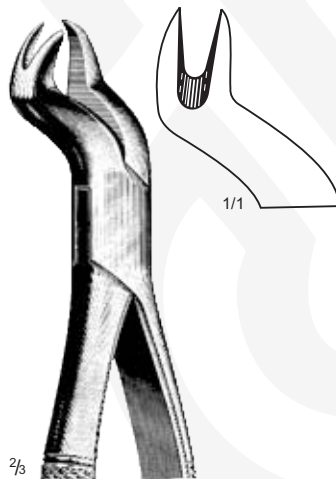

88L
SKL-299-88 For
Left Upper Molars, with
straight handle

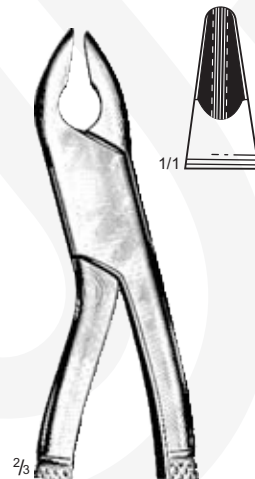

99A
Kells
SKL-301-99
For Upper Bicuspids, and Incisors
with hooked handle

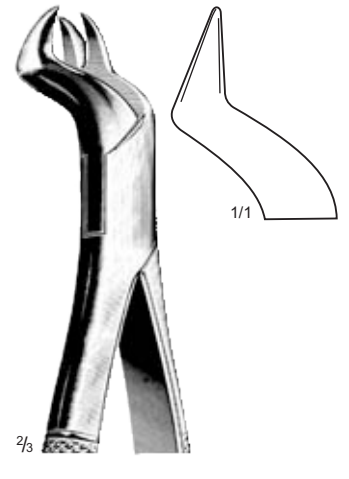

88R
SKL-303-88
For Right Upper Molars, with
straight handle

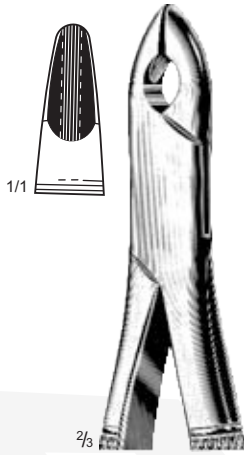
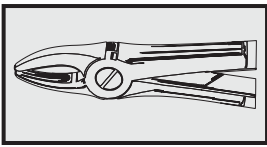

**99C
Kells**
SKL-305-99
For Upper Bicuspids, and Incisors
with straight handle

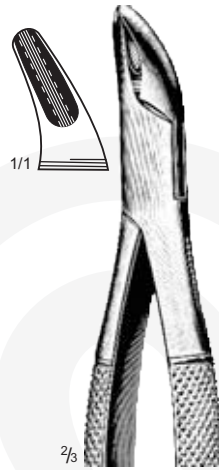

**101
Hull**
SKL-307-101
Universal Forceps for Bicuspids,
and Milk-Teeth, straight handle

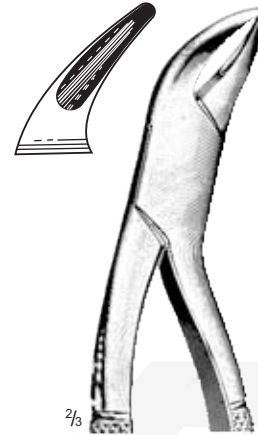

103
SKL-309-03
For Lower Bicuspids, Incisors and Roots-either
side hooked handle

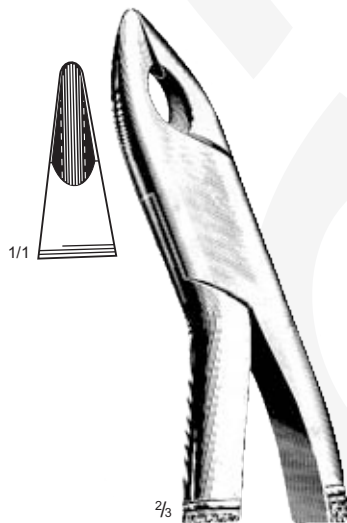

**110
Nevius**
SKL-311-10
For Upper Bicuspids and Cuspids
with hooked handle

SKL-313-01
For Upper Bicuspids and Cuspids
with straight handle

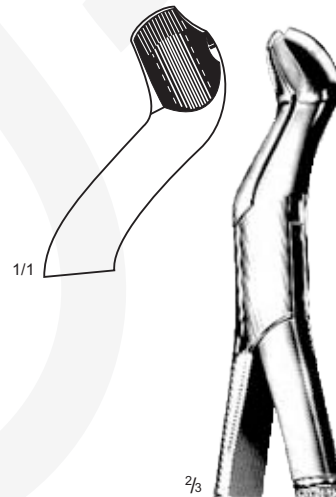

**121
Felsch**
SKL-315-21
For Upper Wisdoms with
straight handle

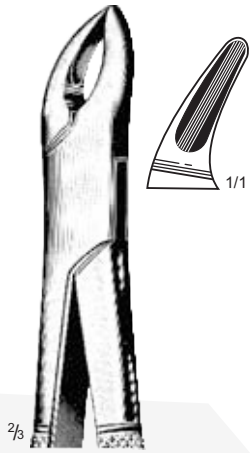
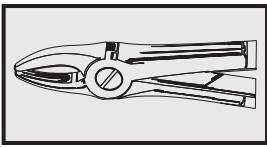

**150
Cryer**
SKL-317-50
For Upper Bicuspids Incisors and
Roots with straight handles

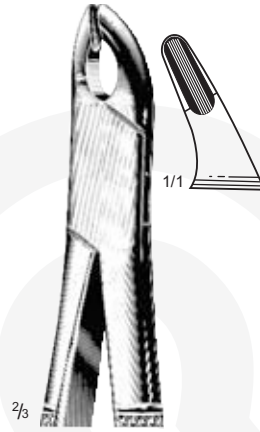

**150A
Cryer**
SKL-319-50
For Upper Bicuspids Incisors and
Roots with straight handle

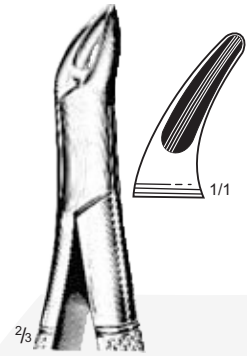

**150S
Cryer**
SKL-321-50
For Upper Bicuspids Incisors and
Roots with straight handle

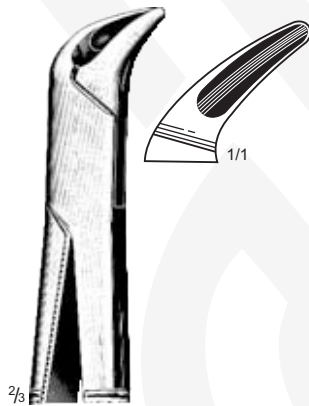

**151
Cryer**
SKL-323-51
For Upper Bicuspids Incisors and
Roots with straight handle

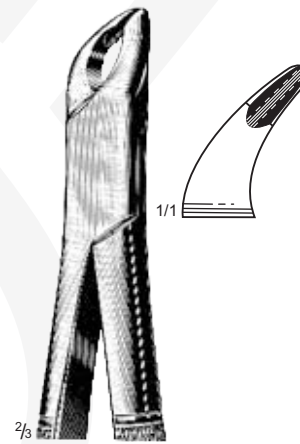

**151A
Cryer**
SKL-325-51
For Upper Bicuspids Incisors and
Roots with straight handle

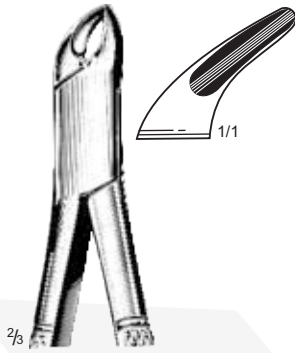
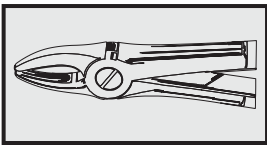

151S
Cryer
SKL-327-51
For Lower Bicusps Incisors and
Roots with straight handle

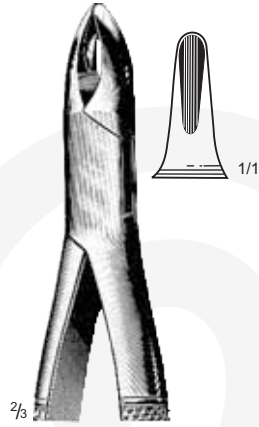

201
SKL-329-01
For Upper Bicusps Cuspids and Incisors
with straight handle

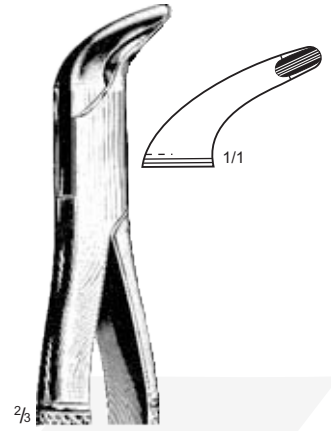

203
SKL-331-03
For Lower Bicusps and Roots Incisors
with straight handle

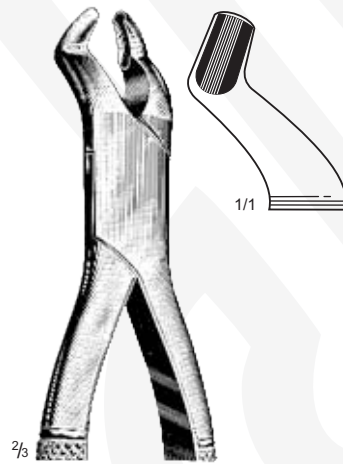

210H
SKL-333-10
For Upper Wisdoms-either side
with hooked handle

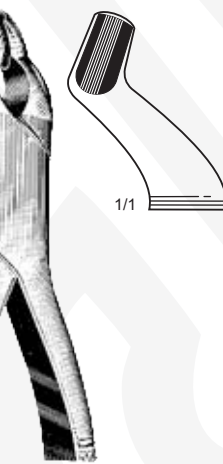

210S
SKL-335-10
For Upper Wisdoms-either side
with straight handle

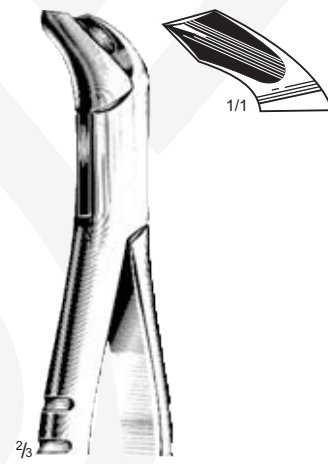

217
SKL-337-17
For Lower Molars-either side
with straight handle

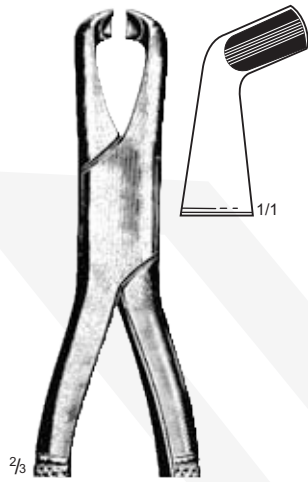
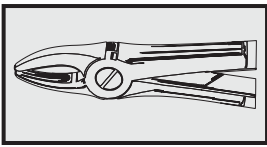

222

SKL -339-22
For Lower Wisdoms-either side,
with straight handle

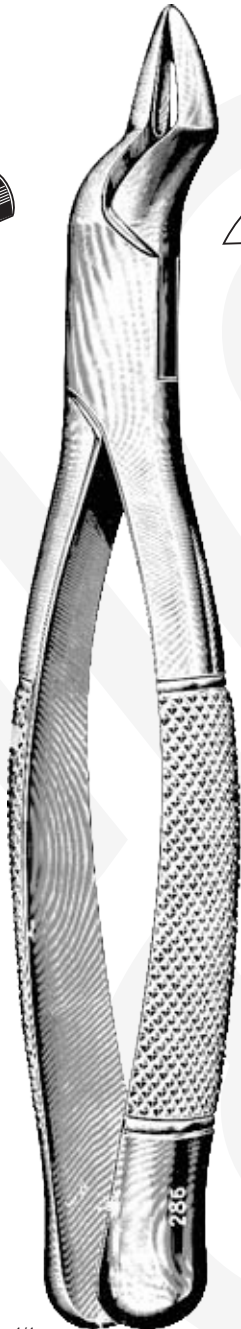

1/1

286

SKL -345-86
For Upper Roots, Bicusps and Incisors-either
side with straight handle

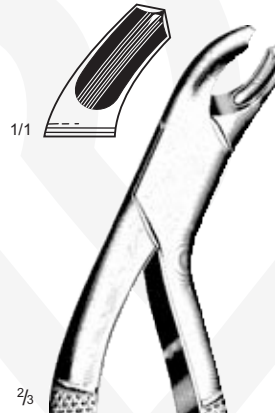

287

Swing

SKL -341-87
For Lower Molars-either side,
with hooked handle

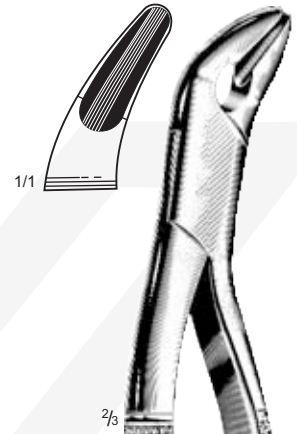

288

SKL-343-88
For Lower Bicusps, Cuspids-either
side with hooked handle

SKKYLINE



Scissors



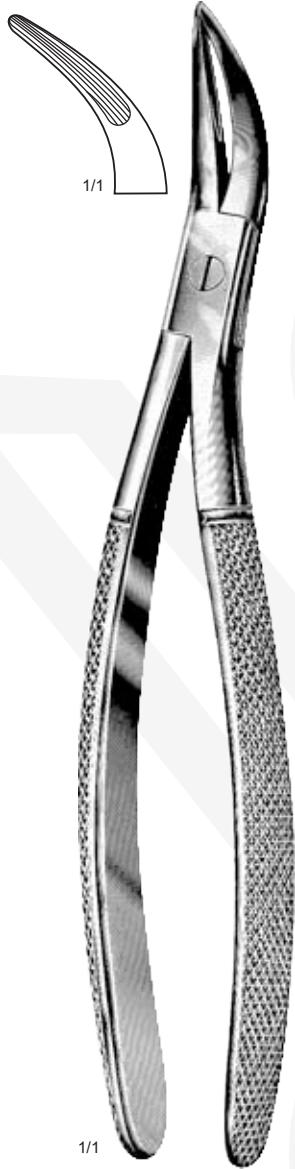
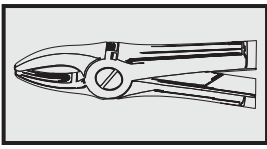

Witzel
SKL-347-00 Universal
Pattern for Upper Teeth]

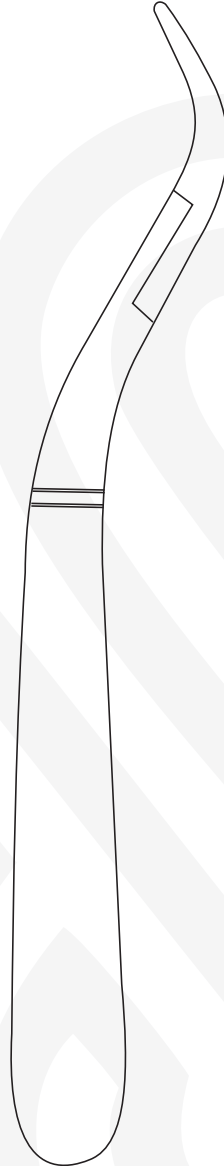

Witzel
SKL-349-00 Universal
Pattern for Upper Teeth]



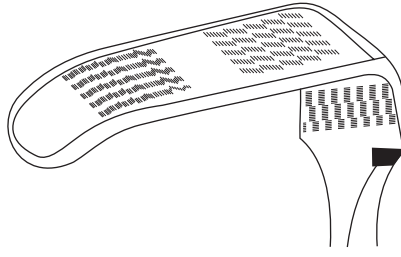

RETRACTORS



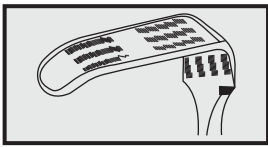

Alm



a = 12 mm
b = 12 mm
c = 35 mm
SKL-009-10
SKL-013-10

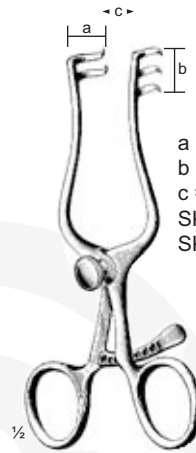

a = 16 mm
b = 18 mm
c = 55 mm
SKL-011-13
SKL-015-13

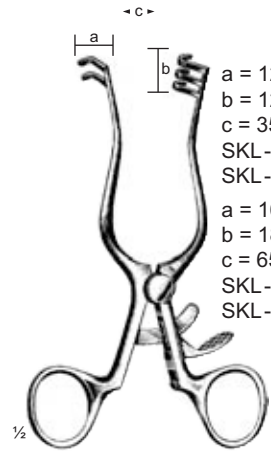

a = 12 mm
b = 12 mm
c = 35 mm
SKL-017-10
SKL-021-10
a = 16 mm
b = 18 mm
c = 65 mm
SKL-019-13
SKL-023-13

cm	in	Sharp	Blunt	Sharp	Blunt	Sharp	Blunt	Sharp	Blunt
7	2 3/4	SKL-001-07	SKL-003-07						
10	4	SKL-001-10	SKL-003-10	SKL-005-10	SKL-007-10	SKL-009-10	SKL-013-10	SKL-017-10	SKL-021-10
13	5					SKL-011-13	SKL-015-13	SKL-019-13	SKL-023-13

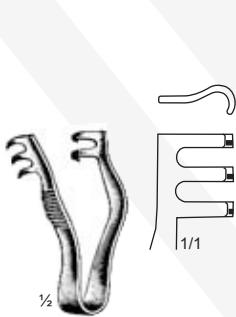

Finsen

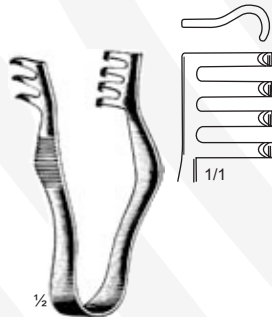

Finsen

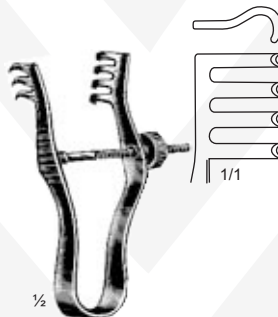

Finsen



Logan

Sharp	Blunt	Sharp	Blunt	Sharp	Blunt	Sharp
5 cm / 2"	5 cm / 2"	7 cm / 2 3/4"	7 cm / 2 3/4"	7 cm / 2 3/4"	7 cm / 2 3/4"	4 cm / 1 1/2"
SKL-025-05	SKL-027-05	SKL-029-07	SKL-031-07	SKL-033-07	SKL-035-07	SKL-037-04

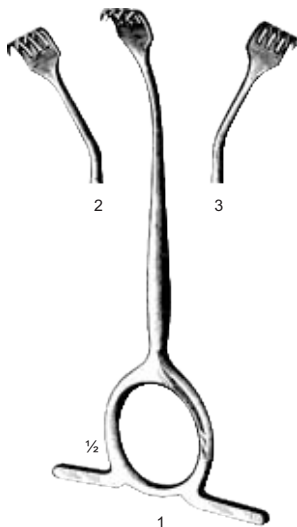

Williger



	Sharp	Blunt
1	SKL-039-03	SKL-045-04
2	SKL-041-03	SKL-047-04
3	SKL-043-03	SKL-049-04
	SKL-051-03	SKL-057-04
	SKL-053-03	SKL-059-04
	SKL-055-03	SKL-061-04

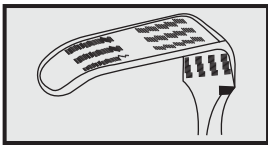

Senn-Green
15 cm / 6"

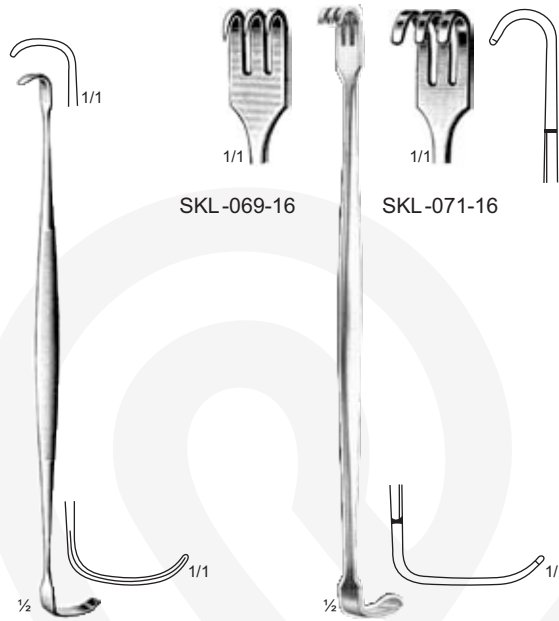

Ragnell-Davis
14 cm / 5½"
SKL-067-14

Senn-Mueller
16 cm / 6¼"



Klapp
16 cm / 6¼"

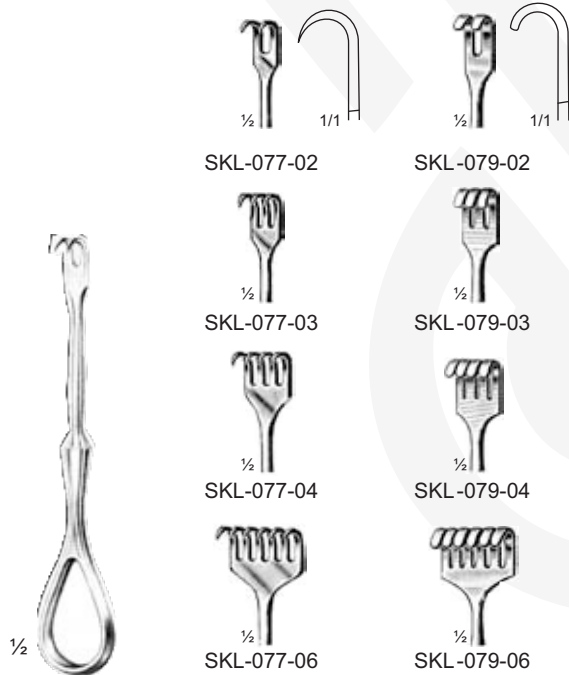

Volkmann
11.5 cm / 4½"

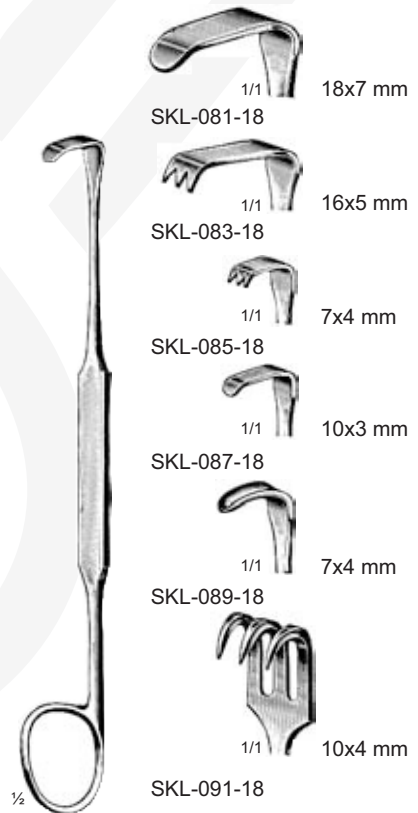

Meyerding
18 cm / 7"

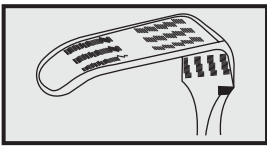

Flexible

1/2

16 cm / 6 1/4"

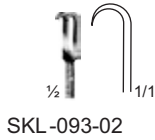

SKL-093-02



SKL-093-03



SKL-093-04



SKL-095-02

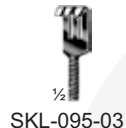

SKL-095-03

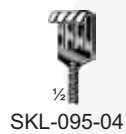

SKL-095-04



1/2

17 cm / 6 3/4"



SKL-097-01

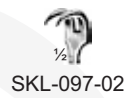

SKL-097-02

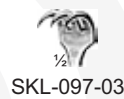

SKL-097-03



SKL-097-04



SKL-097-06



SKL-099-01



SKL-099-02



SKL-099-03



SKL-099-04



SKL-099-06



1/2

16 cm / 6 1/4"



SKL-101-01



SKL-101-02



SKL-101-03



SKL-101-04



1/2

16 cm / 6 1/4"



SKL-103-01



SKL-103-02



SKL-103-03



SKL-103-04



1/2

16 cm / 6 1/4"



SKL-105-01



SKL-105-02



SKL-105-03



SKL-105-04

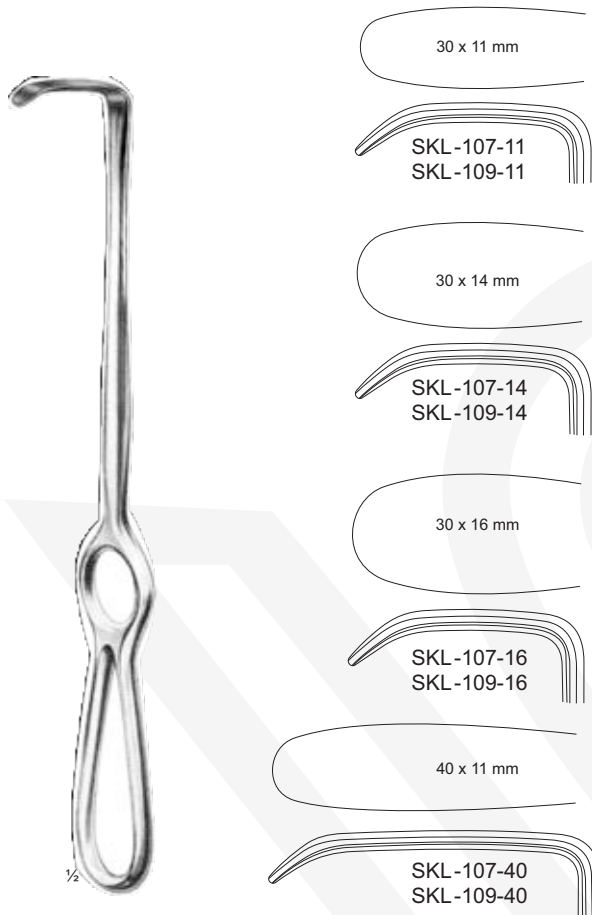
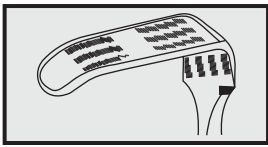

Langenbeck
21 cm / 8¼"
SKL-107-00



Langenbeck
21 cm / 8¼"

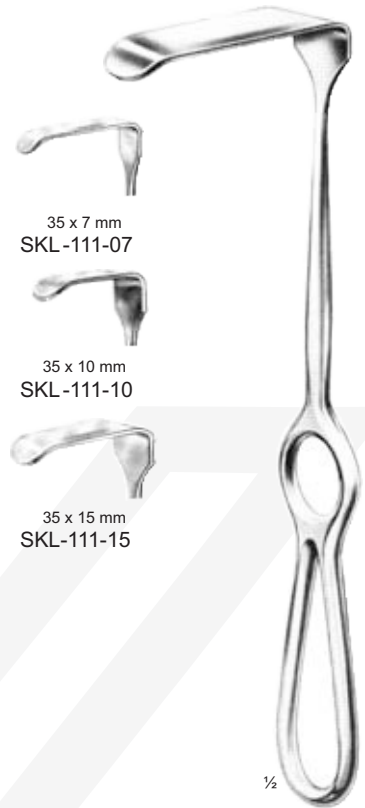

Langenbeck
22 cm / 8½"
SKL-111-22

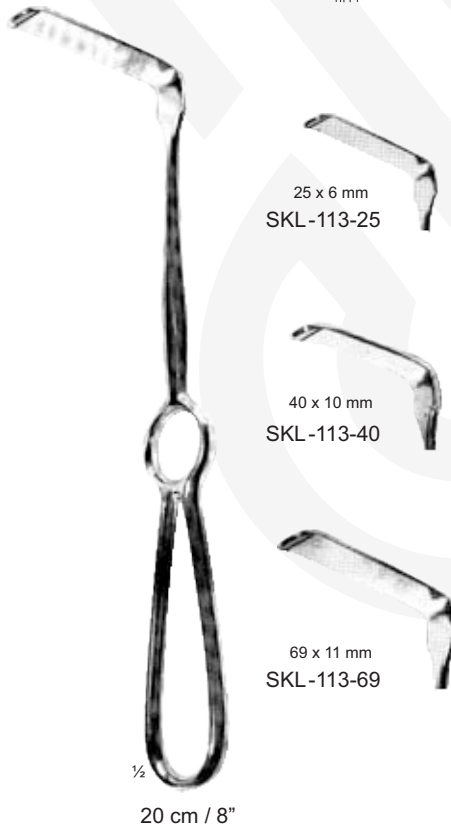

20 cm / 8"

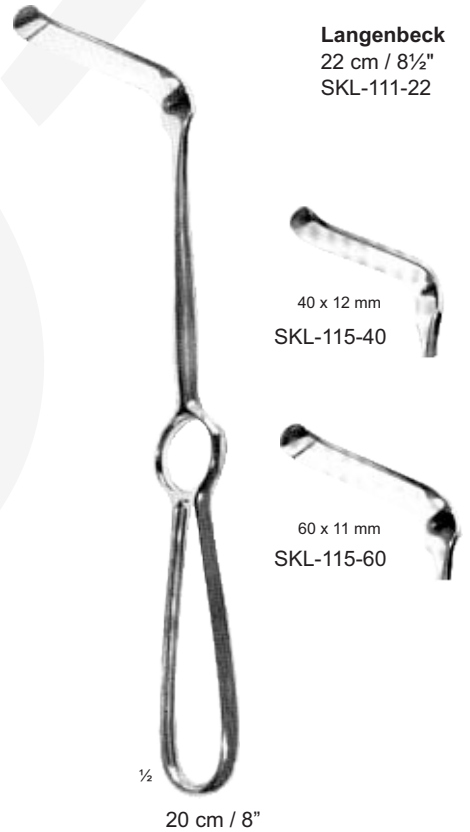

20 cm / 8"

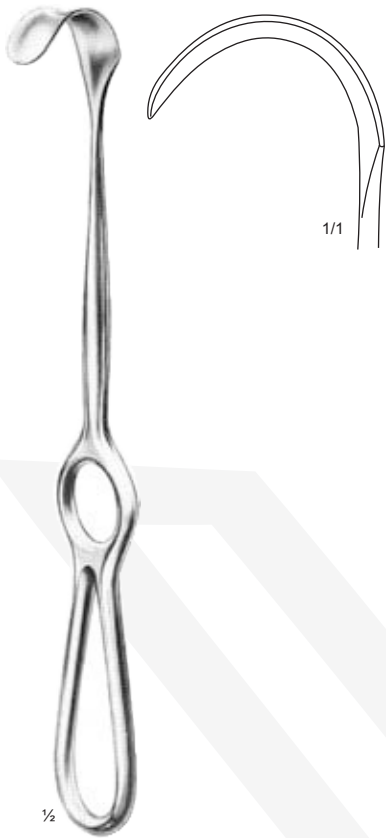
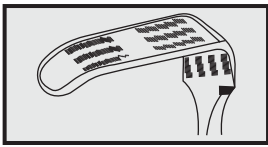

Kocher
22 cm / 8 3/4"
40 x 10 mm
SKL-117-10
40 x 15 mm
SKL-119-15

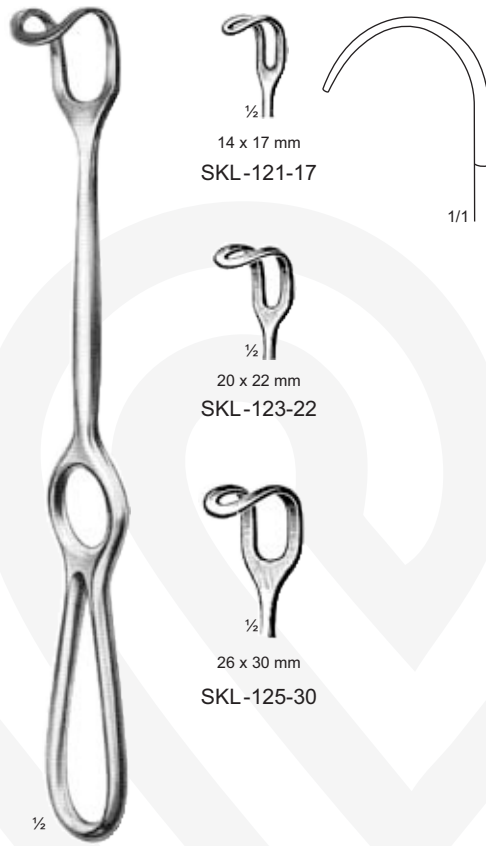

Middeldorpf

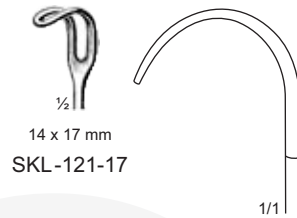

1/2
14 x 17 mm
SKL-121-17

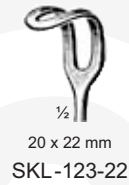

1/2
20 x 22 mm
SKL-123-22



1/2
26 x 30 mm
SKL-125-30



Middeldorpf

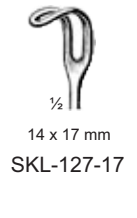

1/2
14 x 17 mm
SKL-127-17

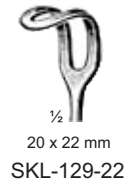

1/2
20 x 22 mm
SKL-129-22



1/2
26 x 30 mm
SKL-131-30



SKL-133-01



SKL-135-01



Shann
SKL-137-01

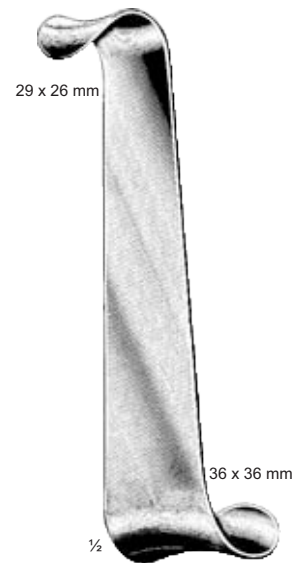

Roux Magnus
SKL-139-01

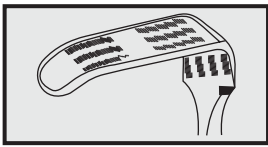

SKL-141-01
25 x 6 mm



SKL-141-05
35 x 15 mm



SKL-141-02
25 x 8 mm

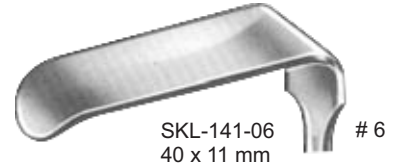

SKL-141-06
40 x 11 mm



SKL-141-03
35 x 8 mm



SKL-141-07
55 x 11 mm



SKL-141-04
35 x 11 mm



SKL-141-08
70 x 14 mm



SKL-141-09
80 x 12 mm

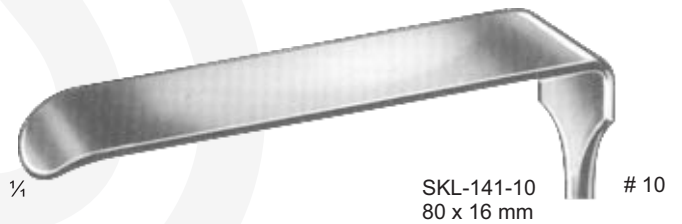

SKL-141-10
80 x 16 mm



Kocher-Langenbeck
21.5cm/8 1/2"

also available in special sizes

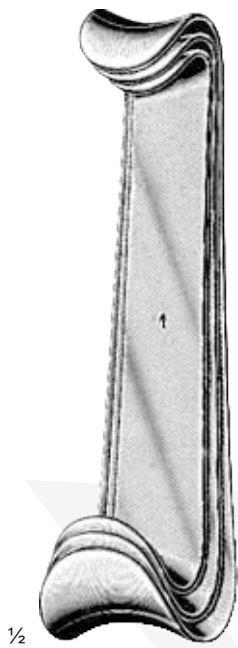
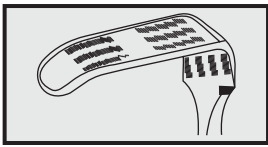

1/2

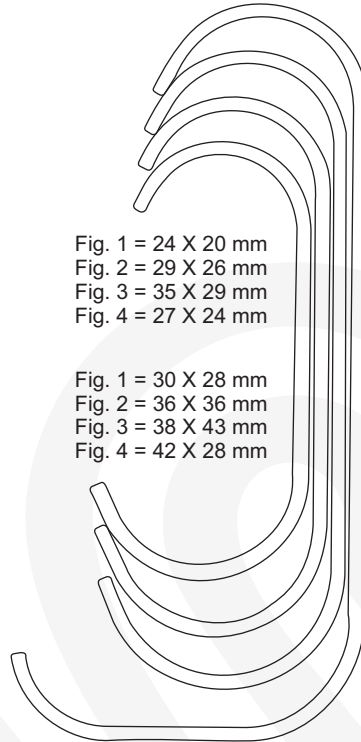

Fig. 1 = 24 X 20 mm
 Fig. 2 = 29 X 26 mm
 Fig. 3 = 35 X 29 mm
 Fig. 4 = 27 X 24 mm

Fig. 1 = 30 X 28 mm
 Fig. 2 = 36 X 36 mm
 Fig. 3 = 38 X 43 mm
 Fig. 4 = 42 X 28 mm

Roux

SKL-143-00 = Set Fig. 1-3
 SKL-143-01 = Fig. 1 = 14 cm/5 1/2"
 SKL-143-02 = Fig. 2 = 15 cm/6"
 SKL-143-03 = Fig. 3 = 17 cm/6 3/4"
 SKL-143-04 = Fig. 4 = 18 cm/7"

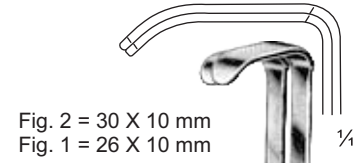

Fig. 2 = 30 X 10 mm
 Fig. 1 = 26 X 10 mm

Fig. 1 = 30 X 13 mm
 Fig. 2 = 34 X 13 mm

Farabeuf

SKL-145-00 = Set
 SKL-145-01 = Fig. 1
 SKL-145-02 = Fig. 2
 12 cm/4 3/4"

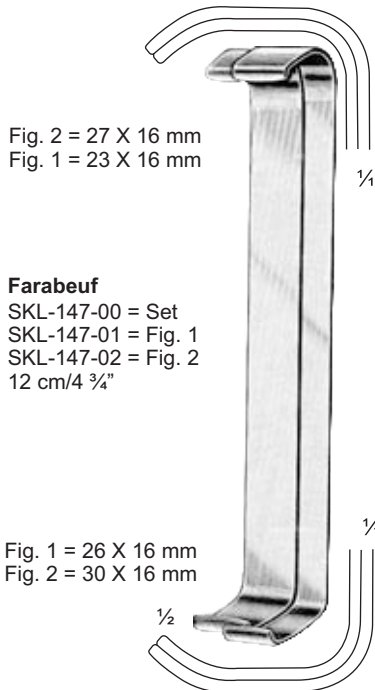

Fig. 2 = 27 X 16 mm
 Fig. 1 = 23 X 16 mm

Farabeuf

SKL-147-00 = Set
 SKL-147-01 = Fig. 1
 SKL-147-02 = Fig. 2
 12 cm/4 3/4"

Fig. 1 = 26 X 16 mm
 Fig. 2 = 30 X 16 mm



Mini-Roux
 SKL-149-06

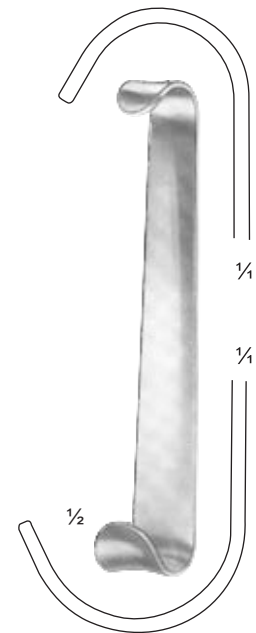

Baby-Roux
 SKL-151-13
 13 cm/5 1/4"

SKKYLINE

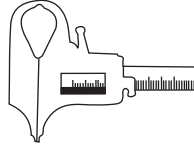

SUTURES, SUCTION TUBES & MEASURING TOOLS





Standard

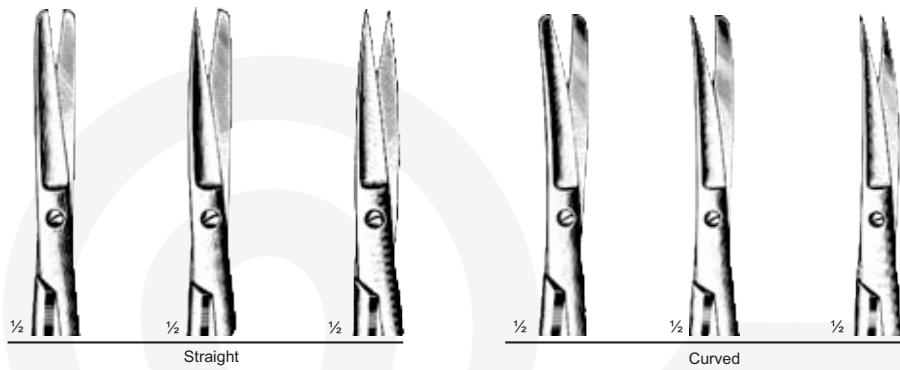

cm	in	SKL-001-10	SKL-003-10	SKL-005-10	SKL-007-10	SKL-009-10	SKL-011-10
10.5	4¼	SKL-001-10	SKL-003-10	SKL-005-10	SKL-007-10	SKL-009-10	SKL-011-10
11.5	4½	SKL-001-11	SKL-003-11	SKL-005-11	SKL-007-11	SKL-009-11	SKL-011-11
13	5	SKL-001-13	SKL-003-13	SKL-005-13	SKL-007-13	SKL-009-13	SKL-011-13
14.5	5½	SKL-001-14	SKL-003-14	SKL-005-14	SKL-007-14	SKL-009-14	SKL-011-14
15.5	6	SKL-001-15	SKL-003-15	SKL-005-15	SKL-007-15	SKL-009-15	SKL-011-15
16.5	6½	SKL-001-16	SKL-003-16	SKL-005-16	SKL-007-16	SKL-009-16	SKL-011-16



Graziol

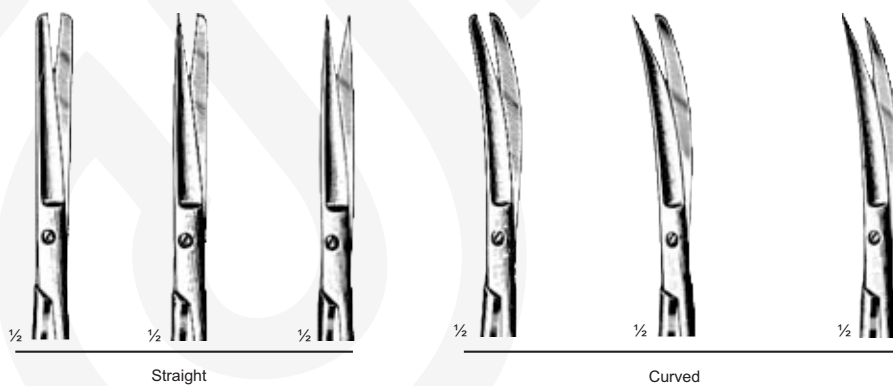

cm	in	SKL-013-13	SKL-015-13	SKL-017-13	SKL-019-13	SKL-021-13	SKL-023-13
13	5	SKL-013-13	SKL-015-13	SKL-017-13	SKL-019-13	SKL-021-13	SKL-023-13
14.5	5½	SKL-013-14	SKL-015-14	SKL-017-14	SKL-019-14	SKL-021-14	SKL-023-14

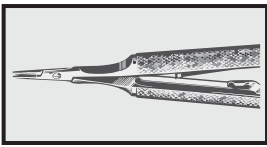

1/3	cm	in	SKL-001-01	SKL-001-02	SKL-001-03	SKL-001-04	1/3
	19.5	7¾	SKL-003-01	SKL-003-02	SKL-003-03	SKL-003-04	
	22.5	8¾					

Reverdin

Reverdin

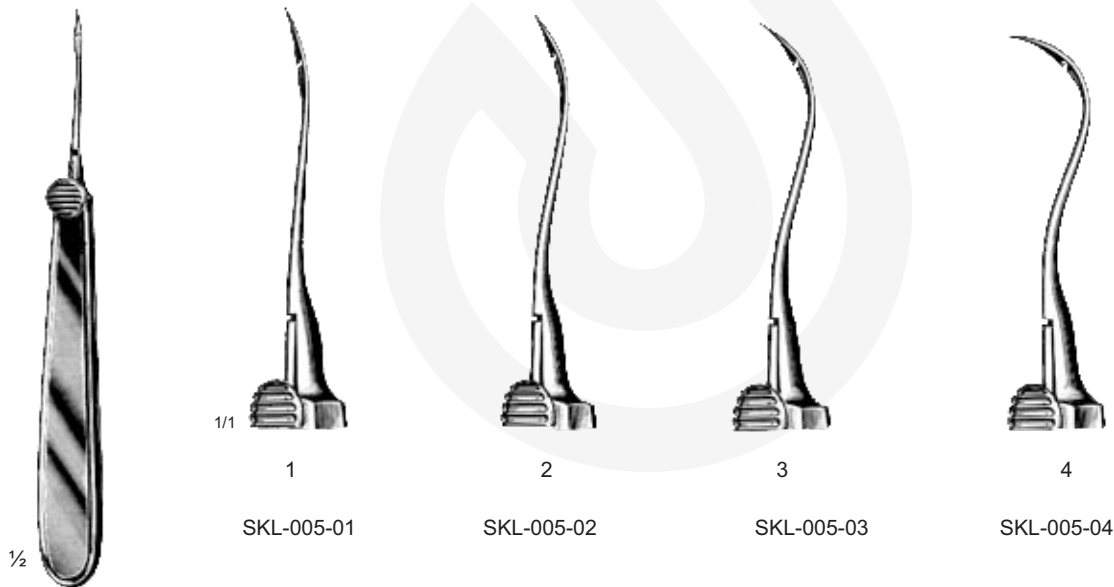

1/2	SKL-005-01	SKL-005-02	SKL-005-03	SKL-005-04
-----	------------	------------	------------	------------

Reverdin
14 cm / 5½"

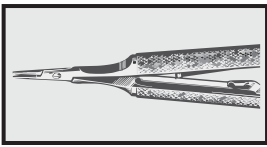

Mayo-Hegar

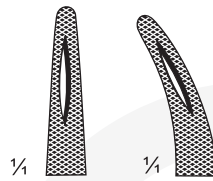

cm	in.	straight	curved
14	5 1/2	SKL-007-14	
16	6 1/4	SKL-007-16	SKL-009-16
18	7	SKL-007-18	SKL-009-18
20	8	SKL-007-20	SKL-009-20
24	9 1/2	SKL-007-24	SKL-009-24
26	10 1/4	SKL-007-26	SKL-009-26
30	12	SKL-007-30	

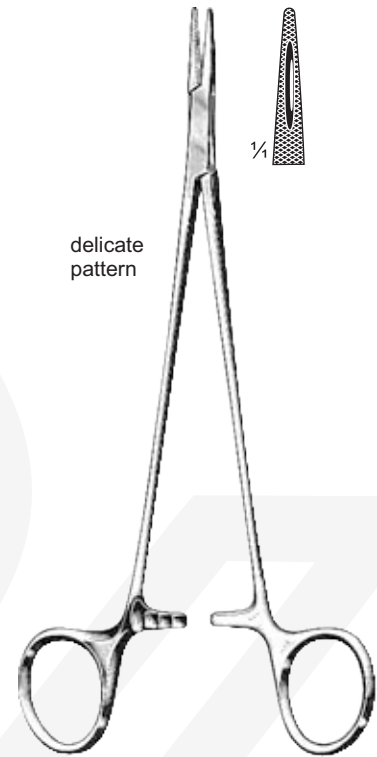

delicate pattern

Mayo-Hegar
 SKL-011-16 = 16cm/6 1/4"
 SKL-011-18 = 18cm/7"
 SKL-011-20 = 30cm/8"

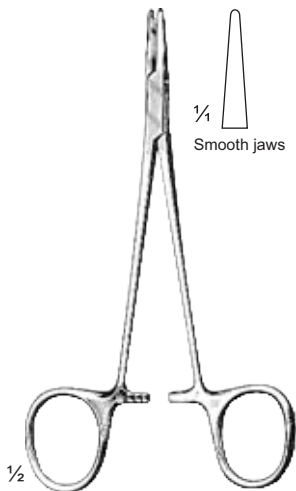

Halsey
 SKL-013-13
 13 cm / 5"

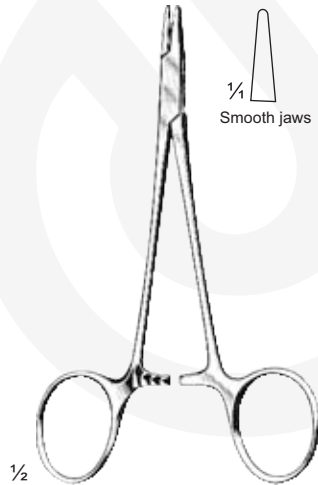

Webster
 SKL-015-13
 13 cm / 5"



Crile-Murray
 SKL-017-15
 15 cm / 6"

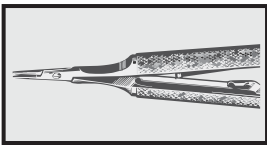

Crile-Wood
SKL-019-15
15 cm / 6"

Crile
SKL-021-15
15 cm / 6"

Toennis
SKL-023-18
18 cm / 7"

Castroviejo

SKL-025-13
13cm/5"
curved

SKL-025-13
13cm/5"
straight

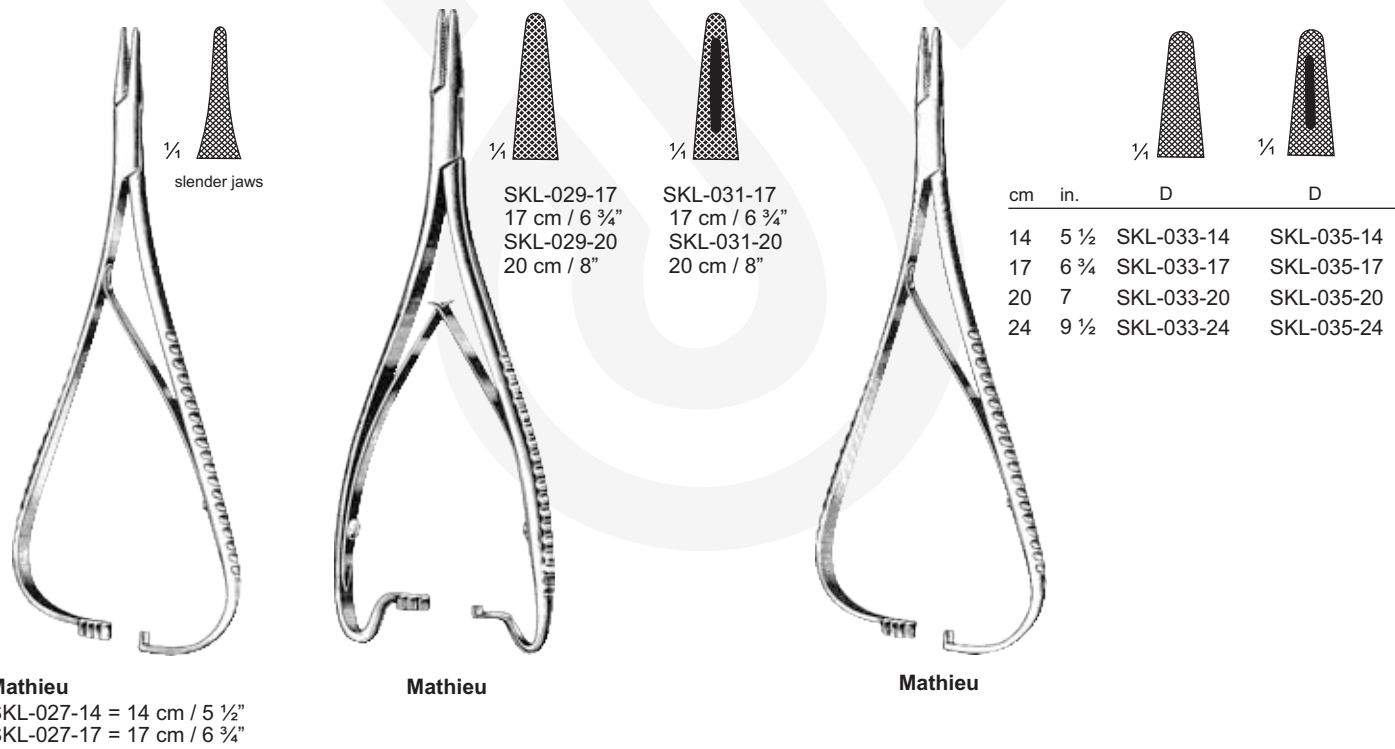

Mathieu
SKL-027-14 = 14 cm / 5 1/2"
SKL-027-17 = 17 cm / 6 3/4"

Mathieu

Mathieu

SKL-029-17
17 cm / 6 3/4"
SKL-029-20
20 cm / 8"

SKL-031-17
17 cm / 6 3/4"
SKL-031-20
20 cm / 8"

cm	in.	D	D
14	5 1/2	SKL-033-14	SKL-035-14
17	6 3/4	SKL-033-17	SKL-035-17
20	7	SKL-033-20	SKL-035-20
24	9 1/2	SKL-033-24	SKL-035-24

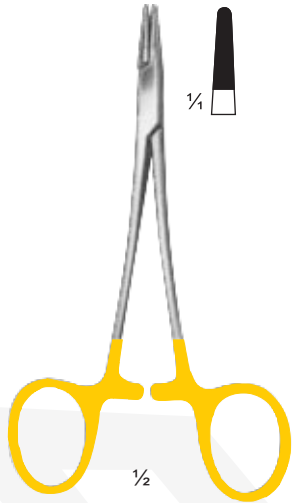
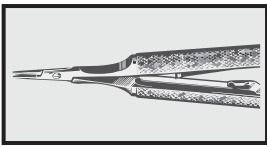

Webster
SKL-037-13
13cm/5"



Baumgartner
SKL-039-13
13cm/5"



Derf (Halsey)
SKL-041-12
12cm/4 3/4"



Derf (Halsey)



Crile-Wood

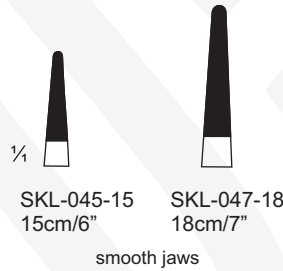

SKL-045-15 15cm/6"
SKL-047-18 18cm/7"
smooth jaws

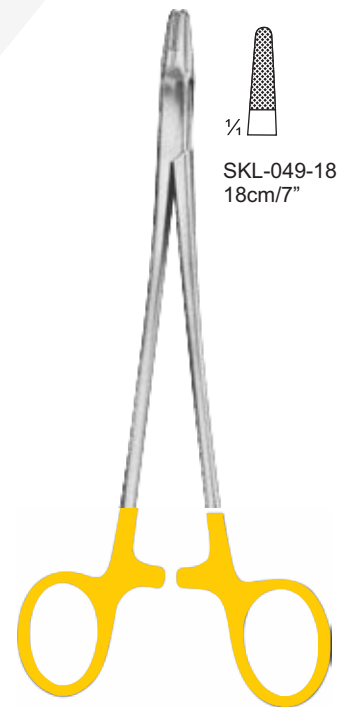

New Orleans

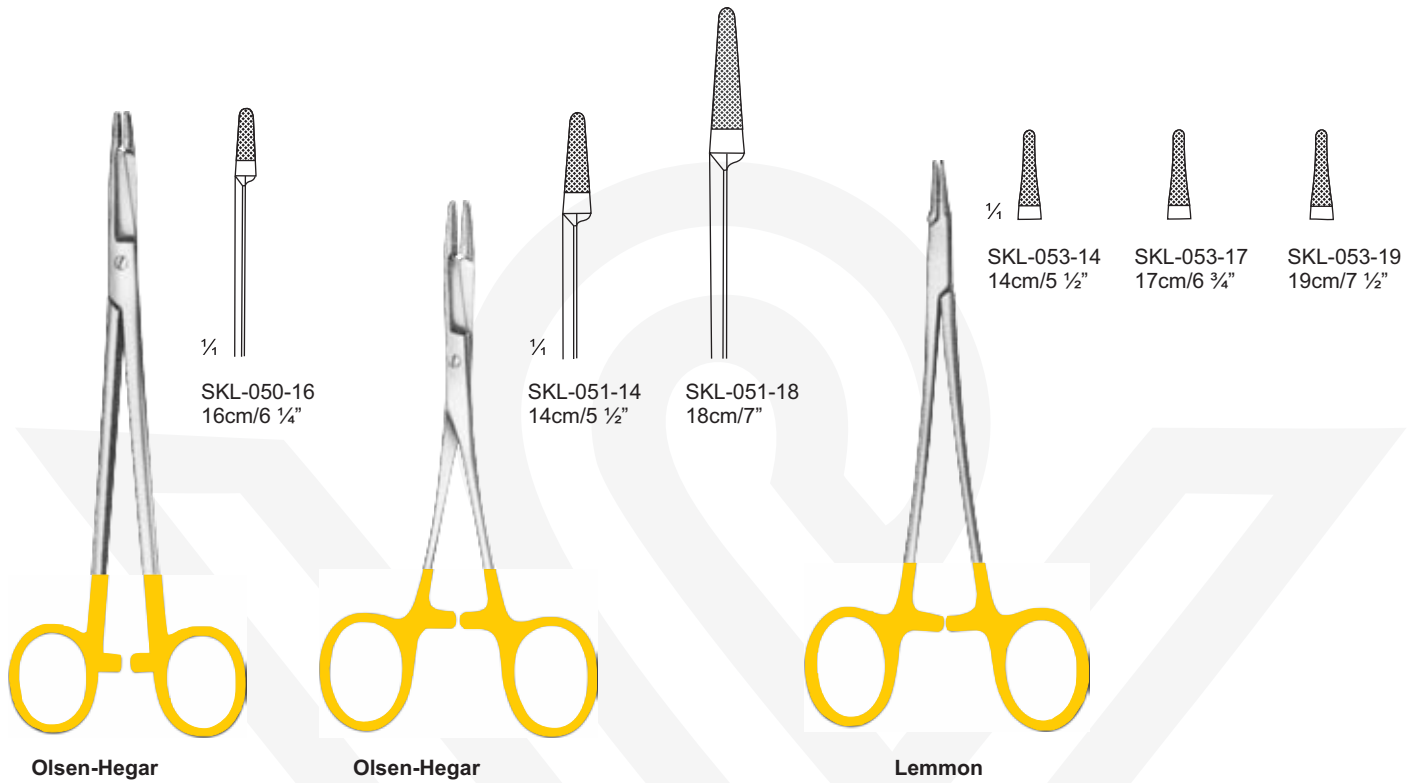
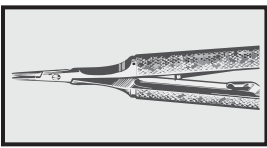

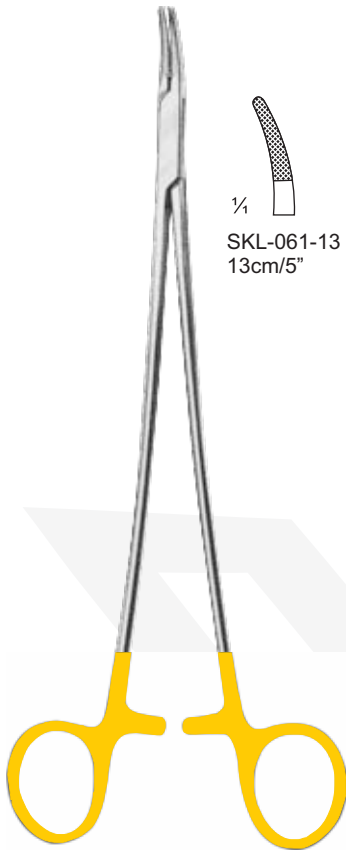
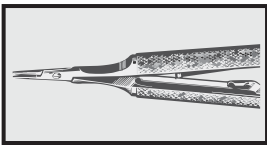

Crile-Wood

- SKL-061-13
13cm/5"
- SKL-061-15
15cm/6"
- SKL-061-18
18cm/7"
- SKL-061-20
20cm/8"
- SKL-061-23
23cm/9"



Mayo-Hegar

- SKL-063-14
14cm/5 1/2"
- SKL-063-16
16cm/6 1/4"
- SKL-063-18
18cm/7"
- SKL-063-20
20cm/8"
- SKL-063-23
23cm/9"
- SKL-063-26
26cm/10 1/4"
- SKL-063-30
30cm/12"



Crile Wood

- SKL-065-15
15cm/6"
- SKL-065-18
18cm/7"



Crile-Wood (Newman)

- SKL-067-15
15cm/6"
- SKL-067-18
18cm/7"
- SKL-067-20
20cm/8"
- SKL-067-23
23cm/9"
- SKL-067-26
26cm/10 1/4"

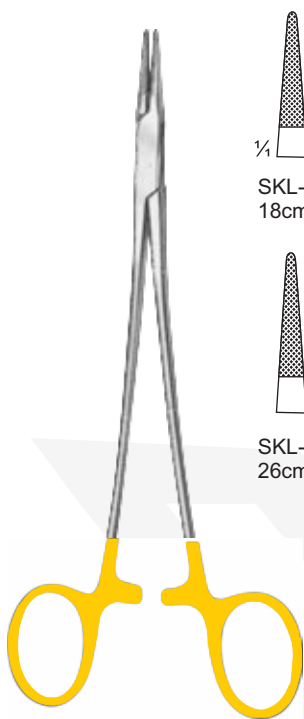
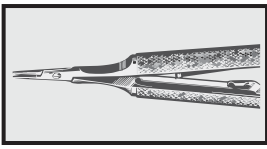

DeBakey

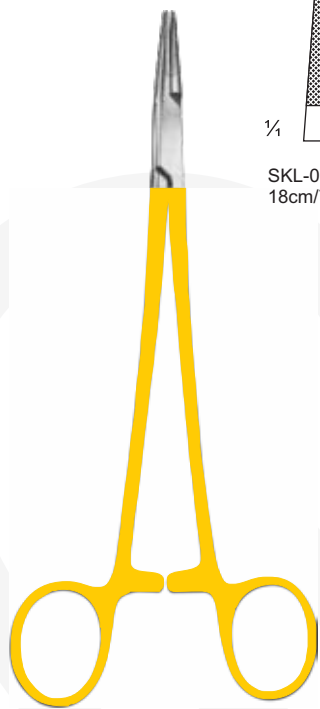
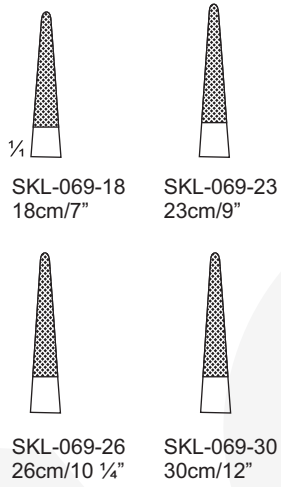

DeBakey

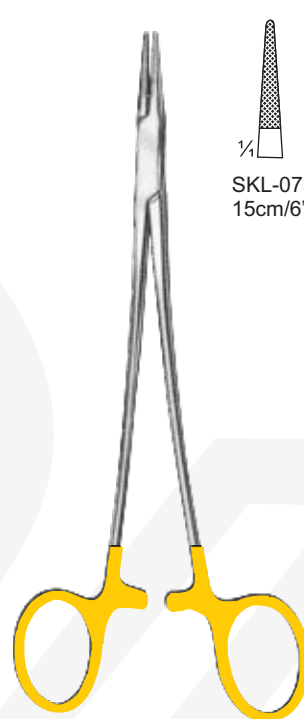
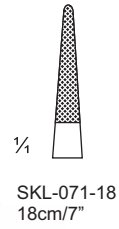

Micro-Vascular

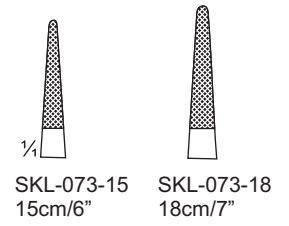

Mathieu-Stillé

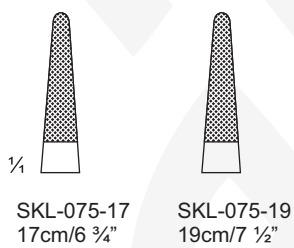

Metzenbaum

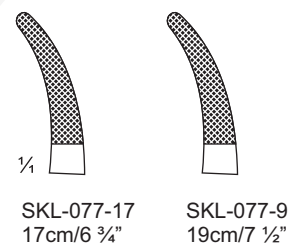

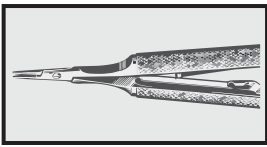

SKL-079-19
19cm/7 1/2"

Tönnies



SKL-081-14
14cm/5 1/2"

Lichtenberg

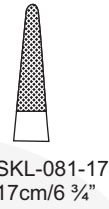

SKL-081-17
17cm/6 3/4"

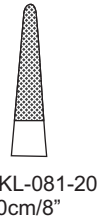

SKL-081-20
20cm/8"

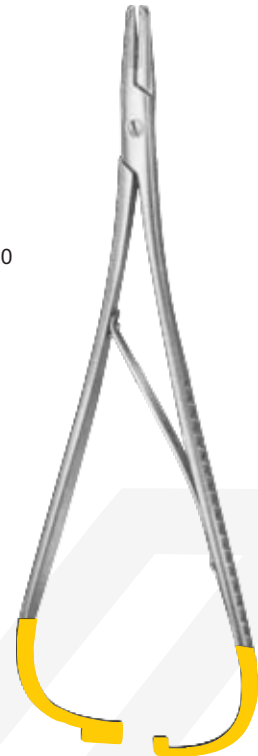

SKL-083-20
20cm/8"

Mathieu

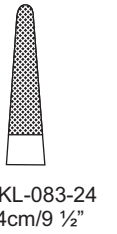

SKL-083-24
24cm/9 1/2"



SKL-085-14
14cm/5 1/2"

Mathieu

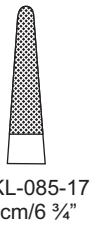

SKL-085-17
17cm/6 3/4"

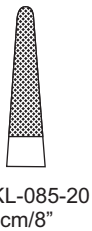

SKL-085-20
20cm/8"



SKL-087-20
20cm/8"

Zweifel

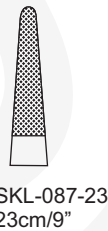

SKL-087-23
23cm/9"



SKL-091-16
16cm/6 1/4"

Langenbeck

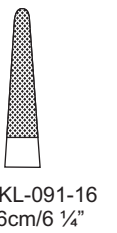

SKL-091-16
16cm/6 1/4"

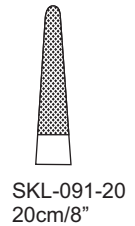

SKL-091-20
20cm/8"

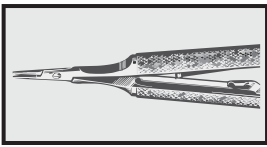

SKL-093-13
13cm/5"
solid serration

SKL-095-13
13cm/5"
solid serration

SKL-097-13
13cm/5"
micro fine serration

SKL-099-13
13cm/5"
micro fine serration



SKL-101-13
13cm/5"
solid serration

SKL-103-13
13cm/5"
micro fine serration



Arruga
DC32-105-16
16 cm/6 1/4"

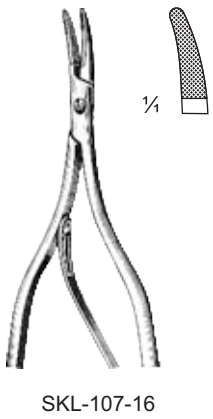

SKL-107-16



Castroviejo

solid serration

SKL-109-18
18cm/7"

SKL-111-18
18cm/7"

SKL-113-20
20cm/8"

SKL-115-20
20cm/8"

micro fine serration

SKL-117-18
18cm/7"

SKL-119-18
18cm/7"

SKL-121-20
20cm/8"

SKL-123-20
20cm/8"

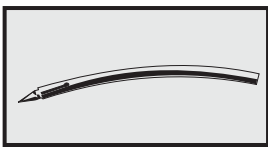

Lichtwitz
1.75 mm ø
SKL-125-17



Lichtwitz
2 mm ø
SKL-127-22



Pierce
SKL-129-3 mmø
SKL-129-4 mmø
SKL-129-5 mmø

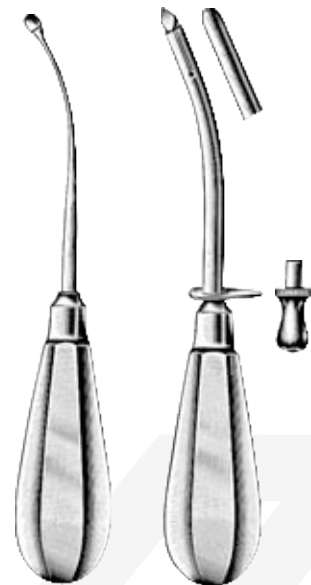

Krause
5.5 mm ø
SKL-131-55



Yankauer
SKL-132-T



0
SKL-133-10



1
SKL-133-11



2
SKL-133-12



3
SKL-133-13

SKL-133-02



Yankauer
SKL-133-01



Schimmelbusch
SKL-135-01



Metzenbaum
14.5 cm / 5 1/2"



Metzenbaum-Nelson
18 cm / 7"



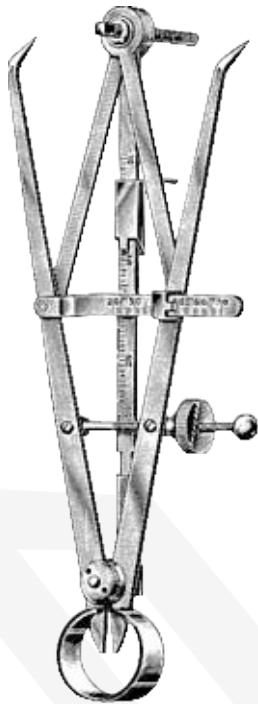
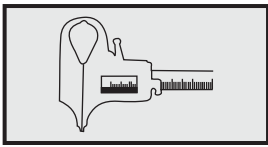

Korkhaus
SKL-137-01



18.5 cm / 7 1/4"
SKL-139-18



12 cm / 4 3/4"
SKL-141-12



SKL-143-01

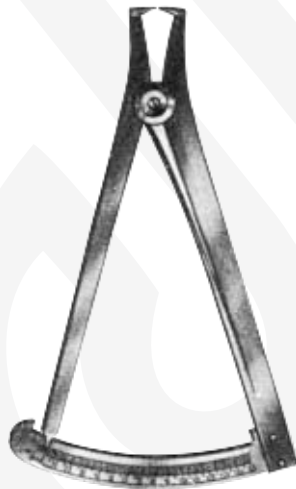

Measuring range 0-15 mm
SKL-145-15



Measuring range 0-10 mm
SKL-147-10

SKL-137-01	Three dimensional Caliper
SKL-139-18	Bow space for orthodontic work
SKL-141-12	Dividing Compass
SKL-143-01	Bow Compass
SKL-145-15	Decimal spring Caliper
SKL-147-10	Decimal spring Caliper

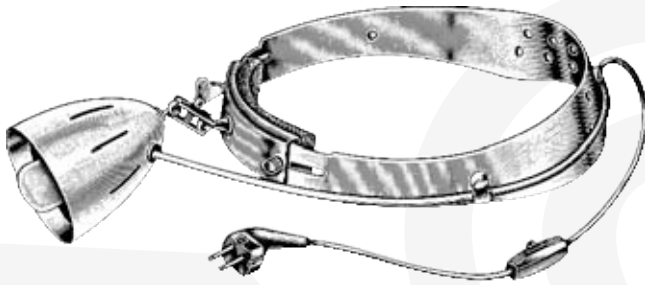
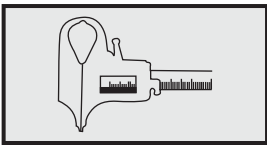

Orion
SKL-149-01

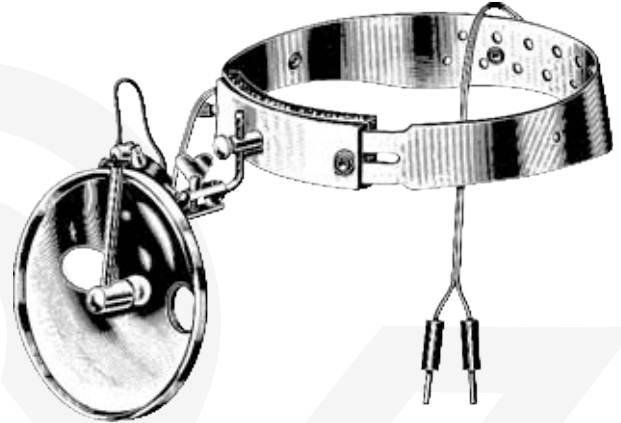

Clar
SKL-151-01

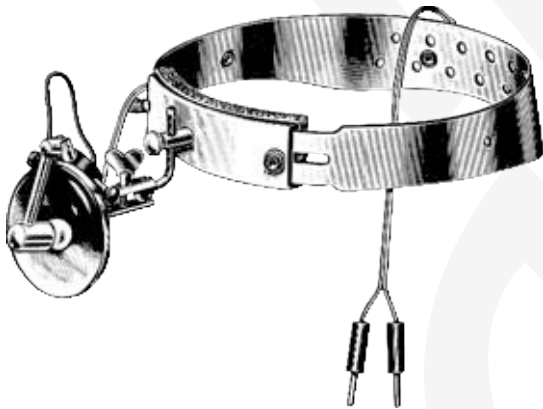

Clar-mini
SKL-153-01



11.5 cm / 4 1/2"
SKL-155-11



11.5 cm / 4 1/2"
SKL-157-11



Boley
SKL-159-01

SKL-149-01	SKL-151-01	Head Lamp
	SKL-153-01	Head Lamp
SKL-155-11	SKL-157-11	Tail Voice
	SKL-159-01	Caliper

SKKYLINE

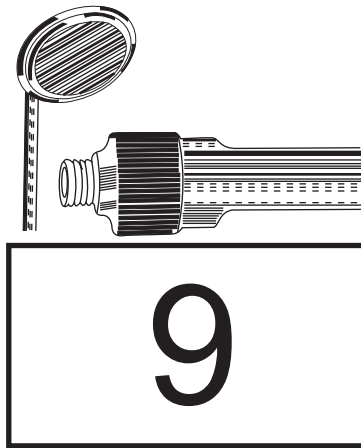

DENTAL MIRROR & SYRINGES

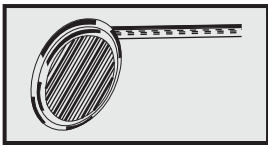

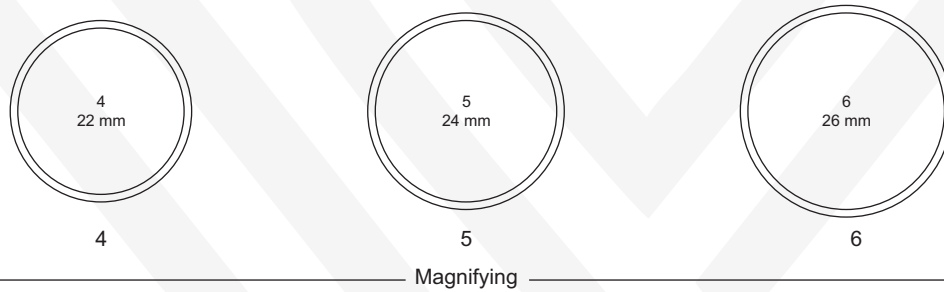
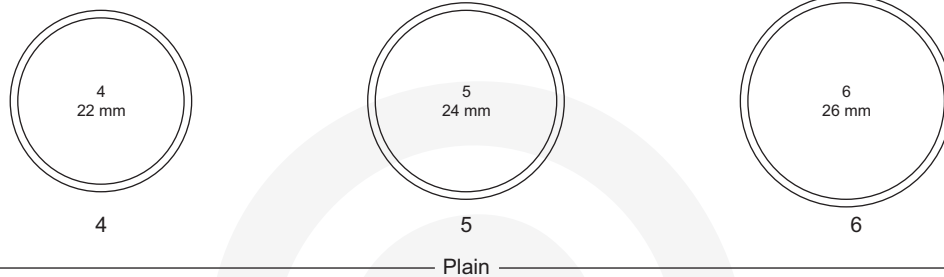
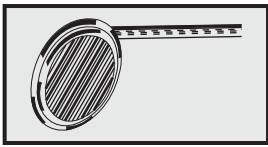

4 5 6
Plain

A	SKL-001-04	SKL-011-05	SKL-021-06
B	SKL-003-04	SKL-013-05	SKL-023-06
C	SKL-005-04	SKL-015-05	SKL-025-06
D	SKL-007-04	SKL-017-05	SKL-027-06
E	SKL-009-04	SKL-019-05	SKL-029-06

4 5 6
Magnifying

A	SKL-031-04	SKL-041-05	SKL-051-06
B	SKL-033-04	SKL-043-05	SKL-053-06
C	SKL-035-04	SKL-045-05	SKL-055-06
D	SKL-037-04	SKL-047-05	SKL-057-06
E	SKL-039-04	SKL-049-05	SKL-059-06

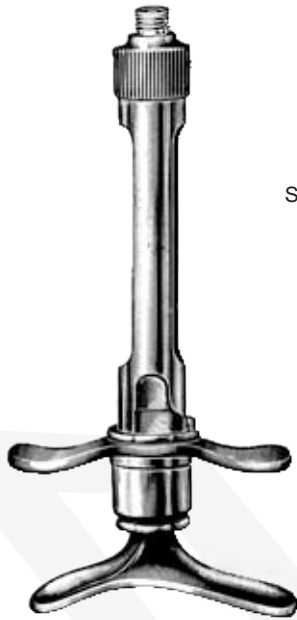
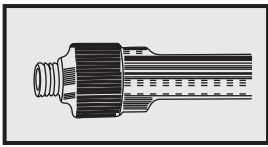

SKL-141-00
Cartridge Syringe



SKL-143-01



SKL-143-02



SKL-145-00



SKL-161-00



SKL-163-00



SKL-155-03
Cannulas



SKL-157-03
Cannulas



SKL-159-03
Cannulas

SKL-141-00	Cartridge Syringe	
SKL-145-00	Chip Blower Syringe with cannula and bulb	
SKL-155-03	SKL-159-03	Cannula for above
SKL-161-00	SKL-163-00	Metal Syringe

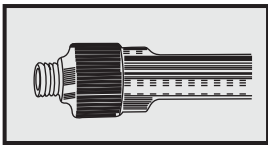

SKL-165-00



SKL-167-00



SKL-169-00



SKL-171-00



SKL-173-00



SKL-175-00

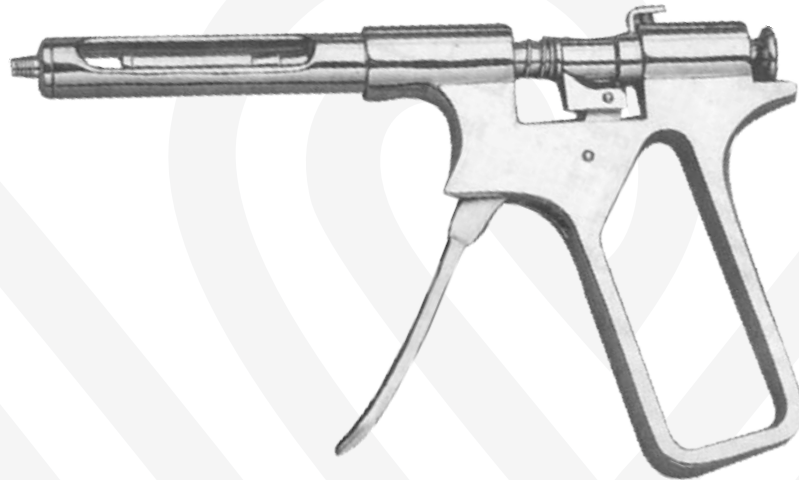
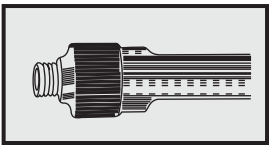

SKL-177-00



SKL-179-00

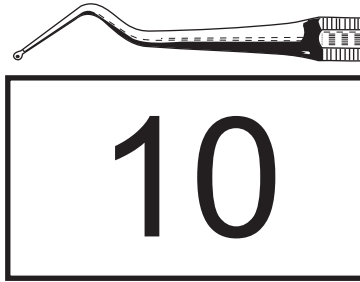

EXPLORERS

